

APX™ TWO-WAY RADIOS

APX 3000

USER GUIDE





ASTRO® APX™ 3000

Digital Portable Radios

Quick Reference Card

RF Energy Exposure and Product Safety Guide for Portable Two-Way Radios

ATTENTION!

This radio is restricted to **Occupational use only**. Before using the radio, read the RF Energy Exposure and Product Safety Guide for Portable Two-Way Radios which contains important operating instructions for safe usage and RF energy awareness and control for Compliance with applicable standards and Regulations.

Radio Controls

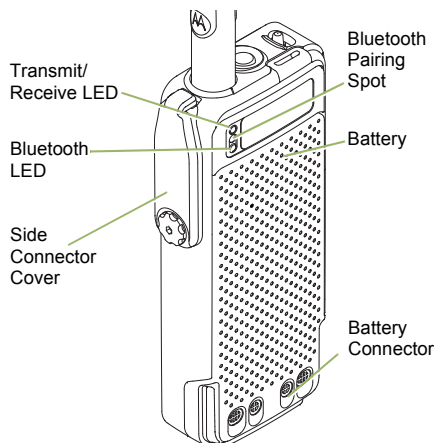
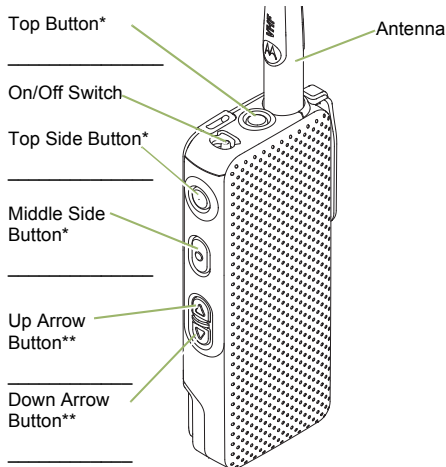

IMPORTANT!

You must connect a speaker microphone, earpiece or headset to hear the audio indicators; and a **GCAI DRSM** to see the strings and icons of your radio.

Turning Radio On/Off

- **On** – Push the **On/Off Switch** downwards. You see a Green Dot.
- **Off** – Push the **On/Off Switch** upwards.

Control Buttons for Channels, Zone or Volume

- **Multi-Functional Button (MFB)*** – To toggle between **Volume**, **Channel** or **Zone** mode.
- **Up Arrow Button**** – To increase volume; to toggle the channels or zones up.

- **Down Arrow Button**** – To decrease volume; to toggle the channels or zones down.

*MFB can be programmed to **Top**, **Top Side** and **Middle Side** button. It can be configured to support two features out of **Volume**, **Channel** or **Zone** mode.

Making a Call

- 1 Press the **Multi-Functional Button*** to the desirable channel or zone mode.
- 2 Press the **Up/Down Arrow Button** to change the channel/zone.
- 3 Adjust volume, if necessary.
- 4 Press the **PTT** button to transmit; release to receive.

You may hear Channel Voice Announcement upon entering channel or zone mode if preprogrammed.

Sending an Emergency Alarm

- 1 Press and release the **Emergency button*****.
- 2 When acknowledgment is received, you hear four beeps; alarm ends; and radio exits emergency.

*****Default emergency button press timer is set to 1 second.** This timer is programmable, see page 41 in the user guide for details. To exit emergency at any time, press and hold the **Emergency** button.



PMLN6407B



English

■ Sending an Emergency Call

- 1 Press the **Emergency** button.
- 2 Press and hold the **PTT** button. Speak clearly with the microphone near your mouth.
- 3 Release the **PTT** button to end call.
- 4 Press and hold **Emergency** button to exit emergency.

*To exit emergency at any time, press and hold the **Emergency** button.*

■ Sending a Silent Emergency Alarm

- 1 Press the **Emergency** button.
- 2 The LED does not light up, and there is no tone.
- 3 Silent emergency continues until you press and hold the **Emergency** button to exit emergency state.
OR
Press and release the **PTT** button to exit the Silent Emergency Alarm mode and enter regular dispatch or Emergency Call mode.

*To exit emergency at any time, press and hold the **Emergency** button.*

■ LED Indicator

Solid red	Radio is transmitting.
Blinking red	Radio is transmitting at low battery condition.
Rapid blinking red	Power-Up failure.

Solid green	Radio has completed power up.
Blinking blue (3 Blinks)	Bluetooth is powering On/ Off.
Slow blinking blue	Bluetooth is ready to pair.
Rapid blinking blue for two seconds	Bluetooth fails to connect or disconnect from a device.
Solid blue for two seconds	Bluetooth device is connected or disconnected.
Solid blue	Bluetooth error.
Blinking blue at heartbeat pace	Radio is connected with at least one Bluetooth accessory device.

■ Bluetooth Pairing with Mission Critical Wireless Pod

- 1 To hear audio indications, plug the earpiece into the Wireless Pod.
OR
To function as a Standalone PTT Device, remove the earpiece.
- 2 Power on both your radio and Pod.
- 3 Ensure the Bluetooth feature of your radio and Pod are enabled. Ensure the Pod is in pairing mode.
- 4 Place the Bluetooth pairing spot of your Pod within one inch from the Bluetooth pairing spot on your radio.

Audio indications include alert tones and Voice Announcement (feature enabled via CPS).

■ Bluetooth Pairing with Mission Critical Wireless Remote Control Unit (RCU)

- 1 Verify that both your radio and your RCU are powered ON and in pairing mode.
- 2 To enter pairing mode on your RCU, press and hold the Trunk button while powering up the RCU.
- 3 Place the Bluetooth pairing spot on your RCU within one inch of the Bluetooth pairing spot on your radio.
- 4 Radio LED turns solid blue for two seconds and then blinking blue at heartbeat pace to indicate connection is successfully established.

PMLN6233_ Discreet Mission Critical Wireless RCU is recommended to use with your APX 3000 as it provides additional functionality to this radio.

■ Connecting to Display Remote Speaker Microphone (DRSM)

- 1 Turn off your Radio.
- 2 Align and attach the RSM's connector to your radio's side connector.
- 3 Secure by tightening the screw on the lower end of the connector.

Only DRSM supports the APX 3000 display capability.

Declaration of Conformity

This declaration is applicable to your radio **only** if your radio is labeled with the FCC logo shown below.

<p>DECLARATION OF CONFORMITY Per FCC CFR 47 Part 2 Section 2.1077(a)</p> <p style="text-align: center;"></p> <p>Responsible Party Name: Motorola Solutions, Inc. Address: 1303 East Algonquin Road, Schaumburg, Illinois 60196, U.S.A. Phone Number: 1-800-927-2744</p> <p>Hereby declares that the product: Model Name: APX 3000</p> <p>conforms to the following regulations: FCC Part 15, subpart B, section 15.107(a), 15.107(d) and section 15.109(a)</p> <p>Class B Digital Device</p> <p>As a personal computer peripheral, this device complies with Part 15 of the FCC Rules. Operation is subject to the following two conditions:</p> <ol style="list-style-type: none">1. This device may not cause harmful interference, and2. This device must accept any interference received, including interference that may cause undesired operation.
--

Note: This equipment has been tested and found to comply with the limits for a Class B digital device, pursuant to part 15 of the FCC Rules. These limits are designed to provide reasonable protection against harmful interference in a residential installation. This equipment generates, uses and can radiate radio frequency energy and, if not installed and used in accordance with the instructions, may cause harmful interference to radio communications. However, there is no guarantee that interference will not occur in a particular installation.

If this equipment does cause harmful interference to radio or television reception, which can be determined by turning the equipment off and on, the user is encouraged to try to correct the interference by one or more of the following measures:

- Reorient or relocate the receiving antenna.
- Increase the separation between the equipment and receiver.
- Connect the equipment into an outlet on a circuit different from that to which the receiver is connected.
- Consult the dealer or an experienced radio/TV technician for help.

Contents

This User Guide contains all the information you need to use the APX™ 3000 Series Digital Portable Radios.

Declaration of Conformity i

Important Safety Information viii

RF Energy Exposure and Product Safety Guide for Portable Two-Way Radios viii

Software Version ix

Notice to Users (FCC and Industry Canada) ix

Informations importantes sur la sécurité x

Exposition aux radiofréquences et sécurité du produit pour radios bidirectionnelles portatives x

Versión du logiciel xi

Avis aux utilisateurs (FCC et Industrie Canada) xi

Computer Software Copyrights xii

Documentation Copyrights xii

Disclaimer xiii

Getting Started 1

How to Use This Guide 1

Notations Used in This Manual 1

Additional Performance Enhancement 2

CrossTalk Prevention 2

SecureNet 2

What Your Dealer/System Administrator

Can Tell You 2

Preparing Your Radio for Use 3

Charging the Battery 4

Battery Charger 4

Attaching the Battery† 5

Installing the Antenna 6

Attaching the Accessory Connector Cover 6

Installing Accessories with GCAI Connector 7

Turning On Your Radio‡ 7

Adjusting the Volume† 8

Pairing Radio with Pod and Earpiece†‡ 9

Pairing Radio with Mission Critical Remote Control

Unit (RCU) 10

- Using the Carry Holster 10
 - Inserting to the Carry Holster 10
 - Removing Your Radio from the Carry Holster 11
- Tying Your Radio and Flexible Antenna to Your Body 12
 - Positioning Your Radio and Devices on Your Body 12
 - Installing the Flexible Antenna 13
 - Strapping the Antenna onto Your Body 15
- Identifying Radio Controls16**
- Radio Parts and Controls 17
- Programmable Features 18
 - Assignable Radio Functions 18
 - Assignable Settings or Utility Functions 19
- Accessing the Preprogrammed Functions 19
 - Multi-Functional Button (MFB) 19
- Using Push-To-Talk (PTT) Button† 20
- Identifying Status Indicators21**
- Status Icons‡ 21
- LED Indicator 23
 - LED Indicators in Surveillance Mode† 24
- Intelligent Lighting Indicators‡ 25
- Alert Tones† 26

- General Radio Operation 29**
- Selecting a Zone† 29
- Selecting a Radio Channel† 30
- Using Mode Select Feature 31
 - Saving a Zone and Channel to a Mode Select Button†31
- Receiving and Responding to a Radio Call 32
 - Receiving and Responding to a Call‡32
 - Receiving and Responding to a Private Call (Trunking Only)†‡33
 - Receiving and Responding to a Telephone Call (Trunking Only)†‡33
- Making a Radio Call† 34
- Repeater or Direct Operation 34
- Monitoring Features†‡ 35
 - Monitoring a Channel35
 - Conventional Mode Operation35
- Advanced Features 36**
- Advanced Call Features 36
 - Receiving and Responding to a Selective Call (Conventional Only)†‡36
 - Using the Dynamic Regrouping Feature (Trunking Only)†‡37
 - Requesting a Reprogram (Trunking Only)†‡ 37

Classifying Regrouped Radios	38	Secure Operations	48
Scan	38	Selecting Secure Transmissions††	48
Turning Scan On or Off†	38	Selecting Clear Transmissions††	48
Deleting a Nuisance Channel†	39	Managing Encryption	49
Restoring a Nuisance Channel	39	Loading an Encryption Key†	49
Call Alert Paging††	40	Using the Multikey Feature	49
Receiving a Call Alert Page	40	Erasing All the Selected Encryption Keys†	50
Emergency Operation††	40	Requesting an Over-the-Air Rekey (ASTRO Only)††	50
Sending an Emergency Alarm	41	MDC Over-the-Air Rekeying (OTAR) Page	51
Sending an Emergency Call (Trunking Only)	42	Infinite UKEK Retention	51
Sending an Emergency Alarm with Emergency Call	42	Hear Clear†	51
Sending a Silent Emergency Alarm	43	Using Radio Kill†	52
Changing Channels during Emergency	43	Using Direct Kill	52
Using the Emergency Keep-Alive Feature	43	Trunking System Controls††	52
Man Down††	44	Using the Failsoft System	52
Pre-Alert Timer	45	Going Out of Range	53
Post-Alert Timer	45	Using the Site Trunking Feature	53
Alerting Tones When Man Down Feature is Triggered	45	Mission Critical Wireless	
Triggering Emergency	46	- Bluetooth® -††	54
Alerting User When Man Down Enhanced is Triggered	46	Turning the Bluetooth On	54
Exiting Man Down Feature	47	Turning the Bluetooth Off	54
Re-Initiating Man Down	47	Re-Pair Timer	55
Testing the Man Down Feature	47	Bluetooth Drop Timer	56
		Pairing with LF MPP Pairing Feature	56
		Indicating the Bluetooth Connection is Lost	58
		Pairing with Standard Pairing Feature	58

- Searching and Pairing with the Bluetooth Device . 59
- Turning Bluetooth Visibility On . 59
- Receiving Pairing Request from other Devices . 60
- Turning the Bluetooth Audio On (Routing the Audio from Your Radio to the Headset) . 60
- Turning the Bluetooth Audio Off (Routing the Audio from the Headset to Your Radio) . 60
- Adjusting the Volume of Your Radio from Bluetooth Audio Device . 60
- Clearing All Bluetooth Devices Information . 61
- Programming Over Project 25 (POP 25) (ASTRO 25 and ASTRO Conventional) . 61
- Voice Announcement† . 62
- Using Site Selectable Alerts (ASTRO 25)†‡ . 63
- Utilities . 63
 - Flipping the Display on DRSM‡ . 63
 - Controlling the Display Backlight‡ . 63
 - Locking and Unlocking the Controls†‡ . 64
 - Turning Voice Mute On or Off†‡ . 64
 - Using the Time-Out Timer . 65
 - Using the Conventional Squelch Operation Features . 65
 - Analog Options . 65
 - Digital Options . 65
 - Using the Digital PTT ID Feature‡ . 66
 - Using the Smart PTT Feature (Conventional Only) . 66

- Voice Announcement† . 67
- Helpful Tips . 68**
 - Troubleshooting . 68
 - Caring for Your Radio . 69
 - Cleaning Your Radio . 70
 - Handling Your Radio . 70
 - Servicing Your Radio . 71
 - Taking Care of the Battery†‡ . 71
 - Checking the Battery Charge Status . 71
 - LED and Sounds . 71
 - Fuel Gauge Icon . 71
 - Battery Recycling and Disposal . 72
- Accessories . 73**
 - Highlights for the Accessories . 73
- Appendix: Maritime Radio Use in the VHF Frequency Range . 74**
 - Special Channel Assignments . 74
 - Emergency Channel . 74
 - Non-Commercial Call Channel . 74
 - Operating Frequency Requirements . 75
 - Declaration of Compliance for the User of Distress and Safety Frequencies . 77

Glossary	78
Commercial Warranty	82

Important Safety Information

RF Energy Exposure and Product Safety Guide for Portable Two-Way Radios

ATTENTION!

This radio is restricted to Occupational use only. Before using the radio, read the RF Energy Exposure and Product Safety Guide for Portable Two-Way Radios which contains important operating instructions for safe usage and RF energy awareness and control for Compliance with applicable standards and Regulations.

For a list of Motorola-approved antennas, batteries, and other accessories, visit the following website:

<http://www.motorolasolutions.com/APX>

Under Industry Canada regulations, this radio transmitter may only operate using an antenna of a type and maximum (or lesser) gain approved for the transmitter by Industry Canada. To reduce potential radio interference to other users, the antenna type and its gain should be so chosen that the equivalent isotropically radiated power (e.i.r.p.) is not more than that necessary for successful communication.

This radio transmitter has been approved by Industry Canada to operate with the Motorola-approved antenna types with the maximum permissible gain and required antenna impedance for

each antenna type indicated. Antenna types not included, having a gain greater than the maximum gain indicated for that type, are strictly prohibited for use with this device.

Software Version

All the features described in the following sections are supported by the radio's software version **R11.00.00** or later.

Check with your dealer or system administrator for more details of all the features supported.

Notice to Users (FCC and Industry Canada)

This device complies with Part 15 of the FCC rules and RSS 210 of the Industry Canada rules per the conditions listed below:

- 1 This device may not cause harmful interference.
- 2 This device must accept any interference received, including interference that may cause undesired operation.
- 3 Changes or modifications made to this device, not expressly approved by Motorola, could void the user's authority to operate this equipment.

Informations importantes sur la sécurité

Exposition aux radiofréquences et sécurité du produit pour radios bidirectionnelles portatives

ATTENTION!

Cette radio ne doit être utilisée qu'à des fins professionnelles. Avant d'utiliser la radio, lisez le guide Exposition aux radiofréquences et sécurité du produit pour radios bidirectionnelles portatives, qui contient d'importantes instructions de fonctionnement pour une utilisation sécuritaire et des informations sur l'exposition aux fréquences radioélectriques afin d'assurer la conformité aux normes et règlements applicables.

Pour obtenir une liste d'antennes et d'autres accessoires approuvés par Motorola, consultez le site Web:
<http://www.motorolasolutions.com/APX>

Selon la réglementation d'Industrie Canada, cet émetteur radio ne peut être utilisé qu'avec une antenne dont le type et le gain maximal (ou minimal) sont approuvés par Industrie Canada pour cet émetteur. Afin de limiter les interférences radio pour les

autres utilisateurs, le type et le gain de l'antenne doivent être choisis de façon à ce que la puissance isotrope rayonnée

équivalente (P.I.R.E.) ne soit pas plus forte qu'il ne le faut pour établir la communication.

Le présent émetteur a été approuvé par Industrie Canada pour fonctionner avec les types d'antenne agréés par Motorola et ayant un gain admissible maximal ainsi que l'impédance requise pour chaque type d'antenne indiqué. Les types d'antenne non inclus, dont le gain est supérieur au gain maximal indiqué, sont strictement interdits pour l'exploitation de l'émetteur.

Version du logiciel

Toutes les fonctionnalités décrites dans les sections suivantes sont prises en charge par la version du logiciel **R11.00.00** ou ultérieure de la radio.

Vérifiez auprès de votre détaillant ou de l'administrateur de système pour obtenir des renseignements sur les fonctionnalités prises en charge.

Avis aux utilisateurs (FCC et Industrie Canada)

Cet appareil est conforme à la Partie 15 des règlements de la FCC et RSS 210 du règlement d'Industrie Canada selon les conditions énumérées ci-dessous:

- 1 Ce dispositif ne doit pas causer d'interférences nuisibles.
- 2 Cet appareil doit accepter toute interférence reçue, y compris les interférences qui peuvent perturber le fonctionnement.
- 3 Les changements ou les modifications apportées à ce dispositif, non expressément approuvées par Motorola, peuvent annuler le droit de l'utilisateur à utiliser cet équipement.

Computer Software Copyrights

The Motorola products described in this manual may include copyrighted Motorola computer programs stored in semiconductor memories or other media. Laws in the United States and other countries preserve for Motorola certain exclusive rights for copyrighted computer programs, including, but not limited to, the exclusive right to copy or reproduce in any form the copyrighted computer program. Accordingly, any copyrighted Motorola computer programs contained in the Motorola products described in this manual may not be copied, reproduced, modified, reverse-engineered, or distributed in any manner without the express written permission of Motorola. Furthermore, the purchase of Motorola products shall not be deemed to grant either directly or by implication, estoppel, or otherwise, any license under the copyrights, patents or patent applications of Motorola, except for the normal non-exclusive license to use that arises by operation of law in the sale of a product.

Documentation Copyrights

No duplication or distribution of this document or any portion thereof shall take place without the express written permission of Motorola. No part of this manual may be reproduced, distributed, or transmitted in any form or by any means, electronic or mechanical, for any purpose without the express written permission of Motorola.

Disclaimer

The information in this document is carefully examined, and is believed to be entirely reliable. However, no responsibility is assumed for inaccuracies. Furthermore, Motorola reserves the right to make changes to any products herein to improve readability, function, or design. Motorola does not assume any liability arising out of the applications or use of any product or circuit described herein; nor does it cover any license under its patent rights, nor the rights of others.

Getting Started

Take a moment to review the following:

How to Use This Guide	page 1
Notations Used in This Manual	page 1
Additional Performance Enhancement	page 2
What Your Dealer/System Administrator Can Tell You	page 2

How to Use This Guide

This User Guide covers the basic operation of the APX™ 3000 Portables.

However, your dealer or system administrator may have customized your radio for your specific needs. Check with your dealer or system administrator for more information.

Notations Used in This Manual

Throughout the text in this publication, you will notice the use of **WARNING**, **Caution**, and **Note**. These notations are used to emphasize that safety hazards exist, and the care that must be taken or observed.



An operational procedure, practice, or condition, etc., which may result in injury or death if not carefully observed.



An operational procedure, practice, or condition, etc., which may result in damage to the equipment if not carefully observed.

Note:

An operational procedure, practice, or condition, etc., which is essential to emphasize.

■ Additional Performance Enhancement

The following are some of the latest creations designed to enhance the security, quality and efficiency of your radios.

CrossTalk Prevention

This feature prevents crosstalk scenario from happening, especially when a wideband antenna is used. This feature allows the adjustment of the Trident Transmitting SSI clock rate in your radio to be varied from the Receiving Frequency. This subsequently reduced the possibilities of radio frequency interfering spurs and prevents the issues of crosstalk.

SecureNet

SecureNet allows you to perform secured communications on an Analog or Motorola Data Communication (MDC) channel. The MDC OTAR feature will allow you to perform OTAR activities on an MDC channel.

■ What Your Dealer/System Administrator Can Tell You

Check with your dealer or system administrator for the correct radio settings, if your radio is to be operated in extreme temperatures (less than -30 °C or more than +60 °C), to ensure proper operation.

You can also consult your dealer or system administrator about the following:

- Is your radio preprogrammed with any preset conventional channels?
- Which buttons have been preprogrammed to access other features?
- What optional accessories may suit your needs?

Preparing Your Radio for Use

APX 3000 is a small body radio meant to work together with other light weight accessories such as Mission Critical Wireless Remote Control Unit (RCU), headset and pod in order to interact with you efficiently.

IMPORTANT!

- 1 Your radio has a Voice Announcement feature (programmable) which provides **audible status** updates of your radio function through the **speaker microphone, earpiece or headset**. This helps to confirm the changes you have made when interacting with your radio in covert. See **Voice Announcement†** on **page 67** to learn how this feature works.
- 2 You must connect a **GCAI Display Remote Speaker Microphone (DRSM)** to see the radio status displayed in words or icons. Most of these radio statuses are mentioned in the content across this manual.

Throughout the text in this publication, notice the use of the symbols shown below. They are to remind you that an external accessory is required to see or hear the indications of your radio during an operation procedure, practice, or condition etc., which:

- † Requires to connect a **speaker microphone, earpiece or headset** to your radio to hear the audio tones or announcements.
- ‡ Requires to connect a **DRSM** to your radio to read the strings or indications displayed on your radio.

The application of these accessories are optional. Consult your agent for the most suitable features and accessories required for you to work with this radio.

Assemble your radio by following these steps:

Charging the Battery	page 4
Battery Charger	page 4
Attaching the Battery†	page 5
Installing the Antenna	page 6
Attaching the Accessory Connector Cover	page 6
Installing Accessories with GCAI Connector	page 7
Turning On Your Radio‡	page 7
Adjusting the Volume†	page 8
Pairing Radio with Pod and Earpiece†‡	page 9
Pairing Radio with Mission Critical Remote Control Unit (RCU)	page 10
Using the Carry Holster	page 10
Inserting to the Carry Holster	page 10
Removing Your Radio from the Carry Holster	page 11
Tying Your Radio and Flexible Antenna to Your Body	page 12
Positioning Your Radio and Devices on Your Body	page 12
Installing the Flexible Antenna	page 13

Charging the Battery



WARNING

To avoid a possible explosion:

- **DO NOT** replace the battery in any area labeled “hazardous atmosphere”.
- **DO NOT** discard batteries in a fire.

The Motorola-approved battery shipped with your radio is uncharged. Prior to using a new battery, charge it for a minimum of 16 hours to ensure optimum capacity and performance.

For a list of Motorola-authorized batteries available for use with your radio, see **Accessories** on page 73.

Note: When charging a battery attached to your radio, turn your radio off to ensure a full charge.

Battery Charger

To charge the battery, place the battery, with or without your radio, in a Motorola-approved charger. The charger’s LED indicates the charging progress; see your charger’s user guide.

For a list of chargers, see **Accessories** on page 73.

■ Attaching the Battery‡

With your radio turned off, slide the battery into your radio's frame until the bottom latch clicks into place.

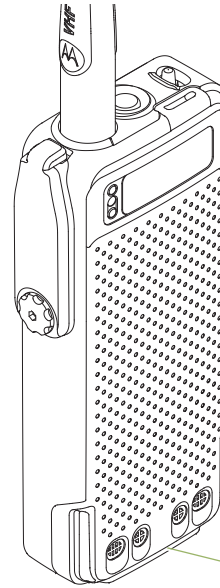
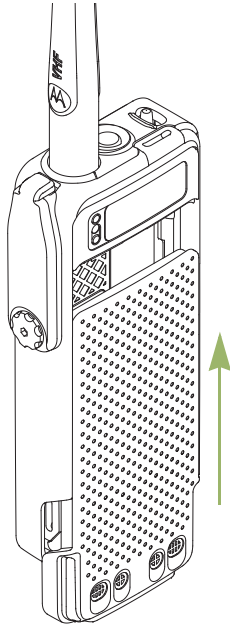

Battery Latch is at the bottom of the battery.

To remove the battery, turn your radio off. Lift up the latch then slide the battery down to remove the battery from your radio.

Note: If your radio is preprogrammed with volatile-key retention, the encryption keys are retained for approximately 30 seconds after battery removal. Check with your dealer or system administrator for more information.

You can view the status of the IMPRES™ battery if your radio is using an IMPRES™ battery. See **Checking the Battery Charge Status** on page 71 for more information.

■ Installing the Antenna

With your radio turned off, set the antenna in its receptacle and turn clockwise to attach it to your radio.

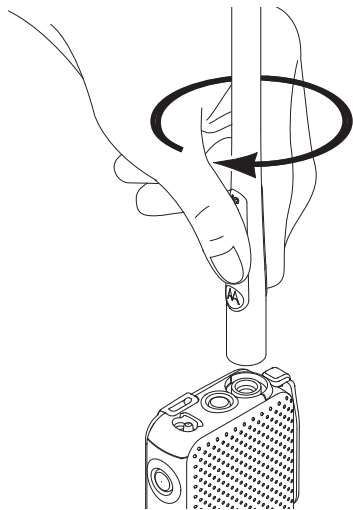

To remove the antenna, turn the antenna counterclockwise. Make sure you turn off your radio first.

Note: For Flexible Antenna, see **Tying Your Radio and Flexible Antenna to Your Body** on page 12 for proper steps to strap it to your body.

■ Attaching the Accessory Connector Cover

The accessory connector is located on the antenna side of your radio. It is used to connect accessories to your radio.

Note: To prevent damage to the connector, shield it with the connector cover when not in use.

Insert the hooked end of the cover into the slot above the connector. Press downward on the cover's top to seat it in the slot. Once in place, rotate the thumbscrew clockwise by hand until tight.

To remove the accessory connector cover, rotate the thumbscrew counterclockwise until it disengages from your radio. If the thumbscrew is too tight, use an Allen wrench to loosen it first.

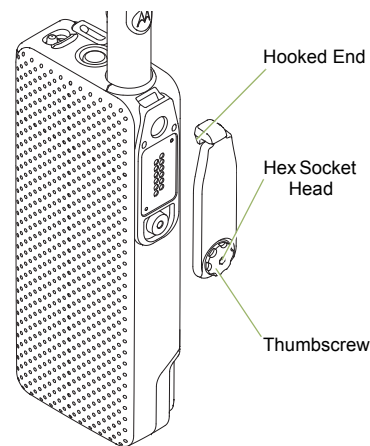

Rotate and lift the connector cover to disengage it from your radio.

■ Installing Accessories with GCAI Connector

Connect a GCAI DRSM to see the icons and strings and hear audio alerts and transmission of your radio. You can also hear the audio alerts with a GCAI Surveillance Earpieces.

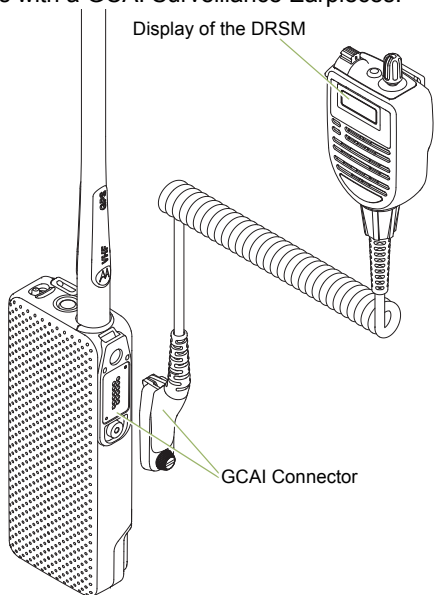

■ Turning On Your Radio

Push the On/Off Switch to turn the power on or off. You see a green spot when the switch is in the ON position.

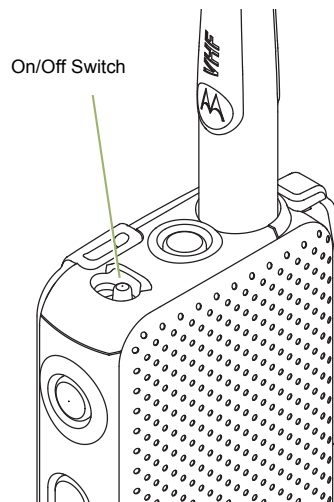

If the power-up test is successful, you see momentary **MOTOROLA** on the DRSM.

Note: If the power-up test is unsuccessful, you see **ER XX/YY** (**XX/YY** is an alphanumeric code) on your DRSM screen. Turn off your radio, check the battery, and turn on your radio.

If your radio fails the power-up test again, record the **ER XX/YY** code and contact your dealer.

*To turn off your radio, push the **On/Off Switch** until you do not see the green spot.*

■ Adjusting the Volume†

By default, press the Up and Down Arrow Button to adjust the volume you hear on your headset.

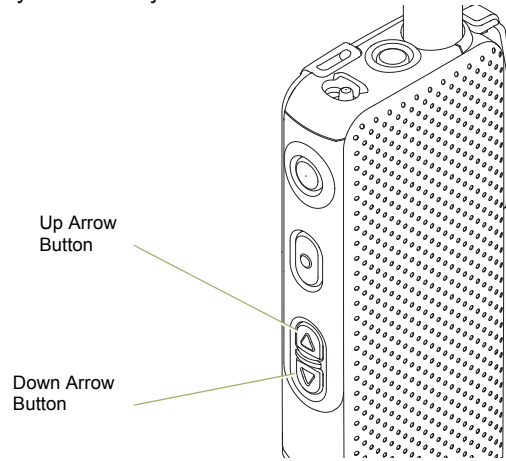

Please refer to your agent or qualified radio technician if you need to enable the Up and Down Arrow Button with other function.

Note: When using DSRM or headset, ensure that the main speaker is pointed towards you for increased loudness and intelligibility, especially in areas with loud background noises.

Ensure the Up and Down Arrow Button is in Volume mode by pressing the Multi Function Button (MFB) to toggle to Volume mode.

MFB must be preprogrammed to a programmable button.

■ Pairing Radio with Pod and Earpiece†‡

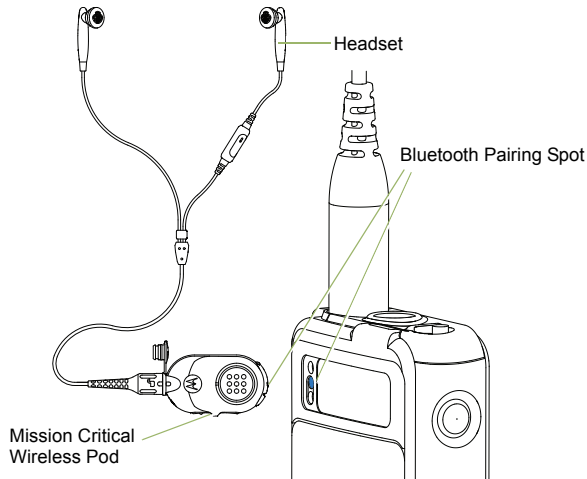

Plug the earpiece to the wireless Pod.

Verify that both your radio and pod are powered ON and in pairing mode. Place the Bluetooth pairing spot on your Pod within one inch of the Bluetooth pairing spot on your radio.

Your radio Blue LED lights up solid for 2 seconds once connected and followed by blinking blue at heartbeat pace to indicate there is Bluetooth device connected to your radio.

Note: Ensure the microphone is not covered when you speak into the microphone.

Your Pod can function as a standalone PTT device without the earpiece.

■ Pairing Radio with Mission Critical Remote Control Unit (RCU)

Verify that both your radio and RCU are powered ON and in pairing mode.

On your RCU, press and hold the Trunk button while powering up your RCU to enter pairing mode.

Place the Bluetooth pairing spot of your RCU within one inch of the Bluetooth pairing spot of your radio.

Your radio Blue LED lights up solid for 2 seconds once connected and followed by blinking blue at heartbeat pace to indicate there the Bluetooth device is connected to your radio.

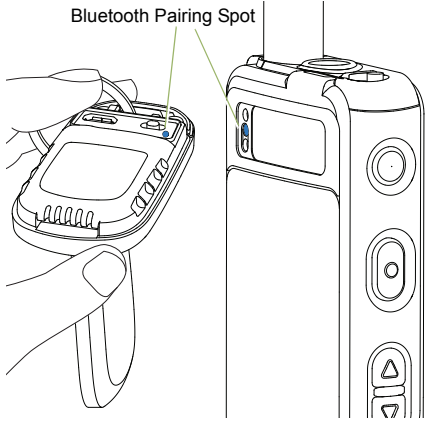

■ Using the Carry Holster

📄 Inserting to the Carry Holster

Position your radio within the carry holster with the LEDs facing inward. Slide your radio down into the carry holster.

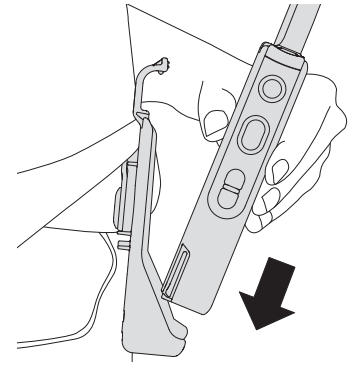

Push your radio to the carry holster until it clicks in place.

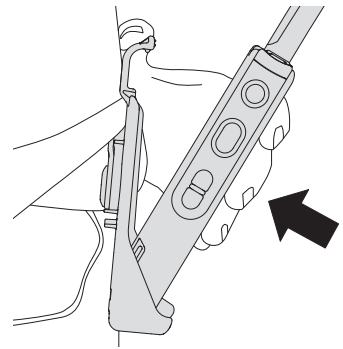

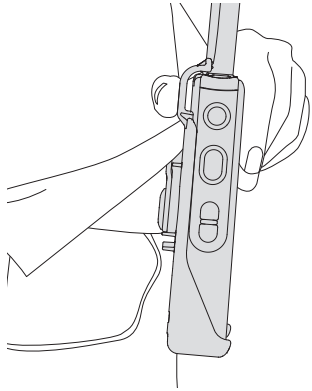

Your radio is successfully secured to the carry holster.

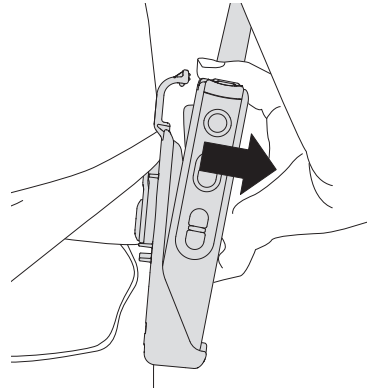

Pull your radio out from the carry holster.

Removing Your Radio from the Carry Holster

Push the hook of the carry holster to release your radio top.

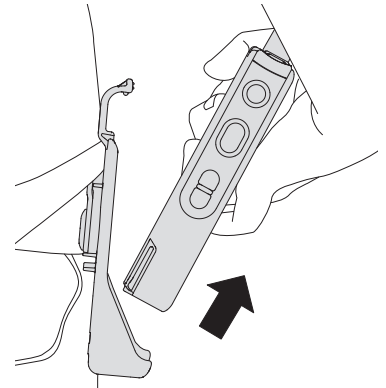
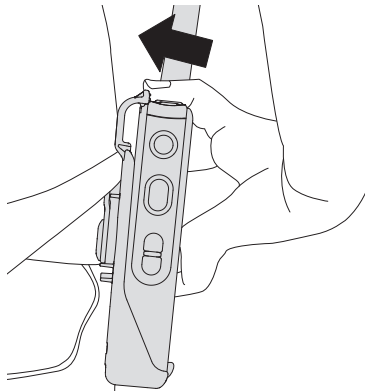

■ Tying Your Radio and Flexible Antenna to Your Body

Note: When using this antenna, use only Motorola-approved batteries, wired surveillance and wireless audio accessories. Using approved wired surveillance and wireless audio accessories is important because the use of non-Motorola approved accessories may result in exposure levels, which exceed the occupational/controlled environment RF exposure limits.

📄 Positioning Your Radio and Devices on Your Body

APX 3000 radio is designed to be operated while concealed under your outer garments. See the following pictures for the recommended position to place your radio.

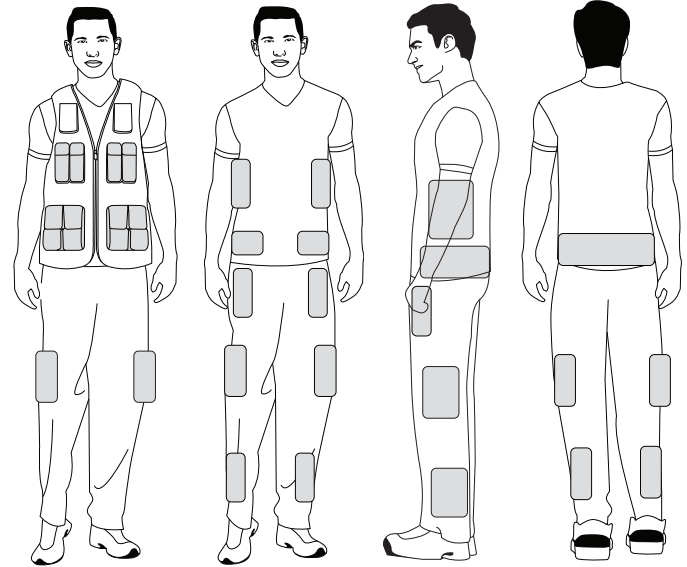

Note: Securely tape or strap **only** the battery side of the radio to your body.

Installing the Flexible Antenna

With your radio turned off, set the antenna in its receptacle and turn clockwise to attach it to your radio.

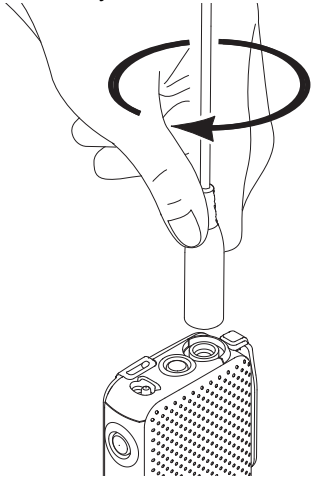

Note: The tightening torque allowable is 15 lb-ft (maximum) to avoid damage to the antenna and radio.

*To remove the antenna, turn the antenna counterclockwise.
Make sure you turn off your radio first.*



Caution

- Do not twist or coil the antenna because this will result in antenna performance degradation. See pictures below.



Not recommended



Acceptable



Caution

- To satisfy compliance with RF Exposure standards and improve radio performance, use the spacers provided to maintain a distance of 0.50 inch (1.27 cm) from your body. See the detail picture below.

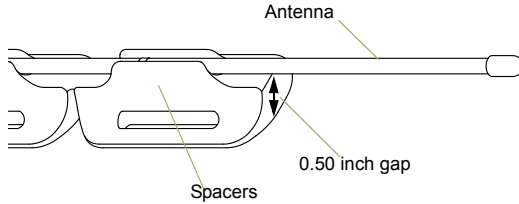

Caution

- To improve radio performance, secure the antenna as shown in picture below. Ensure the spacer is upright when strapping it to the body.

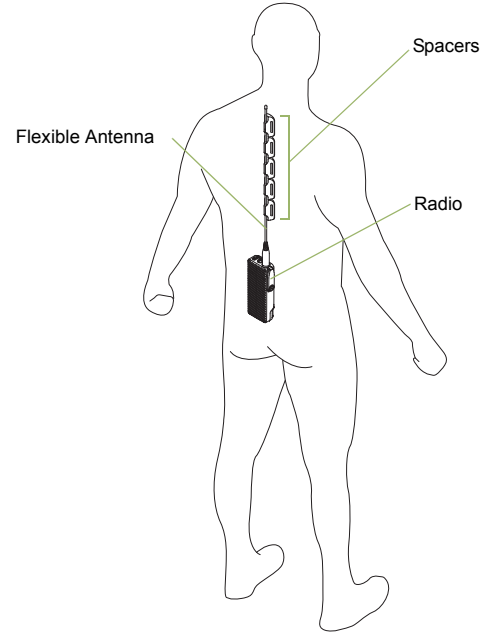

Strapping the Antenna onto Your Body

Procedure:

- 1 Position the spacers along the antenna to maintain 0.5 inch (1.27cm) from your body.

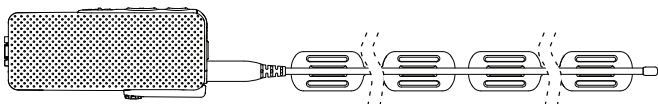

- 2 The spacer can be cut into individual segment per method shown below.

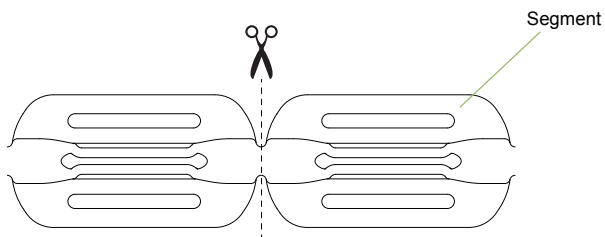

The table below shows number of spacer segments for different antenna bands.

Antenna Frequency Band	Number of spacers provided*	Number of spacer segments
700 / 800 MHz	1	5
UHF	3	12
VHF	2	7

*One spacer comes with five segments.

- 3 Use surgical tape or straps to fasten the spacer to the body with the methods below.

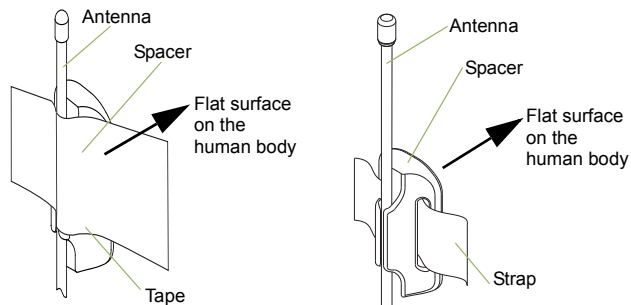

Identifying Radio Controls

Take a moment to review the following:

Radio Parts and Controls	page 17
Programmable Features	page 18
Assignable Radio Functions	page 18
Assignable Settings or Utility Functions	page 19
Accessing the Preprogrammed Functions	page 19
Multi-Functional Button (MFB).	page 19
Using Push-To-Talk (PTT) Button†	page 20

Radio Parts and Controls

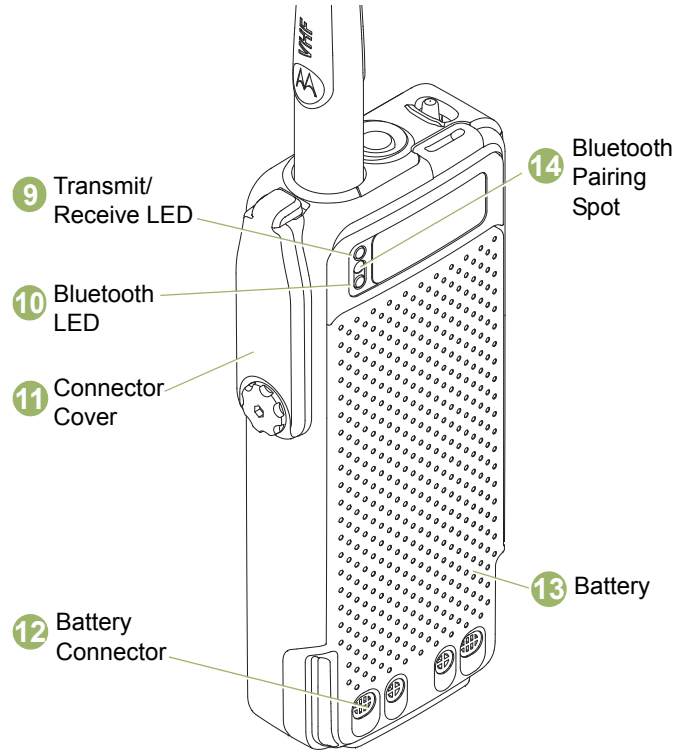
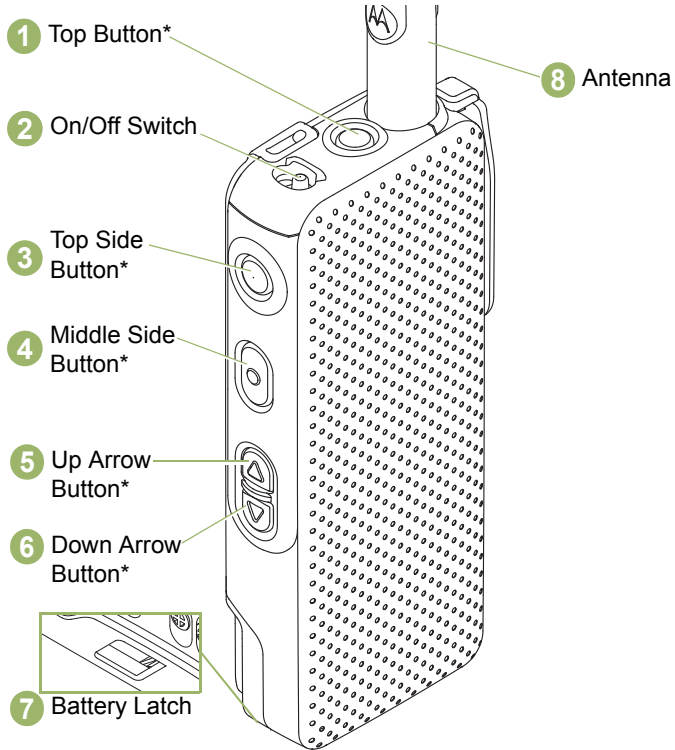

* These radio controls/buttons are programmable.

■ Programmable Features

Any reference in this manual to controls that are “preprogrammed” means that a qualified radio technician must use your radio’s programming software to assign a feature to a control.

Your dealer can program the programmable buttons as shortcuts to radio functions or preset channels/groups depending on the duration of a button press:

- Press – Pressing and releasing rapidly.
- Long press – Pressing and holding for the preprogrammed duration (between 0.25 seconds and 3.75 seconds).
- Hold down – Keeping the button pressed.

Assignable Radio Functions

Bluetooth On/Off – Allows you to turn on/off the Bluetooth.

Bluetooth Audio Reroute – Allows you to toggle the audio route from your radio to Remote Speaker Microphone or Bluetooth headset.

Bluetooth Headset PTT – Keys up your Bluetooth Headset’s microphone. For APX3000, this feature can be configured to key up Bluetooth Headset’s microphone, or GCAI’s accessory’s microphone when Bluetooth Headset’s microphone is not available.

Bluetooth Clear All Pairing – Allows you to clear all pairing information for Bluetooth. This is accessed by a long press of the Bluetooth On/Off Button.

Bluetooth Inquiry On/Off – Enables Bluetooth Search feature.

Bluetooth Discoverable On/Off – Enables Bluetooth visibility. This is accessed by a long press of the Bluetooth Inquiry On/Off Button.

Call Response – Allows you to answer a private call.

Channel Up and Down – Toggles the channel up and down.

Emergency – Depending on the programming, initiates or cancels an emergency alarm or call.

Internet Protocol – Displays the Internet Protocol (IP) address, device name and status of your radio.

Man Down Clear – Clears the alarm of Man Down mode which was triggered when your radio achieves or passes a tilt angle threshold or a combination of the angle threshold and a motion sensitivity level.

Mode Change – Toggles to selected channel or zone preprogrammed to your radio.

Mode Select – Long-press programs a button with your radio’s current zone and channels; then once programmed, the short press of that button jumps your radio to the programmed zone and channel.

Monitor (Conventional Only) – Monitors a selected channel for all radio traffic until function is disabled.

Nuisance Delete – Temporarily removes an unwanted channel, except for priority channels or the designated transmit channel, from the scan list.

One Touch 1 – Launches a specific feature with one single button-press.

Rekey Request – Notifies the dispatcher you require a new encryption key.

Reprogram Request (Trunking Only) – Notifies the dispatcher you want a new dynamic regrouping assignment.

Scan – Toggles scan on or off.

Secure Transmission Select (Conventional and Trunking) – Toggles the Secure Transmission On or Off when the Secure/Clear Strapping fields is set to “Select” for your radio’s current channel, and when your radio is model/option capable.

Talkaround/Direct (Conventional Only) – Toggles between using a repeater and communicating directly with another radio.

Tx Inhibit – Inhibits transmission.

User – Automatically registers with the server.

Volume Up and Down – Toggles volume level up and down.

Zone Up and Down – Toggles zone up and down.

Assignable Settings or Utility Functions

Light/Flip – Press the button to toggle the display backlight on or off.

Controls Lock – Locks or unlocks the programmable buttons.

Voice Announcement – Audibly indicates the current feature mode, Zone or Channel you has just assigned.

Voice Mute – Toggles voice mute on or off.

■ Accessing the Preprogrammed Functions

You can access various radio functions through a short or long press of the relevant programmable buttons.

Multi-Functional Button (MFB)

This button control enables you to select the features which the Up and Down Arrow Button can adjust. All the programmable buttons can be preprogrammed as MFB.

The features available for MFB are:

Volume Change – To enable the Up or Down Arrow Button to change the volume of your speaker or headset. Press the Up or Down Arrow Button to increase or decrease the volume level of your headset. Long press the Arrow Button makes coarse tuning of the volume level; short press the Arrow Button makes fine tuning of the volume level.

Mode Change – To enable the Up or Down Arrow Button to change the channel or zone. Press the Up or Down Arrow Button to toggle the channel or zone up or down.

Your radio by default is set to use the primary feature. Short presses of MFB toggle to either the secondary or primary feature.

The secondary feature has an inactivity timer. This timer starts when the secondary feature is left idle. Your radio returns to primary feature when this timer expires.

Consult your dealer or system administrator for the best option available for MFB.

■ Using Push-To-Talk (PTT) Button†

The **PTT** button can be preprogrammed on your radio's or RCU's programmable button. The programmable PTT feature and the PTT button on the Pod serves two basic purposes:

- While a call is in progress, the **PTT** button allows your radio to transmit to other radios in the call.

Press and hold down **PTT** button to talk. Release the **PTT** button to listen.

The microphone is activated when the **PTT** button is pressed.

- While a call is not in progress, the **PTT** button is used to make a new call. See **Monitoring Features††** on page 35 for more information.

Identifying Status Indicators

Your radio indicates its operational status through the following:

Status Icons‡ page 21
 LED Indicator. page 23
 LED Indicators in Surveillance Mode†. page 24
 Intelligent Lighting Indicators‡. page 25
 Alert Tones† page 26

■ Status Icons‡

The 112 x 32 pixel monochrome display screen of your DRSM shows your radio status and operating conditions.



Battery

For IMPRES™ battery operation only – the icon shown indicates the charge remaining in the battery.

For all battery operation – the icon blinks when the battery is low.



Received Signal Strength Indicator (RSSI)

The number of bars displayed represents the received signal strength for the current site, for trunking only. The more stripes in the icon, the stronger the signal.



Roaming

The radio has roamed to and is currently registered to a foreign system.



Direct

- **On** = Radio is currently configured for direct radio to radio communication (during conventional operation only).
- **Off** = Radio is connected with other radios through a repeater.



Monitor (Carrier Squelch)

Selected channel is being monitored (during conventional operation only).



Power Level

- **L** = Radio is set at Low power.
- **H** = Radio is set at High power.



Scan

Radio is scanning.



Priority Channel Scan

- **Blinking dot** = Radio detects activity on channel designated as Priority-One.
- **Steady dot** = Radio detects activity on channel designated as Priority-Two.



Vote Scan Enabled

The vote scan feature is enabled.



Secure Operation

- **On** = Secure operation.
- **Off** = Clear operation.
- **Blinking** = Receiving an encrypted voice call.



Bluetooth On

Bluetooth is on and ready for Bluetooth connection.



Bluetooth Connected

Bluetooth is currently connected to the external bluetooth device.

LED Indicator

The LED indicator shows the operational status of your radio.

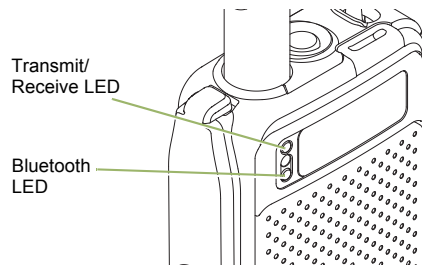

Transmit/Receive LED	Bluetooth LED	Status
Solid red	–	Radio is transmitting.
Solid red	Solid green	Radio is upgrading the firmware.
Blinking red	–	Radio is powering up with fatal error.
Slow blinking red	–	Radio is transmitting at low battery condition.
Blinking red	Blinking blue	Radio is powering up with update in progress.
Rapid blinking red	–	Radio has failed the self test upon powering up or encountered a fatal error.
Solid yellow	–	Channel is busy (Conventional only).
Rapid blinking yellow	–	Radio is receiving a secured transmission.
Solid green	–	Radio is powering up.
		Radio is locked.
Solid green for three seconds	–	Radio power up is successful.

Transmit/Receive LED	Bluetooth LED	Status
Solid green	Short blinking blue with long interval	Radio is reading or upgrading by CPS.
-	Blinking blue three times	Bluetooth is powering on or off.
-	Slow Blinking blue	Radio is waiting to be paired when no device is connected with radio in Bluetooth.
-	Blinking blue at heartbeat pace	Radio is connected with at least a device in Bluetooth link.
-	Solid blue for two seconds	Bluetooth device is connected.
		Bluetooth device is disconnected.
-	Blinking blue	Radio is clearing Bluetooth pairing information.
-	Rapid blinking blue for two seconds	Radio fails to connect or disconnect from a device.
-	Solid blue	Radio is powering up with Option Board error.

Note: No LED indication occurs when your radio receives a clear (non-secured) transmission in trunking Mode.

LED Indicators in Surveillance Mode†

For covert operation, the LED can be preprogrammed to be turned off at specific zone or channel. During operation in these zone or channel the LED blinking is not seen, instead Voice Announcement can be used to hear and confirm the operation status.

Hence, It is recommended to duplicate the channel programming into a separate zone and have the associated Voice Announcement tied to zone to help indicate the LED on/off state, for example "Light Off" "Zone 1". Using zone control in this case eases going into and out of the zone or channel preprogrammed with the LED on/off setting.

■ Intelligent Lighting Indicators†

This feature temporarily changes the backlight of the DRSM display screen to indicate a radio event has occurred.

Note: This feature must be preprogrammed by a qualified radio technician.

Backlight	Notification	When
Orange	Emergency Alerts	Your radio initiates an emergency alarm or call.
		Your radio receives an emergency alarm or call.
Red	Critical Alerts	Your radio battery is low.
		Your radio is out of range.
		Your radio enters failsoft mode.
		Your radio is unable to establish a full connection with the system.
		Your radio is unable to authenticate or register with the system.
Green	Call Alerts	Your radio receives a private call.
		Your radio receives a phone call.
		Your radio receives a call alert.
		Your radio receives a selective call.

■ Alert Tones†

An alert tone is a sound or group of sounds. Your radio uses alert tones to inform you of your radio's condition. The following table lists these tones and when they occur. You can hear them using the Mission Critical Wireless Bluetooth headset or GCAI DRSM.

You Hear	Tone Name	Heard
Short, Low-Pitched Tone	Radio Self Test Fail	When radio fails its power-up self test.
	Reject	When an unauthorized request is made.
	Time-Out Timer Warning	Four seconds before time out.
	No ACK Received	When radio fails to receive an acknowledgment.
	Man Down Entry	When radio initiates Man Down mode.
Long, Low-Pitched Tone	Time-Out Timer Timed Out	After time out.
	Talk Prohibit/ PTT Inhibit	When PTT button is pressed, transmissions are not allowed.
	Out of Range	When PTT button is pressed, radio is out of range of the system.
	Invalid Mode	When radio is on an unpreprogrammed channel.
A Group of Low-Pitched Tones	Busy	When the system is busy.

You Hear	Tone Name	Heard
Short, Medium-Pitched Tone	Valid Key-Press	When a valid key is pressed.
	Radio Self Test Pass	When radio passes its power-up self test.
	Clear Voice	At beginning of a non-coded communication.
	Priority Channel Received	When activity on a priority channel is received.
	Emergency Alarm/Call Entry	When entering the emergency state.
	Central Echo	When central controller has received a request from a radio.
Long, Medium-Pitched Tone	Volume Set	When volume is changed on a quiet channel.
	Emergency Exit	When exiting the emergency state.
A Group of Medium-Pitched Tones	Failsoft	When the trunking system fails.
	Automatic Call Back	When voice channel is available from previous request.
	Keyfail	When encryption key has been lost.
	Console Acknowledge	When emergency alarm, or reprogram request ACK is received.
	Received Individual Call	When Call Alert or Private Call is received.
	Site Trunking	When a SmartZone trunking system fails.

You Hear	Tone Name	Heard
Short, High-Pitched Tone (Chirp)	Low-Battery Chirp	When battery is below preset threshold value.
Ringling	Phone Call Received	When a land-to-mobile phone call is received.
Gurgle	Dynamic Regrouping	(When PTT button is pressed) a dynamic ID has been received.
	Talk Permit	(When PTT button is pressed) is verifying with the system for accepting its transmissions.
Incremental-Pitched Tone	Bluetooth Paired	When Bluetooth accessory is paired with your radio.
	Bluetooth Connected	When Bluetooth accessory is connected to your radio.
Decremental-Pitched Tone	Bluetooth Unpaired	When Bluetooth accessory is unpaired from your radio.
	Bluetooth Disconnected	When Bluetooth accessory is disconnected from your radio.
A Group of Very High-Pitched Tones	Man Down Continuous Tone	When radio is in Man Down mode and prepares to transmit Emergency Alarm when the timer of this alarm ends.
	Critical Man Down Continuous Tone	When radio is in Man Down Enhanced mode and prepares to transmit Emergency Alarm when the timer of this alarm ends.
Doh-Sol	MFB Enters Secondary Feature	When MFK is toggled to secondary feature.
Sol-Doh	MFB Exits Secondary Feature	When MFK is toggled to exit secondary feature and return to primary feature, or when secondary function timer expires.

General Radio Operation

Once you understand how your APX Portable is configured, you are ready to use your radio.

Use this navigation guide to familiarize yourself with the basic Call features:

Selecting a Zone†	page 29
Selecting a Radio Channel†	page 30
Using Mode Select Feature	page 31
Saving a Zone and Channel to a Mode Select Button†	page 31
Receiving and Responding to a Radio Call	page 32
Receiving and Responding to a Call‡	page 32
Receiving and Responding to a Private Call (Trunking Only)†‡	page 33
Receiving and Responding to a Telephone Call (Trunking Only)†‡	page 33
Making a Radio Call†	page 34
Repeater or Direct Operation	page 34
Monitoring Features†‡	page 35
Monitoring a Channel	page 35
Conventional Mode Operation	page 35

Selecting a Zone†

A zone is a group of channels.

Use the following procedure to select a zone.

Note: Your radio must be preprogrammed to allow you to use this feature.

Procedure:

- 1 If **Selecting a Zone** is the secondary function of the Up and Down Arrow Buttons, short press the MFB to toggle to Selecting a Zone mode. You hear the Secondary Mode tone and associated Voice Announcement if configured.
OR
If Zone Up or Down feature is pre-programmed on a programmable button, skip to step 2.
OR
If **Selecting a Zone** is the primary function of Up and Down Arrow Buttons, skip to step 2.
- 2 Press the Up and Down Arrow Buttons, or the preprogrammed Zone Up or Zone Down buttons to toggle the zone list backward or forward. If configured, you can hear Voice Announcement of the selected zone.
- 3 Press the **PTT** button to transmit on the selected zone channel.

See **Voice Announcement†** on **page 67** to understand how the Voice Announcement works.

■ Selecting a Radio Channel†

A channel is a group of radio characteristics, such as transmit/receive frequency pairs.

Use the following procedure to select a channel.

Note: The radio must be preprogrammed to allow you to use this feature. If you select a channel that is not within the preprogrammed band, your radio indicates that it is on an unsupported frequency with an audio warning.

Procedure:

1 If **Selecting a Channel** is the secondary function of the Up and Down Arrow Buttons, short press the MFB to toggle to selecting channel mode. You hear the Secondary Mode Tone and associated Voice Announcement if configured.

OR

If Channel Up or Down feature is pre-programmed on a programmable button, skip to step 2.

OR

If **Selecting a Channel** is the primary function of Up and Down Arrow Buttons, skip to step 2.

2 Press the Up and Down Arrow Buttons or pre-programmed Channel up or down button to toggle the channel list backward or forward. If configured, you hear Voice Announcement of the selected channel.

3 Press the **PTT** button to transmit on the selected channel.

See **Voice Announcement†** on page 67 to understand how the Voice Announcement works.

■ Using Mode Select Feature

Mode Select allows a long press to save your radio's current zone and channel to a programmable button. Once it saved, a short-press of the button jumps the transmission to the saved zone and channel.

To save the selected zone and channel, press the preprogrammed button.

Note: Your radio must be preprogrammed to allow you to use this feature.

Saving a Zone and Channel to a Mode Select Button†

This feature allows to save two different zones or channels to a preprogrammed button.

Procedure:

- 1 Toggle your zone and channel to the required zone and channel.

- 2 Press the preprogrammed button to save the zone or channel.

- 3 You hear a short, medium-pitched tone when the zone and channel is saved.

Note: To change the programmed zone and channel, repeat this procedure.

■ Receiving and Responding to a Radio Call

Once you have selected the required channel and/or zone, you can proceed to receive and respond to calls.

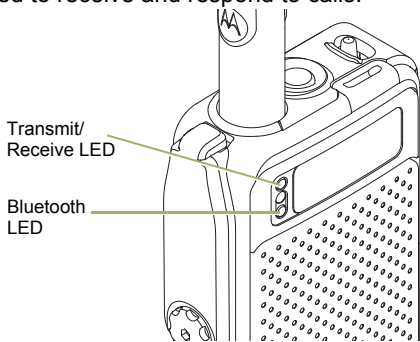

The **Transmitting or Receiving LED** lights up solid red when your radio is transmitting. In conventional mode, this LED lights up solid yellow when your radio is receiving a transmission. In trunking mode, there is no LED indication when your radio receives a transmission.

If your radio is receiving a secure transmission, this LED blinks yellow.

📄 Receiving and Responding to a Call†

Procedure:

When you receive a call, depending on how your radio is preprogrammed:

1 **ASTRO Conventional Only:**

The LED lights up solid yellow.

OR

Trunking Only:

The display shows the caller alias or ID.

- 2 Press the **PTT** button to respond to the call. The LED lights up solid red.
- 3 Release the **PTT** button to listen.

See **Making a Radio Call†** on page 34 for details on making a Talkgroup Call.

Receiving and Responding to a Private Call (Trunking Only)††

A Private Call is a call from an individual radio to another individual radio.

These one-to-one calls between two radios are not heard by others in the current talkgroup. The calling radio automatically verifies that the receiving radio is active on the system and can display the caller's ID.

Note: Your radio automatically exits the feature, if the feature inactivity timer is enabled and when your radio is left idle and the timer expires. You hear the Inactive Exit Tone upon feature exit.

Procedure:

When you receive a Private Call:

- 1 You hear two alert tones and the LED blinks green. The backlight of the screen turns green and the display shows **CALL RCV**, alternating with the caller alias (name) or ID (number).
- 2 Press the **Call Response** button within 20 seconds after the call indicators begin.
- 3 Press and hold the **PTT** button to talk. Release the **PTT** button to listen.
- 4 Press the **Call Response** button to hang up.

You cannot initiate a Private Call.

Receiving and Responding to a Telephone Call (Trunking Only)††

This feature allows you to receive calls similar to standard phone calls from a landline phone.

Note: Your radio automatically exits the feature, if the feature inactivity timer is enabled and when your radio is left idle and the timer expires. You will hear the Inactive Exit Tone upon feature exit.

Procedure:

When you receive a Telephone Call:

- 1 You hear a telephone-type ringing and the LED blinks green. The backlight of the screen turns green and the display shows **PHN CALL**.
- 2 Press the **Call Response** button within 20 seconds after the call indicators begin.
- 3 Press and hold the **PTT** button to talk. Release the **PTT** button to listen.
- 4 Press the **Call Response** button to hang up.

You cannot initiate a Telephone Call.

■ Making a Radio Call†

Procedure:

- 1 Select a zone or channel by:
Press the preprogrammed Zone or Channel Up Down Button.
OR
Press the Up or Down Arrow Button via toggling the MFB.
 - 2 You hear Voice Announcement of the selected zone or channel if it is enabled.
-

■ Repeater or Direct Operation

The **REPEATER** operation increases your radio's range by connecting with other radios through a repeater. The transmit and receive frequencies are different.

The **DIRECT** or "talkaround operation" allows your radio to bypass the repeater and connect directly to another radio. The transmit and receive frequencies are the same.

Procedure:

Press the preprogrammed **Repeater/Direct** button to toggle between talkaround and repeater modes.

■ Monitoring Features††

Radio users who switch from analog to digital radios often assume that the lack of static on a digital channel is an indication that your radio is not working properly. This is not the case. Digital technology quiets the transmission by removing the “noise” from the signal and allowing only the clear voice or data information to be heard.

Use the Monitor feature to make sure a channel is clear before transmitting.

📄 Monitoring a Channel

Procedure:

- 1 Press the preprogrammed **Monitor** button to toggle Monitoring on.
- 2 Press and hold the **PTT** button to transmit. The LED lights up solid red.
- 3 Release the **PTT** button to receive (listen).

*The Carrier Squelch indicator appears on the display when you monitor a channel via the preprogrammed **Monitor** button.*

📄 Conventional Mode Operation

Your radio may be preprogrammed to receive Private-Line® (PL) calls.

Procedure:

- 1 Momentarily press the **Monitor** button to listen for activity. The Carrier Squelch indicator appears on the display.
- 2 Press and hold the **Monitor** button to set continuous monitor operation. The duration of the button press is programmable.
- 3 Press the **Monitor** button again, or the **PTT** button, to return to the original squelch setting.

*If you try to transmit on a receive-only channel, you hear an invalid tone until you release the **PTT** button.*

Advanced Features

Use this navigation guide to learn more about advanced features available with your radio:

Advanced Call Features	page 36
Scan	page 38
Call Alert Paging††	page 40
Emergency Operation††	page 40
Man Down††	page 44
Secure Operations	page 48
Trunking System Controls††	page 52
Mission Critical Wireless - Bluetooth® -††	page 54
Programming Over Project 25 (POP 25) (ASTRO 25 and ASTRO Conventional)	page 61
Voice Announcement†	page 62
Using Site Selectable Alerts (ASTRO 25)††	page 63
Utilities	page 63

Advanced Call Features

Receiving and Responding to a Selective Call (Conventional Only)††

This feature allows you to receive a call from or to call a specific individual. It is intended to provide privacy and to eliminate the annoyance of having to listen to conversations that are of no interest to you.

Procedure:

- 1 When you receive a Selective Call, you hear two alert tones and the LED lights up solid yellow. The backlight of the screen turns green momentarily and the display briefly shows **CALL RCV**.
- 2 The speaker unmutes.
- 3 Press and hold the **PTT** button to talk. Release the **PTT** button to listen.

You cannot initiate a Selective Call.

Using the Dynamic Regrouping Feature (Trunking Only)††

This feature allows the dispatcher to temporarily reassign selected radios to a particular channel where they can communicate with each other. This feature is typically used during special operations and is enabled by a qualified radio technician.

You will not notice whether your radio has this feature enabled until a dynamic regrouping command is sent by your dispatcher.

Note: If you try to access a zone or channel that has been reserved by your dispatcher as a dynamically regrouped mode for other users, an invalid tone sounds.

Procedure:

- 1 When your radio is dynamically regrouped, it automatically switches to the dynamically regrouped channel. A “gurgle” tone sounds and the display shows the dynamically regrouped channel’s name.
- 2 Press the **PTT** button to talk. Release **PTT** button to listen.

When your dispatcher cancels dynamic regrouping, your radio automatically returns to the zone and channel that you were using before your radio was dynamically regrouped.

Requesting a Reprogram (Trunking Only)††

This feature allows you to notify your dispatcher when you want a new dynamic regrouping assignment.

Procedure:

- 1 Press the preprogrammed **Reprogram Request** button to send reprogram request to your dispatcher.
- 2 The display alternates between **RPGM** and **PLS WAIT**.
- 3 If you hear five beeps, your dispatcher has acknowledged the reprogram request. The display shows **ACK RCVD**.
OR
If your dispatcher does not acknowledge the reprogram request within six seconds, a low-pitched alert tone sounds and the display shows **NO ACK**.

Classifying Regrouped Radios

Your dispatcher can classify regrouped radios into either of two categories: **Select Enabled** or **Select Disabled**.

- Select-enabled radios are free to change to any available channel, including the dynamic-regrouping channel, once you have selected the dynamic-regrouping position.
- Select-disabled radios cannot change channels while dynamically regrouped. Your dispatcher has forced your radio to remain on the dynamic-regrouping channel.

The Scan or Private Call feature cannot be selected while your radio is Select Disabled.

Scan

This feature allows you to monitor traffic on different channels by scanning a preprogrammed list of channels.

Turning Scan On or Off

Procedure:

- 1 Press the preprogrammed Scan button to toggle Scan on or off.
-
- 2 The display shows **SCAN ON** and the scan icon, indicating that scan is enabled.
OR
The display shows **SCAN OFF**, indicating that scan is disabled.
-

Deleting a Nuisance Channel†

If a channel continually generates unwanted calls or noise (termed a “nuisance” channel), you can temporarily remove the unwanted channel from the scan list.

This capability does not apply to priority channels or the designated transmit channel.

Note: Deleting a “nuisance” channel is **only** possible through the preprogrammed **Nuisance Channel Delete** button.

Procedure:

1 Press and hold the preprogrammed **Scan** button to delete the nuisance channel.

OR

When your radio is locked onto the channel to be deleted, press the preprogrammed **Nuisance Delete** button.

2 Your radio continues scanning the remaining channels in the list.

Restoring a Nuisance Channel

Procedure:

To restore the deleted nuisance channel, do **one** of the following:

- Turn your radio off and then turning it on again.

OR

- Stop and restart a scan via the preprogrammed **Scan** button.

OR

- Mode change to another channel and back to the original channel.

■ Call Alert Paging†‡

This feature allows your radio to work like a pager.

Note: This feature must be preprogrammed by a qualified radio technician.

Receiving a Call Alert Page

Procedure:

- 1 When you receive a Call Alert page, you hear four repeating alert tones and the LED blinks green.
- 2 The backlight of the screen turns green and the display briefly shows **PAGE RCV**.

You cannot send a Call Alert page.

■ Emergency Operation†‡

The Emergency feature is used to indicate a critical situation.

If the **Top** button is preprogrammed to send an emergency signal, this signal overrides any other communication over the selected channel.

Your radio supports the following Emergency modes:

- Emergency Alarm
- Emergency Call (Trunking Only)
- Emergency Alarm with Emergency Call
- Silent Emergency Alarm

Check with your dealer or system administrator for more information on the programming of this feature.

Only **one** of the Emergency modes above can be assigned to the preprogrammed **Emergency** button.

Note: To exit emergency at any time, press and hold the preprogrammed **Emergency** button until your radio exit emergency. The timer of this long press can be preprogrammed. Consult the qualified technician to program the duration required.

Note: The radio operates in the normal dispatch manner while in Emergency Call, except if enabled, it returns to one of the following:

- **Tactical/Non-Revert** – The radio sends emergency alarm and/or make emergency call on the current selected channel.
- **Non-Tactical/Revert for Conventional system** – The radio reverts to the preprogrammed emergency channel to send alarm and/or make emergency call.
- **Non-Tactical/Revert for Trunking system** – The radio reverts to the preprogrammed emergency talkgroup to send alarm and/or make emergency call.

Man Down is an alternate way to activate the Emergency feature on the condition the Emergency must be set up for this feature to operate.

See **Man Down†** on page 44 for details.

Sending an Emergency Alarm

This feature lets you send a data transmission, which identifies the radio sending the emergency, to your dispatcher.

Note: Emergency button press timer by default is set to 1 second. This timer is programmable from 0 – 6 seconds by a qualified technician.

Procedure:

- 1 Press and hold the preprogrammed **Emergency** button.
- 2 The display shows **EMERGENCY** and the current zone or channel. A short, medium-pitched tone sounds and the LED blinks red momentarily.
OR
An invalid tone sounds, if the selected channel does not support emergency.
- 3 When you receive your dispatcher's acknowledgment, the display shows **ACK RCVD**. Four tones sound, the alarm ends, and your radio exits the Emergency Alarm mode.
OR
If no acknowledgement is received, the display shows **NO ACK**. The alarm ends and your radio exits the Emergency Alarm mode.

Sending an Emergency Call (Trunking Only)

This feature gives your radio priority access to a talkgroup.

Procedure:

- 1 Press the preprogrammed **Emergency** button.
- 2 The display shows **EMERGENCY** and the current zone or channel. A short, medium-pitched tone sounds.
OR
An invalid tone sounds, if the selected channel does not support emergency.
- 3 Press and hold the **PTT** button. Speak clearly with your microphone near your mouth.
- 4 Release the **PTT** button to end the transmission and wait for a response from your dispatcher.
- 5 Press and hold the preprogrammed **Emergency** button until your radio exits the Emergency Call mode.

Note: The timer of this long press can be preprogrammed. Consult your qualified technician to program the duration required.

Sending an Emergency Alarm with Emergency Call

This feature gives your radio priority access on a channel for conventional system, and to a talkgroup for trunking system.

Procedure:

- 1 Press the preprogrammed **Emergency** button.
- 2 The display shows **EMERGENCY** and the current zone or channel. A short, medium-pitched tone sounds and the LED blinks red momentarily.
OR
An invalid tone sounds, if the selected channel does not support emergency.
- 3 Your radio enters the Emergency Call state when: You receive your dispatcher's acknowledgment. The display shows **ACK RCVD**.
OR
You receive no acknowledgement. The display shows **NO ACK**.
OR
You press the **PTT** button while in the Emergency Alarm mode.
- 4 Press and hold the **PTT** button. Speak clearly with the microphone near your mouth.
- 5 Release the **PTT** button to end the transmission and wait for a response from your dispatcher.

- 6 Press and hold the preprogrammed **Emergency** button until your radio exits the Emergency Call mode.

Note: The timer of this long press can be preprogrammed. Consult the qualified technician to program the duration required.

Sending a Silent Emergency Alarm

This feature allows you to send an Emergency Alarm to the system without triggering any audio or visual indicators.

Procedure:

- 1 Press the preprogrammed **Emergency** button.
- 2 The display shows no changes, the LED does not light up, and you hear no tones.
- 3 The silent emergency state continues until you:
Press and hold the preprogrammed **Emergency** button for about a second to exit the Silent Emergency Alarm mode.
OR
Press and release the **PTT** button to exit the Silent Emergency Alarm mode and enter regular dispatch or Emergency Call mode.

Changing Channels during Emergency

For **ALL** Emergency signals, when changing channels:

- If the new channel is also preprogrammed for Emergency, you can change channels while in Emergency operation. The emergency alarm or call continues on the new channel.
- If the new channel is **NOT** preprogrammed for Emergency, the display shows **NO EMERG**. You hear an invalid tone until you exit the Emergency state or change to a channel preprogrammed for Emergency.

Using the Emergency Keep-Alive Feature

This feature, when enabled, prevents your radio from being turned off via the On/Off Switch when your radio is in the Emergency state.

Note: Your radio only exits the Emergency state using one of the ways mentioned in the previous sections.

See ***Sending an Emergency Alarm*** on page 41, ***Sending an Emergency Call (Trunking Only)*** on page 42, ***Sending an Emergency Alarm with Emergency Call*** on page 42, or ***Sending a Silent Emergency Alarm*** on page 43.

■ Man Down††

Man Down condition is determined based upon your radio tilt angle or a combination of radio tilt angle and the lack of radio motion.

Man Down feature is an alternate way to activate the Emergency feature if Emergency has been programmed in your radio.

Note: This feature could be preprogrammed for all channels that support Emergency feature or could be preprogrammed specifically to a zone and channel which has Emergency feature. Consult your agent or qualified technician for more details.

Your radio automatically activates Emergency Alarm or Call when your radio achieves or passes a tilt angle threshold or a combination of the angle threshold and your radio motion is below the motion sensitivity level, depending upon how your radio is programmed. Your radio must stay in this condition for a preprogrammed amount of time before the Emergency Alarm or Call is activated.

Note: It is recommended that an Emergency button is preprogrammed in order to allow you to exit the emergency condition.

The Man Down feature provides a **Clear** function to you. After a Man Down condition has been detected, you can press a preprogrammed **Clear** button to cancel the Man Down

condition. Your radio remains in the Man Down state without triggering an emergency condition until your radio is moved out of the Man Down state, at which point Man Down functionality resumes.

The Man Down feature has three phases:

- i Your radio senses the Man Down condition and **Pre-Alert Timer** is initiated.
- ii Man Down condition continues for the time duration defined in the **Pre-Alert Timer** field. At the end of this time, your radio alerts you on the Man Down status with an audible alert tone and **Man Down** text on the screen. The Post-Alert Timer also initiates at this point.
- iii Man Down condition continues for the time duration defined in the **Post-Alert Timer** field. Once the timer expires, the Emergency alarm is transmitted. The Man Down Clear function is used in this phase to cancel the Man Down condition.

The following scenarios affect the timers:

- Pressing the PTT button suspends the Man Down timers; releasing the PTT button reinitiates the Pre-Alert Timer.
- Pressing other buttons on your radio does not impact these timers.
- Repositioning your radio exits the Man Down feature, which stops and resets the timers.

- Pressing a preprogrammed **Clear** button stops and resets the timers. The timers do not restart until your radio is repositioned.

Note: Emergency must be set up for this feature to operate. For details on operating the Emergency alerts, please see **Emergency Operation††** on page 40.

If your radio is preprogrammed to **horizontal** only, it must be worn in a **vertical** position otherwise the Man Down alert may be inadvertently triggered.

When your radio is programmed with Man Down feature, special care is required when charging your radio with a **wall mounted charger**. See **Handling Your Radio** on page 70 for details.

Pre-Alert Timer

This timer sets the amount of time that a Man Down condition must be present before you are warned of the Man Down condition.

When your radio detects that it has returned to the vertical position or when your radio detects motion, the Pre-Alert timer stops and is reset.

The Pre-Alert timer reinitiates when your radio detects it is in the horizontal position or motionless again.

Post-Alert Timer

This timer sets the amount of time your radio needs to remain in the Man Down condition before the Emergency alarm is transmitted. When the Post-Alert Timer is initiated, your radio alerts you with an audible tone and displays the “**MAN-DOWN**” text.

See **Exiting Man Down Feature** on page 47 to exit Man Down feature.

Alerting Tones When Man Down Feature is Triggered

The Man Down alert tone volume is directly related to your radio’s volume. Ensure that your radio’s volume is loud enough so that you do not miss the Post-Alert tone.

Note: If your radio is programmed with Silent Emergency, your radio inhibits the alert tone and visual alert associated with the emergency feature.

Note: If your radio is programmed in Surveillance Mode, your radio inhibits all tones and lights on your radio including the Man Down tones.

Triggering Emergency

When you have not clear the Man Down condition and the Post-Alert Timer comes to an end, Emergency Alarm or call is triggered. Your radio sends emergency message to units within the same Talkgroup. Your radio also sends ID number and GPS coordinates to your dispatcher if these features are enabled.

See **Emergency Operation†** on page 40 for details regarding exiting Emergency mode.

Note: At this point the Man Down features is complete. Use normal Emergency procedures to cancel Emergency transmissions.

Alerting User When Man Down Enhanced is Triggered

Note: This feature is to be preprogrammed specifically to a zone and channel which supports Emergency feature.

The volume and repetition duration of Man Down Enhanced alert tone could be customized and preprogrammed to suite the required situation.

Consult your agent or qualified technician for more details.

When the radio initiates Man Down Enhanced, you hear the **Critical Man Down Continuous** alert tone from the radio speaker. The volume of this tone is preprogrammed to a

minimum level or to the current radio speaker level. Whichever louder is applied. This can act as a beacon to find the radio.

Note: If the radio is programmed with Silent Emergency, the radio inhibits the alert tone and visual alert associated with the emergency feature.

If the radio is programmed in Surveillance Mode, the alert tone can be heard from the radio speaker.

Once the alert tone is active, changing to another channel with different setup triggers different response from the radio.

- **To a channel without Emergency feature** – The alert tone is inhibited.
- **To a channel with Emergency but no Man Down feature** – The alert tone is inhibited.
- **To a channel with Emergency and different Man Down configuration** – The current alert tone is inhibited and replaced with a different alert tone.
- **To a channel with Emergency and similar Man Down configuration** – The alert tone continues.

Exiting Man Down Feature

If you are not in a real Man Down situation, you should exit the Man Down feature and prevent emergency from going off with the following operation.

Procedure:

Repositioning your radio or shaking your radio (when motion sensitivity is enabled).

OR

Press the preprogrammed **Man Down Clear** button to exit.

Re-Initiating Man Down

After exiting the Emergency Operation when your radio is still in Man Down condition (tilted achieving threshold angle or motionless), reinitiate the Man Down feature by exiting the Man Down condition.

Procedure:

Return your radio to the vertical position

OR

Shake your radio (when motion sensitivity is enabled).

Testing the Man Down Feature

Note: Enable the Emergency feature with Silent Alarm disabled, but not in Surveillance Mode before running this test on your radio.

Procedure:

When Man Down is enabled on your radio:

- 1 Turn your radio on and place in the vertical position, for at least 5 seconds.

- 2 Lay your radio down in the horizontal position.

- 3 Wait for alert tone.

- 4 Your radio alerts with audible tone and displays **MAN-DOWN**.

OR

If no tone is heard, make sure that the Man Down feature is enabled on your radio. If Man Down feature was not enabled, please enable it and go through steps 1,2 and 3 again.

OR

If the Man Down feature is enabled and no tone is heard, send your radio to a qualified technician.

Handling Man Down Functional Error Messages

Procedure:

- 1 If your radio display shows one of the following error messages: **HW BOARD ABSENT**, **MAND HW ERROR** or **HW BRD MISMATCH**. Send your radio to the qualified technician to fix this error.

■ Secure Operations

Secure radio operation provides the highest commercially available level of voice security on both trunked and conventional channels.

Unlike other forms of security, Motorola digital encryption provides signaling that makes it virtually impossible for others to decode any part of an encrypted message.

📄 Selecting Secure Transmissions†‡

Procedure:

Press the preprogrammed **Secure/Clear** button to toggle to clear mode.

Note: If the selected channel is preprogrammed for clear-only operation – when you press the **PTT** button, an invalid mode tone sounds and the display shows **CLR TX**.

Your radio cannot transmit until you toggle the **Secure/Clear** button to the clear mode.

📄 Selecting Clear Transmissions†‡

Procedure:

Press the preprogrammed **Secure/Clear** button to the clear secure mode.

Note: If the selected channel is preprogrammed for secure-only operation – when you press the **PTT** button, an invalid mode tone sounds and the display shows **SEC TX**.

Your radio cannot transmit until you toggle the **Secure/Clear** button to the secure mode.

The radio can be configured to ignore the clear voice or insecured transmission when the radio is in secured transmission. Check with your agent for details.

Managing Encryption

Loading an Encryption Key†

Note: Refer to the key-variable loader (KVL) manual for equipment connections and setup.

Procedure:

- 1 Attach the KVL to your radio.
- 2 All other radio functions are locked out, except for power down, backlight, and volume.
- 3 Select the required keys and press the **Menu Select** button directly below **LOAD** on the KVL. This loads the encryption keys into your radio.
- 4 When the key has been loaded successfully, your radio sounds a short tone for single-key radios.
OR
When the key has been loaded successfully, your radio sounds an alternating tone for multikey radios.
- 5 The KVL prompts that keyload is successful.

Using the Multikey Feature

This feature allows your radio to be equipped with different encryption keys and supports the DES-OFB algorithm.

There are two types:

- **Conventional Multikey** – The encryption keys can be tied (strapped), on a one-per-channel basis, through Customer Programming Software. If talkgroups are enabled in conventional, then the encryption keys are strapped to the talkgroups.
- **Trunked Multikey** – If the radio is used for both conventional and trunked applications, strap the encryption keys for trunking on a per-talkgroup or announcement-group basis. In addition, a different key may be strapped to other features, such as dynamic regrouping, failsoft, or emergency talkgroup.

Erasing All the Selected Encryption Keys‡

This feature allows you to erase all or selected encryption keys.

Procedure:

Use the preprogrammed **Top Side** button and **Top** button to erase the single key in radios with the single-key option, and to erase all keys in radios with the multikey option.

- 1 Press and hold the **Top Side** button.
- 2 While holding **Top Side** button down, press the **Top (Emergency)** button.
- 3 The display shows **PLS WAIT**.
- 4 When all the encryption keys have been erased, the display shows **ALL ERASED**.

Note: **DO NOT** press the **Top/Emergency** button before pressing the **Top Side** button, unless you are in an emergency situation as this sends an emergency alarm.

Requesting an Over-the-Air Rekey (ASTRO Only)‡‡

This feature, also known as **OTAR**, allows your dispatcher to reprogram the encryption keys in your radio remotely. Your dispatcher performs the rekey operation upon receiving a rekey request from you.

Procedure:

- 1 Press and hold the preprogrammed **Rekey Request** button to send the rekey request.
- 2 If the rekey operation fails, a bad-key tone sounds and the display shows **RKY FAIL**.

Note: The rekey operation failure indicates that your radio does not contain the Unique Shadow Key (USK). This key must be loaded into your radio with the key-variable loader (KVL) before the rekey request can be sent.

Refer to your local key management supervisor for more information.

MDC Over-the-Air Rekeying (OTAR) Page

This feature allows to view or define MDC Over-the-Air Rekeying (OTAR) features. It is applied only when operating in secure encrypted mode and only for conventional communications. In addition to Rekey Requests, OTAR transmissions include Delayed Acknowledgements, and Power-up Acknowledgements.

Some of the options selected may also need to be set up at the Key Management Controller (KMC) site to work properly.

Note: This feature must be preprogrammed by a qualified radio technician. Check with your dealer or system administrator for more information.

Infinite UKEK Retention

This feature enables Unique Key Encryption Key (UKEK) to be permanently stored in your radio even when all of the encryption keys is erased. Without this UKEK key, your radio could not be over the air rekeyed.

Note: This feature must be preprogrammed by a qualified radio technician. Check with your dealer or system administrator for more information.

Hear Clear†

There are two components of Hear Clear.

1 Companding:

Reduces the channel noise, e.g. OTA transmission, that is predominantly present in UHF2 and 900 MHz channel with the following features.

- **Compressor** – reduces the background noise flow and the speech signal at transmitting radio.
- **Expander** – expands the speech while the noise flow remains the same at receiving radio.

2 Random FM Noise Canceller (Flutter Fighter):

Reduces the unwanted effects of random FM noise pulses caused by channel fading under high Signal-to-Noise (S/N) conditions such as in a moving in a transportation. The fading effects, heard as audio pops and clicks, are cancelled without affecting the desired audio signal.

The Random FM Noise Canceller operates only in receive mode.

Note: This feature must be preprogrammed by a qualified radio technician. Check with your dealer or system administrator for more information.

Using Radio Kill†‡

This feature allows you to render your radio or another radio inoperable if the radio is misplaced or lost. When a radio is killed, the DRSM display turns blank and all functions of the radio are not usable.

The killed radio can only be recovered from KILL with a special device. Consult an authorised and qualified technician for details.

Using Direct Kill

Direct Kill allows you to make your own radio inoperable.

Procedure:

- 1 Press and hold Top Side Button then press the Orange button until the display turns blank and becomes inoperable.

■ Trunking System Controls†‡

Using the Failsoft System

The failsoft system ensures continuous radio communications during a trunked system failure. If a trunking system fails completely, your radio goes into failsoft operation and automatically switches to its failsoft channel.

Procedure:

- 1 During failsoft operation, your radio transmits and receives in conventional operation on a predetermined frequency.
- 2 A medium-pitched tone sounds every 10 seconds and the display shows **FAILSOFT**.

When the trunking system returns to normal operation, your radio automatically leaves failsoft operation and returns to trunked operation.

Going Out of Range

When your radio goes out of the range of the system, it can no longer lock onto a control channel.

Procedure:

- 1 A low-pitched tone sounds.
AND/OR
The display shows the currently selected zone/channel combination and **OUT RNG**.

 - 2 Your radio remains in this out-of-range condition until:
It locks onto a control channel.
OR
It locks onto a failsoft channel.
OR
It is turned off.
-

Using the Site Trunking Feature

If the zone controller loses communication with any site, that site reverts to site trunking.

You hear a group of medium pitched tone and the display shows the currently selected zone/channel combination and **STE TRNK**.

Note: When this occurs, you can communicate only with other radios within your trunking site.

■ Mission Critical Wireless

- Bluetooth® -†‡

Note: The use of this feature requires the Bluetooth Software.

This feature allows your radio to extend its functionality by connecting to external proprietary Motorola Accessories.

Note: It is recommended to use Motorola proprietary MCW devices with APX radios during Mission Critical operations as other Bluetooth devices may or may not meet the mission critical standard.

The default setting for a Bluetooth-enabled radio is Bluetooth ON. See **Turning the Bluetooth Off** on page 54 to turn the Bluetooth OFF.

Note: Your radio must be preprogrammed by qualified technician to enable this feature.

Currently your radio supports the following Bluetooth devices or profiles.

- Headset (HSP)
- Dial Up Networking (DUN)
- Personal Area Networking (PAN)
- Serial Port (SPP)

📄 Turning the Bluetooth On

Procedure:

- 1 Press the preprogrammed button to turn the Bluetooth on.
- 2 Blue LED blinks three times and a short, medium-pitched tone sounds. The display shows momentary **BT ON**, and †‡ appears to indicate Bluetooth is on.

OR

Blue LED blinks three times and lights up solid blue. The display shows **BT ON FL** to indicate Bluetooth has failed to launch.

*The Bluetooth can be preprogrammed to always **ON** if you need to use Bluetooth most of the time. Check with the qualified technician if this is suitable with your needs.*

📄 Turning the Bluetooth Off

Procedure:

- 1 Press the preprogrammed button to turn the Bluetooth off.
 - 2 The Blue LED blinks three times, a short, medium-pitched tone sounds. The display shows momentary **BT OFF**, and †‡ disappears.
-

Re-Pair Timer

There are two options for configuring your radio's Bluetooth pairing type. The type defines the duration your radio and the accessory retain the pairing information.

- **Immediate** – (For MCW accessories only.) When your radio and/or device is turned off after pairing, the keys are lost. Due to this, when your radio and your device are turned back on, they are unable to re-connect. You must re-pair the devices to re-establish a new set of pairing keys. See **Pairing with LF MPP Pairing Feature** on page 56 or **Pairing with Standard Pairing Feature** on page 58.
- **Infinite** – (For all Bluetooth devices.) When your radio and/or device are turned off after pairing, keys are NOT lost. When your radio and the device are turned back on, they can resume the Bluetooth connection without your intervention.

Re-Pair Timer Options	Re-Pair Timer Scenarios
<p>Immediate (For MCW accessories only.)</p>	<ul style="list-style-type: none"> • When your radio is powered OFF, pairing key is lost immediately, and accessory attempts to pair again. If pairing is unsuccessful within the Drop Timer value, the accessory automatically powers OFF. • When the accessory is powered OFF, all keys are lost immediately, and you must re-pair the devices. • When the devices lose Bluetooth connection, the devices will attempt to re-establish Bluetooth Connection within the Drop Timer value.
<p>Infinite (For all Bluetooth devices.)</p>	<ul style="list-style-type: none"> • When your radio is powered OFF, the accessory attempts to re-establish the Bluetooth Connection for a period of time depending upon the Drop Timer value. If the devices fails to reconnect within the period, the accessory then powers OFF.

Bluetooth Drop Timer

The Bluetooth Drop Timer has two different settings and functions, depending upon the selection of the Re-Pair Timer.

Re-Pair Timer Options	Drop Timer Options
Immediate (For MCW accessories only.)	0 – 15 minutes programmable buffer time to re-establish the Bluetooth Connection when the Bluetooth signal is out of range. If either device powers OFF, the pairing keys are immediately cleared from both devices and the devices must re-pair.
Infinite (For all Bluetooth devices.)	This Timer only applies to the accessory. The programmable timer choices are: 0 – 15 minutes, 2 hours, 4 hours or 8 hours. Do note there are exceptions for Operation Critical Wireless (OCW) headset and PTT which are preprogrammed to 8 hours. This is a "stay alive" time that the accessory will remain ON without the device re-connecting before powering off. The radio will remain ON until the user powers the radio OFF. The radio and accessory will remain paired indefinitely. Once the device re-connect, the timer is reset.

The radio could not control the Drop Timer of Personal Area Networking (PAN), Dial-Up Networking (DUN), Commercial Off-

The-Shelf (COTS) and data services. It is depends on the specifications of these external devices.

Check with your dealer or system administrator for more information about these timers.

See **Pairing with LF MPP Pairing Feature** on page 56 or **Pairing with Standard Pairing Feature** on page 58 to establish the Bluetooth connection.

Pairing with LF MPP Pairing Feature

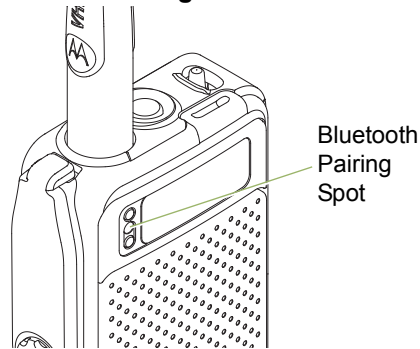

The range of Bluetooth operation is 10 meters line-of-sight communication. This is an **unobstructed** path between the location of the signal transmitter (your radio) and the location of the receiver (your device or accessory).

Obstacles that can cause an obstruction in the line-of-sight include trees, buildings, mountains, cars and etc.

It is **NOT** recommended that you leave your radio behind and expect your accessory to work with a high degree of reliability when they are separated.

At the fringe areas of reception, both voice and tone quality will start to sound "garbled" or "broken". To correct this problem, simply position the Accessory and radio closer to each other (within the 10 meter defined range) to re-establish clear audio reception.

Procedure:

Note: Bluetooth tones and Bluetooth preprogrammed buttons must be preprogrammed by a qualified radio technician. Check with your dealer or system administrator for more information.

To view the Bluetooth LED state, your radio must not be in Surveillance mode during the pairing process.

Once a COTS headset is paired to your radio, it is always connected. Therefore the battery life of the accessory is aligned with the Talk Time power consumption, not the Standby Time consumption.

With your radio's Bluetooth feature ON, and the Bluetooth tones enabled:



- 1 Turn on the accessory, then place it close to your radio aligning the Bluetooth Pairing Spot on your radio to the Bluetooth Pairing Spot (a blue dot) on the accessory.

- 2 If the pairing process is successful your radio sounds an incremental-pitched tone to indicate paired.

OR

If the pairing process fails, your radio sounds a short, low-pitched tone. The display shows **PAIRFAIL**. Repeat step 1 again.

- 3 Your radio continues to connect to the device.

If the connecting process is successful, the blue LED blinks solid blue for two seconds, your radio sounds an incremental-pitched tone. The display shows **<Device Type> CONNCTED**, and the Bluetooth icon turns from  to .

OR

If the device already has pairing records and the connecting process fails, the blue LED blinks rapid blue for two seconds and your radio sounds a short, low-pitched tone. Your radio display shows **<Device Type> CON FAIL**. Repeat step 2 to reconnect the Bluetooth device.

OR

If the connecting process is immediately following the pairing process and the connecting process fails to complete within the 6 seconds, your radio sounds a decremental-pitched tone to indicate unpaired. Your radio display shows **<Device Type> UNPAIRED**. Repeat step 1 to re-initiate the pairing process.



- Note:** If Bluetooth Replace Pairing Info feature is enabled, it allows existing Bluetooth pairing information to be replaced when another accessory of the same type

attempts to pair with your radio. This only occurs when the previously-connected accessory has become disconnected, whether or not the Bluetooth Drop Timer has expired.

Indicating the Bluetooth Connection is Lost

Your radio shows  when the devices have a Bluetooth connection. Below is the scenario and radio indications when the connection is interrupted.

Procedure:

- 1 The blue LED blinks rapid blue for two seconds. The Bluetooth icon starts blinking for 10 seconds. Your radio sounds an decremental-pitched tone and the display shows **<Device Type>** alternates with **CON LOST**.
- 2 If the Bluetooth device successfully re-connects before the Bluetooth Drop Timer expires, Blue LED light solid blue for two seconds. Your radio display shows momentary **<Device Type> CONNCTED**, and  shows persistently.
OR
If the Bluetooth device fails to re-connect within 10 seconds, blue LED blinks rapidly for two second and the blinking  is replaced by a persistent .

Pairing with Standard Pairing Feature

Note: Bluetooth tones and preprogrammed buttons must be preprogrammed by a qualified radio technician. Check with your dealer or system administrator for more information.

Once a COTS headset is paired to your radio, it is always connected. Therefore the battery life of the accessory is aligned with the Talk time power consumption, not the Standby time consumption.

The Bluetooth Standard Pairing feature enables your Bluetooth enabled radio to search for other Bluetooth enabled and discoverable device. Once the device is discovered, your radio automatically pairs with the device.

This feature also enables your Bluetooth enabled radio to be visible to another Bluetooth enabled device and receive request to pair from other device.

Searching and Pairing with the Bluetooth Device

Bluetooth Search in Bluetooth Standard Pairing method is used to scan for other Bluetooth devices nearby. It is set to off by default.

Note: Ensure the Bluetooth on your device is turned to On and is set to **DISCOVERABLE** in order to enable your radio to detect your device in Bluetooth.



The radio only search for HSP devices and Motorola MCW & OCW accessories. Radio will filter out other profiles.

Procedure:

- 1 Press the preprogrammed **Bluetooth Inquiry On/Off** button, to enable the **Bluetooth Search** feature.

- 2 The display shows **SRCH ON**.
OR
If the feature fails to initiate, you hear the radio sounds a short, low-pitched tone. The screen shows **SEARCH FAILED**.

- 3 The display shows **SRCH END** when the radio is pairing with a device found. The display shows **<Device Name> PAIRED** to indicate pairing is complete.
OR
The display shows **SRCH END** when the search timer expires without pairing with any device. Repeat step 1.

- 4 The radio continues to connect to the device. If the connecting process is successful, the radio sounds an incremental-pitched tone. The display shows **<Device Type> CONNCTED**, and the Bluetooth icon turns from  to .

OR

If the device already has pairing records and the connecting process fails, the radio sounds a short, low-pitched tone. The display shows **<Device Type> CON FAIL**. Repeat step 1 to reconnect the Bluetooth device.

OR

If the connecting process is immediately following the pairing process and the connecting process fails to complete within the 6 seconds, the radio sounds a decremental-pitched tone to indicate unpaired. The display shows **<Device Type> UNPAIRED**. Repeat step 1 to re-initiate the pairing process.

Turning Bluetooth Visibility On

Turning Bluetooth visibility to on enables other Bluetooth devices to search for your radio. The visibility of the Bluetooth is set to off by default.

Procedure:

- 1 Press and hold the preprogrammed **Bluetooth Inquiry On/Off** button for three seconds to enable the Bluetooth visibility feature.

- 2** Keep holding the button although you hear a short, medium-pitched tone with the display shows momentary **VISIBLE**.*
OR
If the visibility fails to turn on, the display shows **VISIBLTYFAILED**. Repeat step 1.
OR
When the timer expires, the display shows **VISI OFF**.

**Releasing the preprogrammed button turns off the Visibility mode.*

Receiving Pairing Request from other Devices

Procedure:

With the Visible mode ON, your radio automatically accept the request and pair with any request received from other device.

Turning the Bluetooth Audio On (Routing the Audio from Your Radio to the Headset)

Procedure:

With the external device Bluetooth turned ON.

- 1** Press the preprogrammed button to route the audio from your radio to the headset.
- 2** The blue LED blinks momentarily short blinking blue. Your radio sounds a short, medium-pitched tone. The display shows **HDSET ON**.

Turning the Bluetooth Audio Off (Routing the Audio from the Headset to Your Radio)

Procedure:

With the external device Bluetooth turned ON.

- 1** Press the preprogrammed button to route the audio from the headset to your radio.
- 2** The blue LED blinks momentarily short blinking blue. Your radio sounds a short, medium-pitched tone. The display shows **SPKR ON**.

Adjusting the Volume of Your Radio from Bluetooth Audio Device

Your radio can only control the volume of MCW and OCW Bluetooth enabled audio device. If the radio is paired with other Bluetooth enabled audio device, its volume is independent from the APX radio. In this case, the volume is only adjustable on the device.

Procedure:

With the Bluetooth audio device connected to your radio:

- 1** Adjust volume up/down on the bluetooth audio device.
- 2** Your radio display shows **VOL XX** and sounds a short, medium-pitched tone.

Clearing All Bluetooth Devices Information

- 1 Long press the preprogrammed Bluetooth On/Off button. Your radio sounds a short, medium-pitched tone.
- 2 Your radio display shows **PLS WAIT** and the blue LED blinks blue repeatedly to indicate clearing is in progress.
- 3 Your radio display shows **ALL CLR** to indicate clearing is successful. The blue LED changes to blinking blue with short interval.
OR
Your radio sounds a short, low-pitched tone. The display shows **CLR FAIL** to indicate clearing has failed.

Note: If Re-Pair Timer is set to infinite and you clear keys on your radio, you must clear keys on all previously paired devices as well. (Please see your accessories manual for further details.)

■ Programming Over Project 25 (POP 25) (ASTRO 25 and ASTRO Conventional)

This feature enables configuration data to be upgraded to your radio over-the-air. This feature retains full use of your radio during the configuration data transfer without interrupting communication. The upgrade pauses to give priorities to voice call, and continues after the voice call ended.

Once a configuration upgrade is downloaded to the radio, it is automatically installed during radio power up.

Note: This feature must be preprogrammed by a qualified radio technician. Check with your dealer or system administrator for more information.

■ Voice Announcement†

This feature enables the radio to audibly indicate the current feature mode, zone or channel the user has just assigned. This audio indicator can be customized per customer requirements. This is typically useful when the user is in a difficult condition to read the content shown on the display.

Each voice announcement is within a limit of three seconds maximum. The sum duration of all different voice announcements in a radio shall be no more than 1000 seconds.

Note: This feature must be preprogrammed by a qualified radio technician.

Check with your agent if Voice Announcement is available for the feature you need.

The two options of priority for the Voice Announcement available are:

- **High** – enables the voice of the feature to announce even when the radio is receiving calls.
- **Low** – disables the voice of the feature from announcing when the radio is receiving calls.

Procedure:

You hear a voice announcement when the features below are preprogrammed in the radio.

- The radio powers up. The radio announces the current zone and channel it is transmitting.
- Press the preprogrammed voice announcement button (which specifically programmed to playback the current zone and channel). The radio announces the current zone and channel it is transmitting.

Note: Pressing this preprogrammed playback button will always enable the voice feature to announce in High priority.

All the three programmable buttons at the side of the radio support this feature.

- Change to a new zone. The radio announces the current zone and channel it is transmitting.
- Change to a new channel remaining within the current zone. The radio announces the current channel.
- Press either the **Menu Select** button or preprogrammed button or switch of the radio to launch or terminate Scan, PL Disabled, Talkaround/Direct or Transmit Inhibit. The radio announces the corresponding feature activation or deactivation.

■ Using Site Selectable Alerts (ASTRO 25)†‡

A Site Selectable Alert (SSA) is an Intelligent Lighting indicator together with audio alert sent to radios at a site or a few sites to notify the users when there is a special situation that they need to be aware of. Only authorized radios are enabled to send SSA.

Upon the activation of a SSA, the receiving radios display the alert alias and generate the periodic alert tone.

Note: Alert alias, alert tone, and alert period can be preprogrammed. Alert period is the duration for the radio to repeat the alert tone. An interval of 5 seconds might impact the battery life of the radio. Check with your dealer or system administrator for more details.

When mixing SSA with received voice audio, the SSA alert is reduced in volume to ensure that the voice message is still heard clearly. Therefore, it is important that the SSA audio files are created with clear loud audio to ensure they can still be heard clearly when played at reduced levels.

■ Utilities

📄 Flipping the Display on DRSM†

This feature allows you to reverse the content of your DRSM display upside down.

Procedure:

Press and hold the preprogrammed **Light/Flip** button to flip the strings on the screen upside down.

📄 Controlling the Display Backlight†

You can enable or disable your DRSM's display backlight as needed, if poor light conditions make the display difficult to read.

Procedure:

Press the preprogrammed **Light/Flip** button to toggle the backlight on or off.

OR

Press any programmable radio controls or buttons to turn the backlight on.

Note: The backlight remains on for a preprogrammed time before it automatically turns off completely or returns to the minimum backlight level.

Locking and Unlocking the Controls†‡

You can lock your radio's programmable buttons to avoid inadvertent entry. This function can be preprogrammed as a short press or long press per your request. Refer to your qualified technician for advice.

Procedure:

- 1 Long press the preprogrammed Control Lock button to lock the controls. Associated Voice announcement will be played if preprogrammed.
- 2 The display shows **CTRL LCK**.
- 3 Long press again to unlock the controls. Associated Voice announcement will be played if preprogrammed.

Turning Voice Mute On or Off†‡

You can enable and disable voice transmission, if needed.

Procedure:

- 1 Press the preprogrammed **Voice Mute** button to turn the feature off or on.
- 2 The display shows momentary **VMUT OFF**, and a short tone sounds, indicating that the feature is disabled. You hear associated Voice announcement if preprogrammed.
OR
The display shows momentary **VMUT ON**, and a short tone sounds, indicating that the feature is enabled. You hear associated Voice announcement if preprogrammed.

Using the Time-Out Timer

This feature turns off your radio's transmitter. You cannot transmit longer than the preset timer setting.

If you attempt to do so, your radio automatically stops your transmission, and you hear a talk-prohibit tone.

The timer is defaulted at 60 seconds, but it can be preprogrammed from 3 to 120 seconds, in 15-second intervals, or it can be disabled entirely for each radio mode, by a qualified radio technician.

Note: You will hear a brief, low-pitched, warning tone four seconds before the transmission times out.

Procedure:

- 1 Hold down the **PTT** button longer than the preprogrammed time. You hear a short, low-pitched warning tone, the transmission is cut-off, and the LED goes out until you release the **PTT** button.
- 2 Release the **PTT** button. The timer resets.
- 3 Press the **PTT** button to re-transmit. The time-out timer restarts and the LED lights up solid red.

Using the Conventional Squelch Operation Features

This feature filters out unwanted calls with low signal strength or channels that have a higher than normal background noise.

Analog Options

Tone Private Line (PL), Digital Private-Line (DPL), and carrier squelch can be available (preprogrammed) per channel.

Mode	Result
Carrier squelch (C)	You hear all traffic on a channel.
PL or DPL	Your radio responds only to your messages.

Digital Options

One or more of the following options may be preprogrammed in your radio. Check with your dealer or system administrator for more information.

Option	Result
Digital Carrier-Operated Squelch (COS)	You hear any digital traffic.
Normal Squelch	You hear any digital traffic having the correct network access code.

Option	Result
Selective Switch	You hear any digital traffic having the correct network access code and correct talkgroup.

Using the Digital PTT ID Feature

This feature allows you to see the radio ID (number) of the radio from whom you are currently receiving a transmission. This ID, consisting up to a maximum of eight characters, can be viewed by both the receiving radio and your dispatcher.

Your radio's ID number is also automatically sent every time the PTT button is pressed. This is a per-channel feature. For digital voice transmissions, your radio's ID is sent continuously during the voice message.

Using the Smart PTT Feature (Conventional Only)

Smart PTT is a per-personality, programmable feature used in conventional radio systems to keep your radio from talking over other radio conversations.

When smart PTT is enabled in your radio, you cannot transmit on an active channel.

If you try to transmit on an active smart-PTT channel, you hear an alert tone, and the transmission is inhibited. The LED lights up solid yellow to indicate that the channel is busy.

Three variations of smart PTT are available:

Transmit Inhibit on Busy Channel with Carrier	You cannot transmit if any traffic is detected on the channel.
Transmit Inhibit on Busy Channel with Wrong Squelch Code	You cannot transmit on an active channel with a squelch code or (if secure-equipped) encryption key other than your own. If the PL code is the same as yours, the transmission is not prevented.
Quick-Key Override	This feature can work in conjunction with either of the two above variations. You can override the transmit-inhibit state by quick-keying your radio. In other words, two PTT button presses within the preprogrammed time limit.

Voice Announcement†

This feature enables your radio to audibly indicate the current feature mode, Zone or Channel you have just assigned. This audio indicator can be customized per customer requirements. This is typically useful when you are in a difficult condition to read the content shown on the display.

Each voice announcement is within a limit of three seconds maximum. The sum total duration for all voice announcements in your radio shall be no more than 1000 seconds.

Note: This feature must be preprogrammed by a qualified radio technician.

Check with your agent if Voice Announcement is available for the feature you need.

The two options of priority for the Voice Announcement available are:

- **High** – enables the voice of the feature to announce even when your radio is receiving calls.
- **Low** – disables the voice of the feature from announcing when your radio is receiving calls.

Procedure:

You hear a voice announcement when the features below are preprogrammed in your radio.

- Your radio powers up. Your radio announces the current zone and channel it is transmitting.
- Press the preprogrammed voice announcement button (which specifically programmed to playback the current zone and channel). Your radio announces the current zone and channel it is transmitting.

Note: Pressing this preprogrammed playback button will always enable the voice feature to announce in High priority.

- Change to a new zone. Your radio announces the current zone and channel it is transmitting.
- Change to a new channel remaining within the current zone. Your radio announces the current channel.
- Press the preprogrammed button of your radio to launch or terminate the feature such as Scan, Talkaround/Direct or Transmit Inhibit, etc. Your radio announces the corresponding feature activation.

Helpful Tips

Take a moment to review the following:

Troubleshooting	page 68
Caring for Your Radio	page 69
Cleaning Your Radio	page 70
Handling Your Radio	page 70
Servicing Your Radio	page 71
Taking Care of the Battery††.	page 71
Checking the Battery Charge Status	page 71
Battery Recycling and Disposal.	page 72

Troubleshooting

Scenario	Solution
LED indicator on the radio is not functioning during transmit and receive or any other operation	The radio might be preprogrammed in lights off mode in the current channel. For covert operation, the LEDs can be preprogrammed to turn off with specific zones or channels. It is hence recommended to add key words like Lights off or Lights on to the zone or channel Voice Announcements .
No LED feedback upon turning on your radio via on/off switch	First, check your battery by docking it into the charger. If the battery is good, it might be the reason that the radio was turned off at a preprogrammed zone/channel which the LED lights would not be shown for covert operation. Change to a zone/channel that LED lights are enabled. Meanwhile, ensure you connect an audio accessory to hear the audio alerts or transmission.
Cannot connect with the Bluetooth accessory	Check the accessory battery and ensure the battery is still good. Also check the accessory device is in the pairing mode.

Note: No LED indication occurs when your radio receives a clear (non-secured) transmission in trunking Mode.

Caring for Your Radio



Caution

- The radio casing has a vent port that allows for pressure equalization in the radio. Never poke this vent with any objects, such as needles, tweezers, or screwdrivers. This could create leak paths into the radio and the radio's submergibility will be lost.

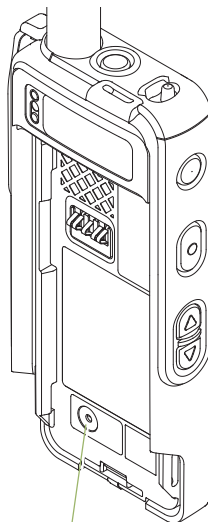

Vent Port



Caution

- The radio is designed to be submerged to a maximum depth of 1 meter, with a maximum submersion time of 30 minutes. Exceeding either maximum limit may result in damage to the radio.
- If the radio battery contact area has been submerged in water, dry and clean the radio battery contacts before attaching a battery to the radio. Otherwise, the water could short-circuit the radio.
- If the radio has been submerged in water, shake the radio well so that any water that may be trapped inside the speaker grille and microphone port can be removed. Otherwise, the water will decrease the audio quality of the radio.
- Do not disassemble the radio. This could damage radio seals and result in leak paths into the radio. Any radio maintenance should be performed only by a qualified radio technician.

Cleaning Your Radio

Procedure:

To clean the external surfaces of your radio:

- 1 Combine one teaspoon of mild dishwashing detergent to one gallon of water (0.5% solution).
- 2 Apply the solution sparingly with a stiff, non-metallic, short-bristled brush, making sure excess detergent does not get entrapped near the connectors, controls or crevices. Dry your radio thoroughly with a soft, lint-free cloth.
- 3 Clean battery contacts with a lint-free cloth to remove dirt or grease.



Do not use solvents to clean your radios as most chemicals may permanently damage your radio housing and texture.

Caution

Do not submerge your radio in the detergent solution.

Handling Your Radio

- Do not pound, drop, or throw your radio unnecessarily. Never carry your radio by the antenna.
- Avoid subjecting your radio to an excess of liquids.
- Do not submerge your radio.
- Avoid subjecting your radio to corrosives, solvents or chemicals.
- Do not disassemble your radio.
- Keep the accessory-connector cover in place until ready to use the connector. Replace the cover immediately once the accessory has been disconnected.
- When charging your radio using a wall mounted charger, your radio must be turned off. Otherwise, the **Man Down Alert and Emergency** may be accidentally triggered.

Servicing Your Radio

Proper repair and maintenance procedures will assure efficient operation and long life for this product. A Motorola maintenance agreement will provide expert service to keep this and all other communication equipment in perfect operating condition. A nationwide service organization is provided by Motorola to support maintenance services. Through its maintenance and installation program, Motorola makes available the finest service to those desiring reliable, continuous communications on a contract basis. For a contract service agreement, please contact your nearest Motorola service or sales representative, or an authorized Motorola dealer.

Express Service Plus (ESP) is an optional extended service coverage plan, which provides for the repair of this product for an additional period of either one or two years beyond the normal expiration date of the standard warranty. For more information about ESP, contact the Motorola Radio Support Center at 3761 South Central Avenue, Rockford, IL 61102 (800) 227-6772 / (847)725-4200.

■ Taking Care of the Battery†‡

Checking the Battery Charge Status

Your radio can indicate the battery's charge status through:

- the LED and sounds.
- the fuel gauge icon on the DRSM display.





LED and Sounds

When your battery is low:

- the LED blinks red when the **PTT** button is pressed.
- you hear a low-battery “chirp” (short, high-pitched tone).

Fuel Gauge Icon

A blinking fuel gauge icon () is displayed only when the battery voltage drops to low level. In this case, replace the battery with a fully charged one.

Gauge	Battery Charge
	76% to 100% full*
	51% to 75%*
	26% to 50%*
	11% to 25%*
	10% or less (at 10%, the gauge begins blinking)

*These are for IMPRES battery operation only.

Battery Recycling and Disposal

In the U.S. and Canada, Motorola participates in the nationwide Rechargeable Battery Recycling Corporation (RBRC) program for battery collection and recycling. Many retailers and dealers participate in this program.

For the location of the drop-off facility closest to you, access RBRC's Internet web site at www.rbrc.com or call 1-800-8-BATTERY. This internet site and telephone number also provide other useful information concerning recycling options for consumers, businesses, and governmental agencies.

Accessories

The accessory link below is for your APX radios. Not all accessories are FCC certified for operation with all APX models and/or bandsplits. Please refer to the specific APX radio price pages for a list of FCC certified accessories or contact your sales representative for accessory compatibility.

<http://www.motorolasolutions.com/APX>

Take a moment to review the following:

Highlights for the Accessories page 73

■ Highlights for the Accessories

- 1 Only the following programming cable is compatible with APX 3000 radios.
 - APX DMR Port Programming Cable (PMKN4012B)
 - Test and Alignment Programming Cable (PMKN4013C)
- 2 FCC ID for the wireless accessories:
 - NTN2574 Wireless Pod: ABZ99FT7007
 - PMLN6233 Discrete Mission Critical Wireless RCU Key FOB: ABZ99FT7014

Appendix: Maritime Radio Use in the VHF Frequency Range

Take a moment to review the following:

Special Channel Assignments	page 74
Operating Frequency Requirements	page 75
Declaration of Compliance for the User of Distress and Safety Frequencies	page 77

■ Special Channel Assignments

Emergency Channel

If you are in imminent and grave danger at sea and require emergency assistance, use **VHF Channel 16** to send a distress call to nearby vessels and the United States Coast Guard.

Transmit the following information, in this order:

- 1 "MAYDAY, MAYDAY, MAYDAY."
- 2 "THIS IS _____, CALL SIGN _____."

State the name of the vessel in distress 3 times, followed by the call sign or other identification of the vessel, stated 3 times.

- 3 Repeat "MAYDAY" and the name of the vessel.
- 4 "WE ARE LOCATED AT _____."

State the position of the vessel in distress, using any information that will help responders to locate you, e.g.:

- latitude and longitude
 - bearing (state whether you are using true or magnetic north)
 - distance to a well-known landmark
 - vessel course, speed or destination
- 5 State the nature of the distress.
 - 6 Specify what kind of assistance you need.
 - 7 State the number of persons on board and the number needing medical attention, if any.
 - 8 Mention any other information that would be helpful to responders, such as type of vessel, vessel length and/or tonnage, hull color, etc.
 - 9 "OVER."
 - 10 Wait for a response.
 - 11 If you do not receive an immediate response, remain by the radio and repeat the transmission at intervals until you receive a response. Be prepared to follow any instructions given to you.

Non-Commercial Call Channel

For non-commercial transmissions, such as fishing reports, rendezvous arrangements, repair scheduling, or berthing information, use VHF Channel 9.

■ Operating Frequency Requirements

A radio designated for shipboard use must comply with Federal Communications Commission Rule Part 80 as follows:

- on ships subject to Part II of Title III of the Communications Act, the radio must be capable of operating on the 156.800 MHz frequency
- on ships subject to the Safety Convention, the radio must be capable of operating:
 - in the simplex mode on the ship station transmitting frequencies specified in the 156.025 – 157.425 MHz frequency band, and
 - in the semiduplex mode on the two frequency channels specified in the table below.

Note: Simplex channels 3, 21, 23, 61, 64, 81, 82, and 83 cannot be lawfully used by the general public in US waters.

Additional information about operating requirements in the Maritime Services can be obtained from the full text of FCC Rule Part 80 and from the US Coast Guard.

Table A-1: VHF Marine Channel List

Channel Number	Frequency (MHz)	
	Transmit	Receive
1	156.050	160.650
2	156.100	160.700

Table A-1: VHF Marine Channel List (Continued)

Channel Number	Frequency (MHz)	
	Transmit	Receive
*	156.150	160.750
4	156.200	160.800
5	156.250	160.850
6	156.300	–
7	156.350	160.950
8	156.400	–
9	156.450	156.450
10	156.500	156.500
11	156.550	156.550
12	156.600	156.600
13**	156.650	156.650
14	156.700	156.700
15**	156.750	156.750
16	156.800	156.800
17**	156.850	156.850
18	156.900	161.500
19	156.950	161.550
20	157.000	161.600
*	157.050	161.650
22	157.100	161.700

Table A-1: VHF Marine Channel List (Continued)

Channel Number	Frequency (MHz)	
	Transmit	Receive
*	157.150	161.750
24	157.200	161.800
25	157.250	161.850
26	157.300	161.900
27	157.350	161.950
28	157.400	162.000
60	156.025	160.625
*	156.075	160.675
62	156.125	160.725
63	156.175	160.775
*	156.225	160.825
65	156.275	160.875
66	156.325	160.925
67**	156.375	156.375
68	156.425	156.425
69	156.475	156.475
71	156.575	156.575
72	156.625	—
73	156.675	156.675
74	156.725	156.725

Table A-1: VHF Marine Channel List (Continued)

Channel Number	Frequency (MHz)	
	Transmit	Receive
75	***	***
76	***	***
77**	156.875	—
78	156.925	161.525
79	156.975	161.575
80	157.025	161.625
*	157.075	161.675
*	157.125	161.725
*	157.175	161.775
84	157.225	161.825
85	157.275	161.875
86	157.325	161.925
87	157.375	161.975
88	157.425	162.025

* Simplex channels 3, 21, 23, 61, 64, 81, 82, and 83 **cannot be lawfully used** by the general public in US waters.

** Low power (1 W) only

*** Guard band

Note: A – in the Receive column indicates that the channel is transmit only.

■ Declaration of Compliance for the User of Distress and Safety Frequencies

The radio equipment does not employ a modulation other than the internationally adopted modulation for maritime use when it operates on the distress and safety frequencies specified in RSS-182 Section 6.1.

Table A-2: Technical Parameters for Interfacing External Data sources

	RS232	USB	SB9600
Input Voltage (Volts Peak-to-peak)	18 V	3.6 V	5 V
Max Data Rate	28 kb/s	12 Mb/s	9.6 kb/s
Impedance	5k Ohm	90 Ohm	120 Ohm

Glossary

This glossary is a list of specialized terms used in this manual.

Term	Definition
ACK	Acknowledgment of communication.
Active Channel	A channel that has traffic on it.
Analog Signal	An RF signal that has a continuous nature rather than a pulsed or discrete nature.
ARS	Automatic Registration Service
ASTRO 25	Motorola standard for wireless digital trunked communications.
ASTRO Conventional	Motorola standard for wireless digital conventional communications.
Autoscan	A feature that allows the radio to automatically scan the members of a scan list.
Bluetooth	Bluetooth is an open wireless technology standard for exchanging data over short distances from fixed and mobile devices with high levels of security.

Term	Definition
Bluetooth Pairing	Bluetooth pairing occurs when two bluetooth devices exchanged a passkey to form a paired Bluetooth wireless connection.
Call Alert	Privately page an individual by sending an audible tone.
Carrier Squelch	Feature that responds to the presence of an RF carrier by opening or unmuting (turning on) a receiver's audio circuit. A squelch circuit silences the radio when no signal is being received so that the user does not have to listen to "noise".
Central Controller	A software-controlled, computer-driven device that receives and generates data for the trunked radios assigned to it. It monitors and directs the operations of the trunked repeaters.
Channel	A group of characteristics such as transmit/receive frequency pairs, radio parameters, and encryption encoding.

Term	Definition
Control Channel	In a trunking system, one of the channels that is used to provide a continuous, two-way/data communications path between the central controller and all radios on the system.
Conventional	Typically refers to radio-to-radio communications, sometimes through a repeater (see Trunking).
Conventional Scan List	A scan list that includes only conventional channels.
COTS	Commercial Off-The-Shelf
Deadlock	Displayed by the radio on a DRSM after three failed attempts to unlock the radio. The radio must be powered off and on prior to another attempt.
Digital Private Line (DPL)	A type of coded squelch using data bursts. Similar to PL except a digital code is used instead of a tone.
Digital Signal	An RF signal that has a pulsed, or discrete, nature, rather than a continuous nature.
Dispatcher	An individual who has radio system management duties.
DRSM	Display Remote Speaker Microphone

Term	Definition
Dynamic Regrouping	A feature that allows the dispatcher to temporarily reassign selected radios to a single special channel so they can communicate with each other.
Failsoft	A feature that allows communications to take place even though the central controller has failed. Each trunked repeater in the system transmits a data word informing every radio that the system has gone into failsoft.
FCC	Federal Communications Commission.
FM	Frequency Modulation
GCAI	Global Common Accessory Interface
Hang Up	Disconnect.
Home screen	The first display information on a DRSM after the radio completes its self test.
KVL	Key-variable loader: A device for loading encryption keys into the radio.
LCD	Liquid crystal display.
LED	Light-emitting diode.
Li-Ion	Lithium ion.

Term	Definition
Man Down	A life-saving feature that senses the radio user may be in trouble by monitoring whether the radio is in a vertical or horizontal position or whether the radio is motionless. When this feature is triggered, the radio alerts the user with audio and visual alerts. It can also trigger Emergency Alarm if enabled.
MCW	Mission Critical Wireless
Monitor	Check channel activity by pressing the Monitor button. If the channel is clear, you hear static. If the channel is in use, you hear conversation. It also serves as a way to check the volume level of the radio, since the radio “opens the squelch” when the monitor button is pressed.
Multi-System Talkgroup Scan List	A scan list that can include both talkgroups (trunked) and channels (conventional).
Network Access Code	Network Access Code (NAC) operates on digital channels to reduce voice channel interference between adjacent systems and sites.
NiMH	Nickel-metal-hydride.

Term	Definition
Non-Tactical/ Revert	The user talks on a preprogrammed emergency channel. The emergency alarm is sent out on this same channel.
OCW	Operation Critical Wireless
OTAR	Over-the-air rekeying.
Page	A one-way alert, with audio and/or display messages.
Personality	A set of unique features specific to a radio.
Preprogrammed	Refers to a software feature that has been activated by a qualified radio technician.
Private Line (PL)	A sub-audible tone that is transmitted such that only receivers decoding the tone receives it.
Programmable	Refers to a radio control that can have a radio feature assigned to it.
PTT	Push-To-Talk – the PTT button engages the transmitter and puts the radio in transmit (send) operation when pressed.
Radio Frequency (RF)	The part of the general frequency spectrum between the audio and infrared light regions (about 10 kHz to 10,000,000 MHz).

Term	Definition
Repeater	A conventional radio feature, where you talk through a receive/transmit facility that re-transmits received signals, in order to improve communications range and coverage.
Selective Switch	Any digital P25 traffic having the correct Network Access Code and the correct talkgroup.
Squelch	Special electronic circuitry, added to the receiver of a radio, that reduces, or cuts off, unwanted signals before they are heard in the speaker.
Standby	An operating condition whereby the radio's speaker is muted but still continues to receive data.
Status Calls	Pre-defined text messages that allow the user to send a conditional message without talking.

Term	Definition
Tactical/ Non-Revert	The user talks on the channel that was selected before the radio entered the emergency state.
Talkaround	Bypass a repeater and talk directly to another unit for easy local unit-to-unit communications.
Talkgroup	An organization or group of radio users who communicate with each other using the same communication path.
Trunking	The automatic sharing of communications paths between a large number of users (see Conventional).
Trunking Priority Monitor Scan List	A scan list that includes talkgroups that are all from the same trunking system.
USK	Unique Shadow Key.
Zone	A grouping of channels.

Commercial Warranty

Limited Warranty

MOTOROLA COMMUNICATION PRODUCTS

I. WHAT THIS WARRANTY COVERS AND FOR HOW LONG:

MOTOROLA SOLUTIONS INC. ("MOTOROLA") warrants the MOTOROLA manufactured Communication Products listed below ("Product") against defects in material and workmanship under normal use and service for a period of time from the date of purchase as scheduled below:

ASTRO APX 3000 Portable Units	One (1) Year
Product Accessories	One (1) Year

MOTOROLA, at its option, will at no charge either repair the Product (with new or reconditioned parts), replace it (with a new or reconditioned Product), or refund the purchase price of the Product during the warranty period provided it is returned in accordance with the terms of this warranty. Replaced parts or boards are warranted for the balance of the original applicable warranty period. All replaced parts of Product shall become the property of MOTOROLA.

This express limited warranty is extended by MOTOROLA to the original end user purchaser only and is not assignable or transferable to any other party. This is the complete warranty for the

Product manufactured by MOTOROLA. MOTOROLA assumes no obligations or liability for additions or modifications to this warranty unless made in writing and signed by an officer of MOTOROLA.

Unless made in a separate agreement between MOTOROLA and the original end user purchaser, MOTOROLA does not warrant the installation, maintenance or service of the Product.

MOTOROLA cannot be responsible in any way for any ancillary equipment not furnished by MOTOROLA which is attached to or used in connection with the Product, or for operation of the Product with any ancillary equipment, and all such equipment is expressly excluded from this warranty. Because each system which may use the Product is unique, MOTOROLA disclaims liability for range, coverage, or operation of the system as a whole under this warranty.

II. GENERAL PROVISIONS:

This warranty sets forth the full extent of MOTOROLA'S responsibilities regarding the Product. Repair, replacement or refund of the purchase price, at MOTOROLA'S option, is the exclusive remedy. THIS WARRANTY IS GIVEN IN LIEU OF ALL OTHER EXPRESS WARRANTIES. IMPLIED WARRANTIES, INCLUDING WITHOUT LIMITATION, IMPLIED WARRANTIES OF MERCHANTABILITY AND FITNESS FOR A PARTICULAR PURPOSE, ARE LIMITED TO THE DURATION OF THIS LIMITED WARRANTY. IN NO EVENT SHALL MOTOROLA BE LIABLE FOR DAMAGES IN EXCESS OF THE PURCHASE PRICE OF THE PRODUCT, FOR ANY LOSS OF USE, LOSS OF TIME, INCONVENIENCE, COMMERCIAL LOSS, LOST PROFITS OR SAVINGS OR OTHER INCIDENTAL, SPECIAL OR CONSEQUENTIAL DAMAGES ARISING OUT OF THE USE OR

INABILITY TO USE SUCH PRODUCT, TO THE FULL EXTENT SUCH MAY BE DISCLAIMED BY LAW.

III. STATE LAW RIGHTS:

SOME STATES DO NOT ALLOW THE EXCLUSION OR LIMITATION OF INCIDENTAL OR CONSEQUENTIAL DAMAGES OR LIMITATION ON HOW LONG AN IMPLIED WARRANTY LASTS, SO THE ABOVE LIMITATION OR EXCLUSIONS MAY NOT APPLY.

This warranty gives specific legal rights, and there may be other rights which may vary from state to state.

IV. HOW TO GET WARRANTY SERVICE:

You must provide proof of purchase (bearing the date of purchase and Product item serial number) in order to receive warranty service and, also, deliver or send the Product item, transportation and insurance prepaid, to an authorized warranty service location. Warranty service will be provided by MOTOROLA through one of its authorized warranty service locations. If you first contact the company which sold you the Product (e.g., dealer or communication service provider), it can facilitate your obtaining warranty service. You can also call MOTOROLA at 1-800-927-2744 US/Canada.

V. WHAT THIS WARRANTY DOES NOT COVER:

- A) Defects or damage resulting from use of the Product in other than its normal and customary manner.
- B) Defects or damage from misuse, accident, water, or neglect.

- C) Defects or damage from improper testing, operation, maintenance, installation, alteration, modification, or adjustment.
- D) Breakage or damage to antennas unless caused directly by defects in material workmanship.
- E) A Product subjected to unauthorized Product modifications, disassembles or repairs (including, without limitation, the addition to the Product of non-MOTOROLA supplied equipment) which adversely affect performance of the Product or interfere with MOTOROLA's normal warranty inspection and testing of the Product to verify any warranty claim.
- F) Product which has had the serial number removed or made illegible.
- G) Rechargeable batteries if:
 - (1) any of the seals on the battery enclosure of cells are broken or show evidence of tampering.
 - (2) the damage or defect is caused by charging or using the battery in equipment or service other than the Product for which it is specified.
- H) Freight costs to the repair depot.
- I) A Product which, due to illegal or unauthorized alteration of the software/firmware in the Product, does not function in accordance with MOTOROLA's published specifications or the FCC certification labeling in effect for the Product at the time the Product was initially distributed from MOTOROLA.
- J) Scratches or other cosmetic damage to Product surfaces that does not affect the operation of the Product.
- K) Normal and customary wear and tear.

VI. PATENT AND SOFTWARE PROVISIONS:

MOTOROLA will defend, at its own expense, any suit brought against the end user purchaser to the extent that it is based on a claim that the Product or parts infringe a United States patent, and MOTOROLA will pay those costs and damages finally awarded against the end user purchaser in any such suit which are attributable to any such claim, but such defense and payments are conditioned on the following:

- A) that MOTOROLA will be notified promptly in writing by such purchaser of any notice of such claim;
- B) that MOTOROLA will have sole control of the defense of such suit and all negotiations for its settlement or compromise; and
- C) should the Product or parts become, or in MOTOROLA's opinion be likely to become, the subject of a claim of infringement of a United States patent, that such purchaser will permit MOTOROLA, at its option and expense, either to procure for such purchaser the right to continue using the Product or parts or to replace or modify the same so that it becomes non-infringing or to grant such purchaser a credit for the Product or parts as depreciated and accept its return. The depreciation will be an equal amount per year over the lifetime of the Product or parts as established by MOTOROLA.

MOTOROLA will have no liability with respect to any claim of patent infringement which is based upon the combination of the Product or parts furnished hereunder with software, apparatus or devices not furnished by MOTOROLA, nor will MOTOROLA have any liability for the use of ancillary equipment or software not furnished by MOTOROLA which is attached to or used in connection with the Product. The foregoing states the entire liability of MOTOROLA with respect to infringement of patents by the Product or any parts thereof.

Laws in the United States and other countries preserve for MOTOROLA certain exclusive rights for copyrighted MOTOROLA software such as the exclusive rights to reproduce in copies and distribute copies of such MOTOROLA software. MOTOROLA software may be used in only the Product in which the software was originally embodied and such software in such Product may not be replaced, copied, distributed, modified in any way, or used to produce any derivative thereof. No other use including, without limitation, alteration, modification, reproduction, distribution, or reverse engineering of such MOTOROLA software or exercise of rights in such MOTOROLA software is permitted. No license is granted by implication, estoppel or otherwise under MOTOROLA patent rights or copyrights.

VII. GOVERNING LAW:

This Warranty is governed by the laws of the State of Illinois, U.S.A.

VIII. FOR AUSTRALIA ONLY:

This warranty is given by Motorola Solutions Australia Pty Limited (ABN 16 004 742 312) of Tally Ho Business Park, 10 Wesley Court. Burwood East, Victoria.

Our goods come with guarantees that cannot be excluded under the Australia Consumer Law. You are entitled to a replacement or refund for a major failure and compensation for any other reasonably foreseeable loss or damage. You are also entitled to have the goods repaired or replaced if the goods fail to be of acceptable quality and the failure does not amount to a major failure.

Motorola Solutions Australia's limited warranty below is in addition to any rights and remedies you may have under the Australian Consumer Law. If you have any queries, please call Motorola Solutions Australia at 1800 457 439. You may also visit our website: http://www.motorolasolutions.com/XA-EN/Pages/Contact_Us for the most updated warranty terms.

Notes



MOTOROLA

Motorola Solutions, Inc.
1303 East Algonquin Road
Schaumburg, Illinois 60196 U.S.A.

MOTOROLA, MOTO, MOTOROLA SOLUTIONS and the Stylized M logo are trademarks or registered trademarks of Motorola Trademark Holdings, LLC and are used under license. All other trademarks are the property of their respective owners.

© 2012 – 2013 Motorola Solutions, Inc. All rights reserved.
November 2013.



68012007043-D

