



# Wireless Access Point User's Guide

October 2018  
Release 8.5



© 2018 Riverbed Technology, Inc. All rights reserved.

Riverbed and any Riverbed product or service name or logo used herein are trademarks of Riverbed. All other trademarks used herein belong to their respective owners. The trademarks and logos displayed herein cannot be used without the prior written consent of Riverbed or their respective owners.

Akamai® and the Akamai wave logo are registered trademarks of Akamai Technologies, Inc. SureRoute is a service mark of Akamai. Apple and Mac are registered trademarks of Apple, Incorporated in the United States and in other countries. Cisco is a registered trademark of Cisco Systems, Inc. and its affiliates in the United States and in other countries. EMC, Symmetrix, and SRDF are registered trademarks of EMC Corporation and its affiliates in the United States and in other countries. IBM, iSeries, and AS/400 are registered trademarks of IBM Corporation and its affiliates in the United States and in other countries. Juniper Networks and Junos are registered trademarks of Juniper Networks, Incorporated in the United States and other countries. Linux is a trademark of Linus Torvalds in the United States and in other countries. Microsoft, Windows, Vista, Outlook, and Internet Explorer are trademarks or registered trademarks of Microsoft Corporation in the United States and in other countries. Oracle and JInitiator are trademarks or registered trademarks of Oracle Corporation in the United States and in other countries. UNIX is a registered trademark in the United States and in other countries, exclusively licensed through X/Open Company, Ltd. VMware, ESX, ESXi are trademarks or registered trademarks of VMware, Inc. in the United States and in other countries.

This product includes Windows Azure Linux Agent developed by the Microsoft Corporation (<http://www.microsoft.com/>). Copyright 2016 Microsoft Corporation.

This product includes software developed by the University of California, Berkeley (and its contributors), EMC, and Comtech AHA Corporation. This product is derived from the RSA Data Security, Inc. MD5 Message-Digest Algorithm.

The SteelHead Mobile Controller (virtual edition) includes VMware Tools. Portions Copyright © 1998-2018 VMware, Inc. All Rights Reserved.

NetApp Manageability Software Development Kit (NM SDK), including any third-party software available for review with such SDK which can be found at <http://communities.netapp.com/docs/DOC-1152>, and are included in a NOTICES file included within the downloaded files.

For a list of open source software (including libraries) used in the development of this software along with associated copyright and license agreements, see the Riverbed Support site at <https://support.riverbed.com>.

This documentation is furnished "AS IS" and is subject to change without notice and should not be construed as a commitment by Riverbed. This documentation may not be copied, modified or distributed without the express authorization of Riverbed and may be used only in connection with Riverbed products and services. Use, duplication, reproduction, release, modification, disclosure or transfer of this documentation is restricted in accordance with the Federal Acquisition Regulations as applied to civilian agencies and the Defense Federal Acquisition Regulation Supplement as applied to military agencies. This documentation qualifies as "commercial computer software documentation" and any use by the government shall be governed solely by these terms. All other use is prohibited. Riverbed assumes no responsibility or liability for any errors or inaccuracies that may appear in this documentation.

For compliance statements and warranty and license agreements, please see "Notices (XA, XD and XR500/600 Series Only)" on page 557 and "Notices (XR-1000 to XR-6000 Indoor Models)" on page 577.



Riverbed Technology  
680 Folsom Street  
San Francisco, CA 94107  
[www.riverbed.com](http://www.riverbed.com)

Part Number  
712-00344-01 Rev A

# Table of Contents

<b>List of Figures.....</b>	<b>xv</b>
<b>Introduction .....</b>	<b>1</b>
The Riverbed Wireless Products .....	1
Nomenclature .....	2
Why Choose the Riverbed Access Point? .....	3
Wireless Access Point Product Overview .....	4
XD Wireless AP Product Family .....	5
XD2-230 2-Radio Access Points .....	5
XD2-240 2-Radio Access Points .....	6
XD4-130 4-Radio High Density Access Points .....	7
XD4-240 / XA4-240 4-Radio Access Points .....	8
XH2 Series 2-Radio Outdoor Access Points .....	9
XR Wireless AP Product Family .....	10
XR-320 Wall Mounted 2-Radio Access Points .....	10
X2-120 Ceiling Mount 2-Radio Access Points .....	11
XR-500 Series 2-Radio Access Points .....	12
XR-600 Series 2-Radio Access Points .....	13
XR-2006 Series 2- and 4-Radio High Density Access Points .....	14
XR-2005 Series 2- and 4-Radio Access Points .....	15
XR-4006 Series 4- to 8-Radio High Density Access Points .....	16
XR-4000 Series 4- to 8-Radio High Density APs (not ending in "6") .....	17
XR-6000 Series 8- to 16-Radio High Density Access Points .....	18
Enterprise Class Security .....	18
Deployment Flexibility .....	19
Power over Ethernet (PoE) .....	20
Enterprise Class Management .....	20
Key Features and Benefits .....	22
Extended Coverage .....	22
Flexible Coverage Schemes .....	23
Non-Overlapping Channels .....	23
SDMA Optimization .....	24
Fast Roaming .....	24

Ease of Deployment .....	24
Powerful Management .....	24
Secure Wireless Access .....	24
Applications Enablement .....	24
Advanced Feature Sets .....	25
Riverbed Advanced RF Performance Manager (RPM) .....	25
Riverbed Advanced RF Security Manager (RSM) .....	26
Riverbed Advanced RF Analysis Manager (RAM) .....	27
Riverbed Application Control .....	28
About this User's Guide .....	28
Organization .....	28
Notes and Cautions .....	30
Screen Images .....	31
Product Specifications .....	31
<b>Installing the Wireless AP .....</b>	<b>33</b>
Installation Prerequisites .....	33
Optional Network Components .....	35
Client Requirements .....	35
Planning Your Installation .....	36
General Deployment Considerations .....	36
Coverage and Capacity Planning .....	38
Placement .....	38
RF Patterns .....	39
Capacity and Cell Sizes .....	40
Fine Tuning Cell Sizes .....	41
Roaming Considerations .....	43
Allocating Channels .....	43
Other Factors Affecting Throughput .....	45
About IEEE 802.11ac .....	46
Up to Eight Simultaneous Data Streams—Spatial Multiplexing .....	48
MIMO (Multiple-In Multiple-Out) .....	48
MU-MIMO (Multi-User Multiple-In Multiple-Out) .....	49
Higher Precision in the Physical Layer .....	51
Higher Channel Widths (Bonding) .....	52
802.11ac Data Rates .....	53
ACExpress™ .....	54



802.11ac Deployment Considerations .....	54
Failover Planning .....	56
Switch Failover Protection .....	58
Power Planning .....	59
Power over Ethernet .....	59
Security Planning .....	60
Wireless Encryption .....	60
Authentication .....	60
Meeting PCI DSS Standards .....	61
Meeting FIPS Standards .....	61
Port Requirements .....	62
Network Management Planning .....	66
WDS Planning .....	67
Common Deployment Options .....	70
Installation Workflow .....	71
Installing Your Wireless AP .....	73
Choosing a Location .....	73
Wiring Considerations .....	73
Mounting and Connecting the AP .....	76
Dismounting the AP .....	76
Powering Up the Wireless AP .....	76
AP LED Operating Sequences .....	77
LED Boot Sequence .....	77
LED Operation when AP is Running .....	78
Zero-Touch Provisioning and Ongoing Management .....	79
XMS-Cloud Next Generation (XMS-9500-CL-x) .....	79
XMS-Enterprise .....	79
If you are not using XMS .....	80
AP Management Interfaces .....	80
User Interfaces .....	80
Using the Serial Port .....	82
Using the Ethernet Ports to Access the AP .....	82
Starting the WMI .....	83
Logging In .....	83
Licensing .....	84
Performing the Express Setup Procedure .....	84
Securing Low Level Access to the AP .....	85

---

<b>The Windows Management Interface .....</b>	<b>89</b>
Managing APs Locally or Using XMS .....	89
IPv6 .....	90
An Overview .....	91
Structure of the WMI .....	92
User Interface .....	94
Logging In .....	97
Applying Configuration Changes .....	98
Character Restrictions .....	98
<b>Viewing Status on the Wireless AP .....</b>	<b>99</b>
Access Point Status Windows .....	100
Access Point Summary .....	100
Content of the Access Point Summary Window .....	101
Access Point Information .....	106
Access Point Configuration .....	107
Admin History .....	108
Network Status Windows .....	108
Network .....	109
Network Map .....	110
Content of the Network Map Window .....	110
Spanning Tree Status .....	113
Routing Table .....	114
ARP Table .....	114
DHCP Leases .....	115
Connection Tracking/NAT .....	115
CDP List .....	116
LLDP List .....	117
Network Assurance .....	117
Undefined VLANs .....	118
RF Monitor Windows .....	119
IAP Monitoring .....	120
Spectrum Analyzer .....	121
Rogues .....	124
Channel History .....	126
Radio Assurance .....	128
Station Status Windows .....	130

Stations .....	131
Location Map .....	133
RSSI .....	136
Signal-to-Noise Ratio (SNR) .....	138
Noise Floor .....	139
Max by IAP .....	141
Station Assurance .....	142
Statistics Windows .....	143
IAP Statistics Summary .....	143
Per-IAP Statistics .....	144
Network Statistics .....	146
VLAN Statistics .....	147
WDS Statistics .....	148
IDS Statistics .....	149
Filter Statistics .....	151
Station Statistics .....	151
Per-Station Statistics .....	153
Application Control Windows .....	154
About Application Control .....	154
Application Control .....	156
Stations (Application Control) .....	160
System Log Window .....	161
IDS Event Log Window .....	162
<b>Configuring the Wireless AP .....</b>	<b>165</b>
Express Setup .....	167
Network .....	173
Interfaces .....	174
Network Interface Ports .....	175
Bonds and Bridging .....	177
DNS Settings .....	184
Cisco Discovery Protocol (CDP) Settings .....	185
LLDP Settings .....	186
Services .....	189
Time Settings (NTP) .....	190
NetFlow .....	193
Wi-Fi Tag .....	194

---

Location .....	195
System Log .....	197
About Using Splunk for Riverbed APs .....	200
SNMP .....	201
DHCP Server .....	204
Proxy Services .....	206
About Proxy Forwarding .....	207
Proxy Forwarding for HTTPS .....	208
Summary of Proxy Forwarding Behavior on the AP .....	209
About Using a Proxy Client for Management Traffic .....	214
VLANs .....	217
Understanding Virtual Tunnels .....	218
VLAN Pools .....	219
VLAN Management .....	221
Tunnels .....	225
About Riverbed Tunnels .....	225
Tunnel Management .....	226
SSID Assignments .....	228
VLAN Assignments .....	229
Security .....	230
Understanding Security .....	231
Certificates and Connecting Securely to the WMI .....	234
Using the AP's Default Certificate .....	235
Using an External Certificate Authority .....	236
Admin Management .....	236
Admin Privileges .....	238
Admin RADIUS .....	240
About Creating Admin Accounts on the RADIUS Server .....	240
Management Control .....	243
Access Control List .....	253
Global Settings .....	255
External Radius .....	259
About Creating User Accounts on the RADIUS Server .....	260
Internal Radius .....	264
Active Directory .....	266
Rogue Control List .....	270
OAuth 2.0 Management .....	271

---

SSIDs .....	274
Understanding SSIDs .....	275
Understanding QoS Priority on the Wireless AP .....	277
High Density 2.4G Enhancement—HoneyPot SSID .....	281
SSID Management .....	283
SSID List (top of page) .....	284
SSID Limits and Scheduling .....	290
Web Page Redirect (Captive Portal) Configuration .....	293
Whitelist Configuration for Web Page Redirect .....	299
Web Page Redirect for Purple WiFi Venues .....	300
WPA Configuration .....	303
Authentication Service Configuration .....	303
Active IAPs .....	304
Per-SSID Access Control List .....	305
HoneyPots .....	306
Personal Wi-Fi .....	308
Groups .....	310
Understanding Groups .....	310
Using Groups .....	311
Group Management .....	312
Group Limits .....	315
IAPs .....	317
Understanding Fast Roaming .....	318
IAP Settings .....	319
Global Settings .....	325
Beacon Configuration .....	327
Station Management .....	328
Advanced Traffic Optimization .....	330
Global Settings .11an .....	341
Global Settings .11bgn .....	347
Global Settings .11n .....	353
Global Settings .11ac .....	356
Global Settings .11u .....	358
Understanding 802.11u .....	358
Advanced RF Settings .....	364
About Standby Mode .....	365
RF Monitor .....	365

---

RF Resilience .....	366
RF Power and Sensitivity .....	367
RF Spectrum Management .....	368
Station Assurance .....	371
Hotspot 2.0 .....	373
Understanding Hotspot 2.0 .....	373
NAI Realms .....	375
Understanding NAI Realm Authentication .....	375
Intrusion Detection .....	378
DoS Attacks .....	379
Impersonation Attacks .....	380
About Blocking Rogue APs .....	381
RF Intrusion Detection and Auto Block Mode .....	382
DoS Attack Detection Settings .....	384
Impersonation Detection Settings .....	385
LED Settings .....	385
DSCP Mappings .....	387
Roaming Assist .....	388
WDS .....	391
About Configuring WDS Links .....	391
Long Distance Links .....	393
WDS Client Links .....	394
Filters .....	398
Filter Management .....	399
Filters .....	400
Custom Application List .....	405
Mobile .....	407
AirWatch .....	407
User Procedure for Wireless Access .....	409
<b>Using Tools on the Wireless AP .....</b>	<b>411</b>
System Tools .....	412
About Licensing and Upgrades .....	412
System .....	414
Remote Boot Services .....	416
Configuration Management .....	418
Diagnostics .....	421

Application Control Signature File Management .....	422
Web Page Redirect (Captive Portal) .....	424
Network Tools .....	425
Progress Bar and Status Frame .....	427
CLI .....	427
API Documentation .....	429
Status/Settings .....	430
GET Requests .....	431
Trying a GET Request .....	431
API Documentation Toolbar .....	433
Options .....	434
Logout .....	435
<b>The Command Line Interface .....</b>	<b>437</b>
Establishing a Secure Shell (SSH) Connection .....	437
Getting Started with the CLI .....	439
Entering Commands .....	439
IPv4 and IPv6 .....	439
Getting Help .....	439
Top Level Commands .....	442
Root Command Prompt .....	442
configure Commands .....	443
show Commands .....	447
statistics Commands .....	452
Configuration Commands .....	454
acl .....	454
admin .....	455
auth .....	456
bluetooth .....	457
cdp .....	458
clear .....	459
cluster .....	461
contact-info .....	463
date-time .....	464
device-id .....	465
dhcp-server .....	466
dns .....	467

---

file .....	468
filter .....	472
Air Cleaner .....	473
group .....	476
hostname .....	476
interface .....	477
WDS Lock .....	478
Multicast Traffic Isolation (supports Airplay and mDNS service) .....	478
load .....	480
location .....	480
location-reporting .....	481
management .....	483
mdm .....	485
more .....	486
netflow .....	487
no .....	488
quick-config .....	489
quit .....	490
authentication-server .....	490
reboot .....	492
reset .....	492
restore .....	493
roaming-assist .....	494
run-tests .....	495
security .....	497
snmp .....	498
ssid .....	499
Fast Transition Configuration (dot11r) .....	499
Web Page Redirect—HTTPS Pass-through for Facebook Wi-Fi .....	500
syslog .....	501
tunnel .....	502
uptime .....	503
vlan .....	504
wifi-tag .....	505
Sample Configuration Tasks .....	506
Configuring a Simple Open Global SSID .....	507
Configuring a Global SSID using WPA-PEAP .....	508



Configuring an SSID-Specific SSID using WPA-PEAP .....	509
Enabling Global IAPs .....	510
Disabling Global IAPs .....	511
Enabling a Specific IAP .....	512
Disabling a Specific IAP .....	513
Setting Cell Size Auto-Configuration for All IAPs .....	514
Setting the Cell Size for All IAPs .....	515
Setting the Cell Size for a Specific IAP .....	516
Configuring VLANs on an Open SSID .....	517
Configuring Radio Assurance Mode (Loopback Tests) .....	518
<b>Appendices .....</b>	<b>521</b>
<b>Appendix A: Quick Reference Guide .....</b>	<b>523</b>
Factory Default Settings .....	523
Host Name .....	523
Network Interfaces .....	523
Serial .....	523
Gigabit 1 and Gigabit 2 .....	524
Server Settings .....	524
NTP .....	524
Syslog .....	524
SNMP .....	525
DHCP .....	525
Default SSID .....	526
Security .....	526
Global Settings - Encryption .....	526
External RADIUS (Global) .....	527
Internal RADIUS .....	528
Administrator Account and Password .....	528
Management .....	528
Keyboard Shortcuts .....	529
<b>Appendix B: FAQ and Special Topics .....</b>	<b>531</b>
General Hints and Tips .....	531
Frequently Asked Questions .....	532
Multiple SSIDs .....	532
Security .....	534

---

VLAN Support .....	537
ArrayOS Traps .....	539
AP Monitor and Radio Assurance Capabilities .....	541
Enabling Monitoring on the AP .....	541
How Monitoring Works .....	541
Radio Assurance .....	542
Radio Assurance Options .....	543
RADIUS Vendor Specific Attribute (VSA) for Riverbed .....	544
Location Service Data Formats .....	545
Euclid Location Server .....	545
Non-Euclid Location Server .....	545
Data Format Table .....	545
Upgrading the AP Using the Boot Loader .....	551
Sample Output for the Upgrade Procedure: .....	553

**Appendix C: Notices (XA, XD and XR500/600 Series Only) ... 557**

Notices .....	557
EU Compliance Information .....	565
Compliance Information (Non-EU) .....	572
Safety Warnings .....	574
Translated Safety Warnings .....	575
Software and Hardware License and Warranty Agreement .....	576

**Appendix D: Notices (XR-1000 to XR-6000 Indoor Models) ... 577**

Notices .....	577
EU Compliance Information .....	582
Compliance Information (Non-EU) .....	589
Safety Warnings .....	591
Translated Safety Warnings .....	592
Software and Hardware License and Warranty Agreement .....	594

**Appendix E: Medical Usage Notices ..... 595**

**Appendix F: Auditing PCI DSS ..... 603**

Payment Card Industry Data Security Standard Overview .....	603
PCI DSS and Wireless .....	604
The Riverbed AP PCI Compliance Configuration .....	605
The pci-audit Command .....	606

Additional Resources .....	607
<b>Appendix G: Implementing FIPS Security .....</b>	<b>609</b>
Securing the AP Physically .....	609
Operator Required Actions .....	609
Applying Tamper Evident Seals .....	610
To implement FIPS 140-2, Level 2 using WMI .....	611
To implement FIPS 140-2, Level 2 using CLI: .....	614
To check if AP is in FIPS mode: .....	614
About FIPS Configuration .....	615
<b>Glossary of Terms.....</b>	<b>617</b>
<b>Index.....</b>	<b>629</b>



# List of Figures

Figure 1.	Riverbed AP .....	1
Figure 2.	Wireless AP (XR Series) .....	4
Figure 3.	Wireless Coverage Patterns .....	19
Figure 4.	XP8 - Power over Ethernet Usage .....	20
Figure 5.	WMI: AP Status.....	21
Figure 6.	Coverage Schemes (XR-7230 shown).....	23
Figure 7.	Wall Thickness Considerations .....	37
Figure 8.	Unit Placement.....	38
Figure 9.	Full (Normal) Coverage.....	39
Figure 10.	Adjusting RF Patterns .....	39
Figure 11.	Custom Coverage .....	40
Figure 12.	Connection Rate vs. Distance.....	40
Figure 13.	Transmit Power.....	41
Figure 14.	Auto Cell Size Options.....	42
Figure 15.	Overlapping Cells.....	43
Figure 16.	Allocating Channels Manually .....	44
Figure 17.	Spatial Multiplexing.....	48
Figure 18.	MIMO Signal Processing.....	49
Figure 19.	MU-MIMO with Four Antennas .....	50
Figure 20.	Physical Layer Data Encoding.....	51
Figure 21.	Channel Bonding (Channels 36-64 shown).....	53
Figure 22.	Maximum 802.11ac Data Rates.....	53
Figure 23.	Port Failover Protection .....	56
Figure 24.	Switch Failover Protection .....	58
Figure 25.	Port Requirements for XMS-Enterprise.....	62
Figure 26.	WDS Link.....	67
Figure 27.	A Multiple Hop WDS Connection .....	68
Figure 28.	WDS Failover Protection .....	68
Figure 29.	Installation Workflow .....	71
Figure 30.	AP Placement .....	73
Figure 31.	LED Locations .....	76
Figure 32.	Network Interface Ports—XR-520 (left); XR-1000 Series (right) .....	80
Figure 33.	Network Interface Ports—XR-600 Series .....	81
Figure 34.	Network Interfaces—XR-2000 Series (left); XR-2005/2006 (right) ....	81

Figure 35.	Network Interface Ports—XR-4000 Series .....	81
Figure 36.	Network Interface Ports—XR-6000 Series .....	81
Figure 37.	Windows Management Interface .....	91
Figure 38.	WMI: Frames .....	94
Figure 39.	WMI Header .....	95
Figure 40.	WMI Command Log .....	96
Figure 41.	WMI: Utility Buttons .....	96
Figure 42.	Logging In to the Wireless AP .....	97
Figure 43.	AP Summary .....	100
Figure 44.	Disabled IAP (Partial View) .....	103
Figure 45.	IAP Cells .....	103
Figure 46.	Network Assurance and Operating Status .....	104
Figure 47.	AP Information .....	106
Figure 48.	Show Configuration .....	107
Figure 49.	Admin Login History .....	108
Figure 50.	Network Settings .....	109
Figure 51.	Network Map .....	110
Figure 52.	Spanning Tree Status .....	113
Figure 53.	Routing Table .....	114
Figure 54.	ARP Table .....	114
Figure 55.	DHCP Leases .....	115
Figure 56.	Connection Tracking .....	115
Figure 57.	CDP List .....	116
Figure 58.	LLDP List .....	117
Figure 59.	Network Assurance .....	117
Figure 60.	Undefined VLANs .....	118
Figure 61.	RF Monitor—IAPs .....	120
Figure 62.	RF Monitor—IAPs .....	120
Figure 63.	RF Spectrum Analyzer .....	122
Figure 64.	Intrusion Detection/Rogue AP List .....	124
Figure 65.	RF Monitor—Channel History .....	126
Figure 66.	RF Monitor—Channel History (Rotated) .....	127
Figure 67.	RF Monitor—Channel History (Text) .....	127
Figure 68.	Radio Assurance .....	128
Figure 69.	Stations .....	131
Figure 70.	Location Map .....	133
Figure 71.	Controls for Location Map .....	134

Figure 72.	Station RSSI Values .....	136
Figure 73.	Station RSSI Values—Colorized Graphical View .....	137
Figure 74.	Station Signal-to-Noise Ratio Values .....	138
Figure 75.	Station SNR Values—Colorized Graphical View.....	138
Figure 76.	Station Noise Floor Values .....	139
Figure 77.	Station Noise Floor Values—Colorized Graphical View .....	140
Figure 78.	Max by IAP .....	141
Figure 79.	Station Assurance .....	142
Figure 80.	IAP Statistics Summary Page.....	143
Figure 81.	Individual IAP Statistics Page .....	145
Figure 82.	Network Statistics.....	146
Figure 83.	VLAN Statistics.....	147
Figure 84.	WDS Statistics .....	148
Figure 85.	IDS Statistics Page .....	149
Figure 86.	Filtered IDS Statistics .....	150
Figure 87.	Filter Statistics .....	151
Figure 88.	Station Statistics .....	151
Figure 89.	Individual Station Statistics Page.....	153
Figure 90.	Application Control .....	156
Figure 91.	Application Control (Pie Charts).....	158
Figure 92.	Application Control (Station Traffic).....	159
Figure 93.	Stations (Application Control).....	160
Figure 94.	System Log (Alert Level Highlighted) .....	161
Figure 95.	IDS Event Log .....	162
Figure 96.	WMI: Express Setup .....	167
Figure 97.	LEDs are Switched On .....	172
Figure 98.	Network Interfaces .....	173
Figure 99.	Network Settings .....	174
Figure 100.	Network Bonds and Bridging.....	177
Figure 101.	Bridging Traffic.....	178
Figure 102.	Port Modes (a, b).....	180
Figure 103.	Port Modes (c, d).....	181
Figure 104.	Mirroring Traffic.....	183
Figure 105.	DNS Settings.....	184
Figure 106.	CDP Settings.....	185
Figure 107.	LLDP Settings .....	186
Figure 108.	Services.....	189

---

Figure 109. Time Settings (Manual Time).....	190
Figure 110. Time Settings (NTP Time Enabled).....	191
Figure 111. NetFlow.....	193
Figure 112. Wi-Fi Tag.....	194
Figure 113. Location.....	195
Figure 114. System Log.....	197
Figure 115. SNMP.....	201
Figure 116. DHCP Management.....	204
Figure 117. Proxy Forwarding Example.....	207
Figure 118. Set up a Proxy Server on each Client (Windows).....	210
Figure 119. Specify Proxy Servers (Windows).....	211
Figure 120. Set up a Proxy Server on each Client (Apple).....	212
Figure 121. Specify Proxy Servers (Apple).....	213
Figure 122. Proxy Forwarding.....	214
Figure 123. Proxy Client for Management Traffic.....	215
Figure 124. VLANs.....	217
Figure 125. VLAN Management.....	221
Figure 126. Tunnel Summary.....	225
Figure 127. Tunnel Management.....	226
Figure 128. Tunnel SSID Assignments.....	228
Figure 129. Tunnel VLAN Assignments.....	229
Figure 130. Security.....	230
Figure 131. Import Riverbed Certificate Authority.....	235
Figure 132. Admin Management.....	236
Figure 133. Admin Privileges.....	238
Figure 134. Admin RADIUS.....	241
Figure 135. Management Control.....	243
Figure 136. Pre-login Banner.....	244
Figure 137. Management Transports.....	245
Figure 138. Management Modes.....	247
Figure 139. HTTPS (X.509) Certificate.....	250
Figure 140. External Certificate Authority.....	251
Figure 141. Access Control List.....	253
Figure 142. Global Settings (Security).....	255
Figure 143. External RADIUS Server.....	259
Figure 144. Internal RADIUS Server.....	264
Figure 145. Active Directory Server.....	267



Figure 146. Finding the Domain Name from Active Directory.....	268
Figure 147. Rogue Control List .....	270
Figure 148. OAuth 2.0 Management - Token List .....	272
Figure 149. SSIDs.....	274
Figure 150. Four Traffic Classes .....	277
Figure 151. Priority Level—IEEE 802.1p (Layer 2).....	278
Figure 152. Priority Level—DSCP (DiffServ - Layer 3) .....	278
Figure 153. SSID Management .....	283
Figure 154. SSID Management—Encryption, Authentication, Accounting .....	287
Figure 155. WPR Internal Splash Page Fields (SSID Management).....	293
Figure 156. Customizing an Internal Login or Splash Page.....	298
Figure 157. Whitelist Configuration for WPR.....	299
Figure 158. Purple WiFi Guest Access .....	300
Figure 159. Setting Active IAPs per SSID .....	304
Figure 160. Per-SSID Access Control List .....	305
Figure 161. Honeygot Whitelist .....	307
Figure 162. Personal Wi-Fi.....	308
Figure 163. Groups.....	310
Figure 164. Group Management .....	312
Figure 165. IAPs.....	317
Figure 166. Source of Channel Setting .....	317
Figure 167. IAP Settings .....	319
Figure 168. Global Settings (IAPs).....	325
Figure 169. Multicast Processing .....	330
Figure 170. Additional Optimization Settings .....	336
Figure 171. Global Settings .11an.....	341
Figure 172. Global Settings .11bgn .....	347
Figure 173. Global Settings .11n .....	353
Figure 174. Global Settings .11ac .....	356
Figure 175. 802.11u Global Settings.....	360
Figure 176. Advanced RF Settings.....	364
Figure 177. Station Assurance (Advanced RF Settings) .....	372
Figure 178. Hotspot 2.0 Settings.....	374
Figure 179. NAI Realms .....	376
Figure 180. Intrusion Detection Settings.....	378
Figure 181. LED Settings .....	385
Figure 182. DSCP Mappings.....	387

---

Figure 183. Roaming Assist .....	389
Figure 184. WDS .....	391
Figure 185. Configuring a WDS Link .....	392
Figure 186. WDS Client Links .....	394
Figure 187. Filters .....	398
Figure 188. Filter Lists .....	399
Figure 189. Filters .....	401
Figure 190. AirWatch Settings .....	407
Figure 191. System Tools .....	412
Figure 192. Remote Boot Services .....	416
Figure 193. Configuration Management .....	418
Figure 194. Saving the Diagnostic Log .....	421
Figure 195. Managing Application Control Signature files .....	423
Figure 196. Managing WPR Splash/Login page files .....	424
Figure 197. System Command (Ping) .....	425
Figure 198. Radius Ping Output .....	426
Figure 199. CLI Window .....	427
Figure 200. Accessing API Documentation .....	429
Figure 201. API Documentation .....	430
Figure 202. API — GET Request Details .....	431
Figure 203. API — GET Request Response .....	432
Figure 204. API Documentation Toolbar .....	433
Figure 205. WMI Display Options .....	434
Figure 206. Login Window .....	435
Figure 207. Logging In .....	438
Figure 208. Help Window .....	440
Figure 209. Full Help .....	440
Figure 210. Partial Help .....	441
Figure 211. Air Cleaner Filter Rules .....	474
Figure 212. Configuring a Simple Open Global SSID .....	507
Figure 213. Configuring a Global SSID using WPA-PEAP .....	508
Figure 214. Configuring an SSID-Specific SSID using WPA-PEAP .....	509
Figure 215. Enabling Global IAPs .....	510
Figure 216. Disabling Global IAPs .....	511
Figure 217. Enabling a Specific IAP .....	512
Figure 218. Disabling a Specific IAP .....	513
Figure 219. Setting Cell Size Auto-Configuration for All IAPs .....	514

## Wireless Access Point

---

Figure 220. Setting the Cell Size for All IAPs.....	515
Figure 221. Setting the Cell Size for a Specific IAP .....	516
Figure 222. Configuring VLANs on an Open SSID.....	517
Figure 223. Configuring Radio Assurance Mode (Loopback Testing).....	519
Figure 224. Sample output of pci-audit command.....	607
Figure 225. Tamper Evident Seal Application for Indoor Enclosure .....	610
Figure 226. Tamper Evident Seal Application Close-up .....	611
Figure 227. AP Information .....	612
Figure 228. Security - Management Control Window .....	613



# Introduction

This chapter introduces the Riverbed Wireless Products, with an overview of its key features and benefits.

- [“The Riverbed Wireless Products” on page 1](#)
- [“Why Choose the Riverbed Access Point?” on page 3](#)
- [“Wireless Access Point Product Overview” on page 4](#)
- [“Key Features and Benefits” on page 22](#)
- [“Advanced Feature Sets” on page 25](#)
- [“About this User’s Guide” on page 28](#)

## The Riverbed Wireless Products



Figure 1. Riverbed AP

The Riverbed family of products includes the following:

- **Riverbed High Density Wireless Access Points**  
Riverbed APs are designed to provide distributed intelligence, integrated switching capacity, application-level intelligence, increased bandwidth, and smaller size. The radios support IEEE802.11 ac, a, b, g, and n clients, and feature the capacity and performance needed to replace switched Ethernet to the desktop. Modular radios allow you to increase the number of radios, upgrade to more powerful radios, or even upgrade later to future technologies like 802.11ac and 802.11ad as they are introduced.

- **Xirrus Management System (XMS)**

XMS is used for managing large wireless deployments from a centralized Web-based interface. Riverbed offers XMS-Cloud—a software as a service option for XMS, providing zero-touch provisioning and initial startup for new AP deployments. XMS is capable of managing large numbers of APs, including automated software and firmware upgrades for the network.

Another option is XMS-Enterprise, hosted on your own server. It manages all aspects of your Riverbed wireless network. For detailed information, refer to the *XMS User's Guide*.

- **Riverbed-supplied Power over Ethernet (PoE) Injectors and POE+ Switches**

Riverbed offers 24- and 48-port enterprise-class L2+ gigabit managed access switches with IEEE802.3at PoE+, four 1G/10G SFP+ ports, and stacking. One-, two-, and eight-port PoE injectors are also available for a range of AP power requirements.

## Nomenclature

Throughout this User's Guide, Riverbed Wireless Access Points are referred to as simply APs. In some instances, the terms **product** and **unit** are also used. When discussing specific products from the Riverbed family, the product name is used (for example, XD2-240). The Wireless AP's operating system is referred to as the ArrayOS (AOS). The Windows Management Interface for browser-based management of the AP is referred to as WMI.

APs have very flexible radio capabilities—each of the radios may be independently configured to support IEEE802.11a, 11b, 11g, or 11n clients or a combination of client types. On APs featuring 802.11ac, this option is also included. One radio may be assigned as the RF **monitor** radio, supporting intrusion detection and prevention, self-monitoring, and other services. Radios support both 2.4GHz and 5 GHz, and are named **iap1, iap2, ... iapn**.

The Xirrus Management System is referred to as XMS. The Power over Ethernet system may be referred to as PoE.

## Why Choose the Riverbed Access Point?

The deployment of wireless is a necessity as businesses strive for greater flexibility in the workplace and the need for employee mobility rises. The user community is placing spiraling and often unanticipated demands on the wireless network, with the rapid proliferation of devices such as iPads and wireless enabled phones. Riverbed High Density APs have the capability to support the large number of user devices present in today's environments, with superior range and coverage.

Wireless has come a long way in the past few years and now offers the performance, reliability and security that Enterprise customers have come to expect from their networks. The technology is being driven by these major IEEE standards:

- **802.11ac**  
Operates in the 5 GHz range, using a number of advanced techniques to achieve a maximum bandwidth of 3.47 Gbps per radio. These techniques include improvements on the methods used for 802.11n, below.
- **802.11n**  
Uses multiple antennas per radio to boost transmission speed as high as 450Mbps, increasing throughput, range, and maximum number of users. 802.11n is backwards compatible with 802.11a/b/g.
- **802.11a**  
Operates in the 5 GHz range with a maximum speed of 54 Mbps.
- **802.11b**  
Operates in the 2.4 GHz range with a maximum speed of 11 Mbps.
- **802.11g**  
Supports 54 Mbps in the 2.4 GHz range and is backwards compatible with 802.11b.

Whether you have just a few users or many users, the Riverbed AP has the scalability and flexibility to serve your needs.

*See Also*

[Key Features and Benefits](#)

[Wireless Access Point Product Overview](#)

[The Riverbed Wireless Products](#)

## Wireless Access Point Product Overview

The Wireless AP is a high capacity, multi-mode device designed with up to four times the coverage and eight times the bandwidth and user density compared with legacy thin access point wireless products. Its distributed intelligence eliminates the use of separate controllers and their accompanying bottlenecks. Each radio can achieve up to 3.47 Gbps throughput, depending on the model.



Figure 2. Wireless AP (XR Series)

The Wireless AP (regardless of the product model) is Wi-Fi® compliant and simultaneously supports 802.11ac (on .11ac models), 802.11a, 802.11b, 802.11g, and 802.11n clients. The multi-state design of most Riverbed APs allows you to assign radios to 2.4 GHz and 5 GHz bands (or both) in any desired arrangement. Integrated switching and active enterprise class features such as [VLAN](#) support and multiple [SSID](#) capability enable robust network compatibility and a high level of scalability and system control. IPv6 is supported. The Xirrus Management System (XMS) allows global management of hundreds of APs from a central location.

Multiple versions of the AP with different numbers of radios support a variety of deployment applications.



## XD Wireless AP Product Family

### XD2-230 2-Radio Access Points

These APs have two Gigabit Ethernet ports and two radios supporting 802.11ac Wave 2 and 802.11a/b/g/n. The two radios connect up to 480 users at one time with up to 3.9 Gbps total Wi-Fi bandwidth.

The Riverbed XD2-230 AP is designed for offices, classrooms, meeting spaces and any location where the speed of data delivery is critical. It integrates radios with high gain directional antennas, an onboard multi-gigabit switch, controller, firewall, threat sensor and spectrum analyzer.

Feature	XD2-230
No. radios: 802.11 ac/a/b/g/n/monitor	One 2.4GHz or 5GHz One 5GHz
Radio type	3x3 802.11ac Wave 2
Integrated antennas	6
Integrated wireless switch ports	2
Integrated RF spectrum analyzer, threat sensors	Yes
Gigabit Uplink Ports	Two 1GbE
Wireless bandwidth	3.9 Gbps
Users supported	480

A unique feature optimizes wireless performance by automatically segmenting faster 802.11ac clients from slower Wi-Fi clients. Since Wi-Fi is a shared medium, this separation ensures slower 802.11a/b/g/n clients do not slow down 802.11ac clients and prevent them from achieving high performance.

**XD2-240 2-Radio Access Points**

These APs have two Gigabit Ethernet ports and two multi-state radios (2.4GHz or 5GHz) supporting 802.11ac Wave 2 and 802.11a/b/g/n. The two 802.11ac radios connect up to 480 users at one time with up to 6.9 Gbps total Wi-Fi bandwidth.

The Riverbed XD2-240 AP is designed for offices, classrooms, meeting spaces and any location where the speed of data delivery is critical. It integrates multi-state radios with high gain directional antennas, an onboard multi-gigabit switch, controller, firewall, threat sensor and spectrum analyzer.

Feature	XD2-240
No. radios: 802.11 ac/a/b/g/n/monitor	2
Radio type	4x4 Wave 2
Integrated antennas	8
Integrated wireless switch ports	2
Integrated RF spectrum analyzer, threat sensors	Yes
Gigabit Uplink Ports	2
Wireless bandwidth	6.9 Gbps
Users supported	480

The XD2-240 optimizes wireless performance by automatically segmenting faster 802.11ac clients from slower Wi-Fi clients. Since Wi-Fi is a shared medium, this separation ensures slower 802.11a/b/g/n clients do not slow down 802.11ac clients and prevent them from achieving high performance.

### **XD4-130 4-Radio High Density Access Points**

These APs have two Gigabit Ethernet ports and four multi-state radios (2.4GHz or 5GHz) supporting 802.11ac and 802.11a/b/g/n. Each of the four 3x3 802.11ac radios supports 1.3Gbps, connecting up to 780 users at one time with up to 5.2 Gbps total Wi-Fi bandwidth.

The Riverbed XD4-130 AP supports high-performance for medium density needs. It integrates multi-state radios with high gain directional antennas, an onboard multi-gigabit switch, controller, firewall, threat sensor and spectrum analyzer.

Feature	XD4-130
No. radios: 802.11 ac/a/b/g/n/monitor	4
Radio type	3x3 Wave 1
Integrated antennas	12
Integrated wireless switch ports	4
Integrated RF spectrum analyzer, threat sensors	Yes
Gigabit Uplink Ports	2
Wireless bandwidth	5.2 Gbps
Users supported	780

The XD4-130 optimizes wireless performance by automatically segmenting faster 802.11ac clients from slower Wi-Fi clients. Since Wi-Fi is a shared medium, this separation ensures slower 802.11a/b/g/n clients do not slow down 802.11ac clients and prevent them from achieving high performance.

### XD4-240 / XA4-240 4-Radio Access Points

These APs have four multi-state radios (2.4GHz or 5GHz) supporting 802.11ac Wave 2 with multi-user MIMO (MU-MIMO) and 802.11a/b/g/n. Each of the 4x4 802.11ac radios supports 3.47 Gbps, connecting up to 780 users at one time with up to 13.88 Gbps total Wi-Fi bandwidth. The uplinks include a 2.5 Gigabit Ethernet port and a second 1 Gigabit port.

The Riverbed XD4-240 AP is designed for medium to high density applications such as 1:1 classrooms, lecture halls, meeting rooms, open floor office areas and for Internet of Things (IoT) sensor networks. It integrates multi-state radios with high gain directional antennas, an onboard multi-gigabit switch, controller, firewall, threat sensor and spectrum analyzer.

XA4 Series High Density Convention Center Access Points (CCAPs) are plenum-rated indoor APs. The XA4's features and capabilities are identical to the XD4-240, except for using customer-supplied external antennas rather than internal antennas.

Feature	XD4-240	XA4-240
No. radios: 802.11 ac/a/b/g/n/monitor	4	4
4x4 Wave 2 MU-MIMO Radio	Yes	Yes
Antennas	16, integrated	Up to 16 external
Integrated wireless switch ports	2	2
Integrated RF spectrum analyzer, threat sensors	Yes	Yes
Gigabit Uplink Ports	One 2.5 Gb & one 1Gb	One 2.5 Gb & one 1Gb
Wireless bandwidth	13.88 Gbps	13.88 Gbps
Users supported	780	780

These APs optimize wireless performance by automatically segmenting faster 802.11ac clients from slower Wi-Fi clients. Since Wi-Fi is a shared medium, this separation ensures slower 802.11a/b/g/n clients do not slow down 802.11ac clients and prevent them from achieving high performance.

### XH2 Series 2-Radio Outdoor Access Points

These Access Points provide robust wireless service in challenging outdoor environments. Two Gigabit Ethernet ports and multi-state radios (2.4GHz or 5GHz) support medium to high density deployments.

These models have an integrated controller, firewall, threat sensor spectrum analyzer, and application-level intelligence. They use customer-provided external antennas rather than having integrated antennas. See the Riverbed XH2 Quick Installation Guide for your model for more information.

XH2s optimize wireless performance by automatically segmenting faster 802.11ac clients from slower Wi-Fi clients. Since Wi-Fi is a shared medium, this separation ensures slower 802.11a/b/g/n clients do not slow down 802.11ac clients and prevent them from achieving high performance.

Feature	XH2-120	XH2-240
No. radios: 802.11 ac/a/b/g/n/monitor	Two 2.4GHz/ 5GHz	One 2.4GHz/5GHz + One 5GHz
802.11ac radio type	Wave 1 2x2	Wave 2 4x4
Integrated wireless switch ports	2	2
Integrated RF spectrum analyzer, threat sensors	Yes	Yes
Gigabit Uplink Ports	Two 1GbE	Two 1GbE
Wireless bandwidth	1.7 Gbps	6.9 Gbps
Users supported	480	480

## XR Wireless AP Product Family

### XR-320 Wall Mounted 2-Radio Access Points

The XR-320 is a Gigabit Wi-Fi wall AP with integrated wired 4-port Gigabit switch designed for in-room connectivity. This AP supports 802.11ac standards with two 2x2 Wave 1 radios, and is designed for multi-device wired and wireless connectivity in hotel rooms, dormitories, hospital rooms, offices, and similar locations. Using existing in-wall cabling, the XR-320 delivers Wi-Fi access, connectivity to multiple wired devices and pass-through access for legacy devices like POTS. These models have omni-directional antennas.

Feature	XR-320
No. radios: 802.11 a/b/g/n/ac/Monitor	2
Radio type	2x2
Integrated antennas	4
Integrated wireless switch ports	1
Gigabit Uplink Port	1
Wireless bandwidth	1.1 Gbps
Users supported	256

The XR-320 runs a different operating system than ArrayOS, and the WMI and CLI described in this book **do not apply to the XR-320**. This model should be managed using XMS.

### X2-120 Ceiling Mount 2-Radio Access Points

The X2-120 is a low cost Gigabit Wi-Fi AP with two 2x2 802.11ac Wave 1 radios, optimized for high performance/low complexity networks such as those in classrooms, hotel rooms, hotspots, and SME offices. These models have omnidirectional antennas.

Feature	X2-120
No. radios: 802.11 a/b/g/n/ac/Monitor	2
Radio type	2x2
Integrated antennas	4
Integrated wireless switch ports	1
Gigabit Uplink Port	1
Wireless bandwidth	1.1 Gbps
Users supported	254

The X2-120 runs a different operating system than ArrayOS, and the WMI and CLI described in this book **do not apply to the X2-120**. This model should be managed using XMS.

### XR-500 Series 2-Radio Access Points

These Access Points have one Gigabit Ethernet port and two multi-state radios (2.4GHz or 5GHz). They support 600Mbps total, connecting up to 240 users at one time.

The Access Point provides flexibility for delivering wireless service in low-to-medium user density scenarios, in challenging deployments in areas with high RF attenuation, and in isolated or physically separated locations.

These models have an integrated controller, firewall, threat sensor, and spectrum analyzer. Indoor units have omni-directional antennas rather than directional antennas.

Feature	XR-520
No. radios: 802.11 a/b/g/n/monitor	2
Radio type	2x2
Integrated omni-directional antennas	4
Integrated wireless switch ports	2
Integrated RF spectrum analyzer, threat sensors	Yes
Gigabit Uplink Port	1
Wireless bandwidth	600 Mbps
Users supported	240



### **XR-600 Series 2-Radio Access Points**

These Access Points provide robust wireless service in low-to-medium user density scenarios. They have two Gigabit Ethernet ports and two multi-state radios (2.4GHz or 5GHz), so that as more of your clients migrate to 802.11ac, you can increase the number of radios operating at 5 GHz. Each of the XR-630's two 3x3 802.11ac radios supports 1.3Gbps, connecting up to 240 users at one time with 2.6Gbps total Wi-Fi bandwidth.

These models have an integrated controller, firewall, threat sensor spectrum analyzer, and application-level intelligence. They have omni-directional antennas rather than directional antennas.

The XR-630 supports a unique feature that optimizes wireless performance by automatically segmenting faster 802.11ac clients from slower Wi-Fi clients. Since Wi-Fi is a shared medium, this separation ensures slower 802.11a/b/g/n clients do not slow down 802.11ac clients and prevent them from achieving high performance.

Feature	XR-620	XR-630
No. radios: 802.11 ac/a/b/g/n/monitor	2	2
Radio type	2x2	3x3
Integrated omni-directional antennas	4	6
Integrated wireless switch ports	2	2
Integrated RF spectrum analyzer, threat sensors	Yes	Yes
Gigabit Uplink Ports	2	2
Wireless bandwidth	1.7 Gbps	2.6 Gbps
Users supported	240	240

### XR-2006 Series 2- and 4-Radio High Density Access Points

These APs have two Gigabit Ethernet ports and two or four multi-state radios (2.4GHz or 5GHz) supporting 802.11ac and 802.11a/b/g/n. Each of the XR-2436's four 3x3 802.11ac radios supports 1.3Gbps, connecting up to 512 users at one time with up to 5.2 Gbps total Wi-Fi bandwidth.

The Riverbed XR-2006 Series has a four-slot chassis that allows you to purchase a two-radio model and add more radios later as your needs grow. These models support high-performance for medium to high density needs. Like larger XR APs, these models integrate multi-state radios with high gain directional antennas, an onboard multi-gigabit switch, controller, firewall, threat sensor and spectrum analyzer on a modular chassis designed for extensibility.

Feature	XR-2226	XR-2236	XR-2426	XR-2436
No. radios: 802.11 ac/a/b/g/n/monitor	2	2	4	4
Radio type	2x2	3x3	2x2	3x3
Integrated antennas	4	6	8	12
Integrated wireless switch ports	4	4	4	4
Integrated RF spectrum analyzer, threat sensors	Yes	Yes	Yes	Yes
Gigabit Uplink Ports	2	2	2	2
Wireless bandwidth	1.7 Gbps	2.6 Gbps	3.4 Gbps	5.2 Gbps
Users supported	256	256	512	512

A unique feature optimizes wireless performance by automatically segmenting faster 802.11ac clients from slower Wi-Fi clients. Since Wi-Fi is a shared medium, this separation ensures slower 802.11a/b/g/n clients do not slow down 802.11ac clients and prevent them from achieving high performance.

### XR-2005 Series 2- and 4-Radio Access Points

These APs include models with one or two Gigabit Ethernet ports and two or four multi-state radios (2.4GHz or 5GHz) that can support 300Mbps or 450Mbps, connecting up to 960 users at one time.

The Riverbed XR-2005 Series Wireless AP has a four slot chassis available in a multi-state (2.4GHz or 5GHz) radio configuration supporting up to 1.8Gbps of bandwidth. These models support a range of low to high-performance applications, including offices, hospitals, campuses and classrooms, and hotels.

Like larger XR APs, these models integrate multi-state radios with high gain directional antennas, an onboard multi-gigabit switch, controller, firewall, threat sensor and spectrum analyzer on a modular chassis designed for extensibility.

Feature	XR-2225	XR-2235	XR-2425	XR-2435
No. radios: 802.11 a/b/g/n/monitor	2	2	4	4
Radio type	2x2	3x3	2x2	3x3
Integrated antennas	4	6	8	12
Integrated wireless switch ports	4	4	4	4
Integrated RF spectrum analyzer, threat sensors	Yes	Yes	Yes	Yes
Gigabit Uplink Ports	2	2	2	2
Wireless bandwidth	600 Mbps	900 Mbps	1.2 Gbps	1.8 Gbps
Users supported	480	480	960	960

XR-2005 Series APs have no console port, but have two Gigabit ports, one of which accepts POE+ power supplied by a Riverbed-supplied power injector or an IEEE802.3at powered switch. Note that older XR-2000 Series APs ending in "0" have one Gigabit POE port and a Console port.

### XR-4006 Series 4- to 8-Radio High Density Access Points

These APs include models with two Gigabit Ethernet ports and four or eight multi-state radios (2.4GHz or 5GHz) supporting 802.11ac and 802.11a/b/g/n. Each of the XR-4836's eight 3x3 802.11ac radios supports 1.3Gbps, connecting up to 1024 users at one time with up to 10.4 Gbps total Wi-Fi bandwidth.

The Riverbed XR-4006 Series Wireless AP has an eight-slot chassis that allows you to purchase a four-radio model and add more radios later as your needs grow. These models support high-performance for high density needs, integrating multi-state radios with high gain directional antennas, an onboard multi-gigabit switch, controller, firewall, threat sensor and spectrum analyzer on a modular chassis designed for extensibility.

A unique feature optimizes wireless performance by automatically segmenting faster 802.11ac clients from slower Wi-Fi clients. Since Wi-Fi is a shared medium, this separation ensures slower 802.11a/b/g/n clients do not slow down 802.11ac clients and prevent them from achieving high performance.

Feature	XR-4426	XR-4436	XR-4826	XR-4836
No. of radios: 802.11 ac/a/b/g/n/monitor	4	4	8	8
Radio type	2x2	3x3	2x2	3x3
Integrated antennas	8	12	16	24
Integrated wireless switch ports	8	8	8	8
Integrated RF spectrum analyzer, threat sensors	Yes	Yes	Yes	Yes
1 Gigabit Uplink Ports	2	2	2	2
Wireless bandwidth	3.5 Gbps	5.2 Gbps	6.9 Gbps	10.4 Gbps
Users supported	512	512	1024	1024

### **XR-4000 Series 4- to 8-Radio High Density APs (not ending in “6”)**

These APs include models with two Gigabit Ethernet ports and four or eight radios (IAPs), connecting up to 1920 users at one time and offering a maximum wireless bandwidth of 3.6 Gbps (up to 450 Mbps per radio). Smaller models may be upgraded to eight radios later when your needs change.

Feature	XR-4420	XR-4430	XR-4820	XR-4830
Number of radios: 802.11a/b/g/n/monitor	4	4	8	8
Radio type	2x2	3x3	2x2	3x3
Integrated antennas	8	12	16	24
Integrated wireless switch ports	8	8	8	8
Integrated RF spectrum analyzer, threat sensors	Yes	Yes	Yes	Yes
1 Gigabit Uplink Ports	2	2	2	2
Wireless bandwidth	1.2 Gbps	1.8 Gbps	2.4 Gbps	3.6 Gbps
Users supported	960	960	1920	1920

### XR-6000 Series 8- to 16-Radio High Density Access Points

These APs include models with four Gigabit Ethernet ports and up to sixteen radios, connecting up to 3840 users at one time and offering a maximum wireless bandwidth of 7.2 Gbps (up to 450 Mbps per radio). Smaller models may be upgraded to sixteen radios later when your needs change. A 10 Gigabit modular Ethernet expansion port (DVI connector) is available to meet high traffic demands. It is used only with an optional Riverbed 10 Gig fiber optics adapter.

Feature	XR-6820	XR-6830	XR-7620	XR-7630
Number of radios: 802.11a/b/g/n/monitor	8	8	16	16
Radio type	2x2	3x3	2x2	3x3
Number of integrated antennas	16	24	32	48
Integrated wireless switch ports	16	16	16	16
Integrated RF spectrum analyzer, threat sensors	Yes	Yes	Yes	Yes
1 Gigabit Uplink Ports	4	4	4	4
External 10 Gigabit Modular Expansion Port	1	1	1	1
Wireless bandwidth (Gbps)	2.4	3.6	4.8	7.2
Users supported	1920	1920	3840	3840

### Enterprise Class Security

The latest and most effective wireless encryption security standards, including Wireless Protected Access (WPA) and WPA2 with 802.11i Advanced Encryption Standard (AES) are available on the Wireless AP. In addition, the use of an embedded RADIUS server (or 802.1x with an external RADIUS server) ensures user authentication—multiple APs can authenticate to the XMS, ensuring only authorized APs become part of the wireless network. With the Riverbed

**Advanced Feature Sets**, intrusion detection and prevention, site monitoring, and RF spectrum analysis are performed in the background by the AP automatically.

### Deployment Flexibility

Riverbed's unique multi-radio architecture (on all APs except the XR-500 Series) generates 360 degrees of sectored high-gain 802.11a/b/g/n coverage that provides extended range and the highest possible data rates for a large volume of clients. Each sector can be adjusted automatically or manually, creating a pattern of wireless coverage perfectly tailored to individual customer needs. For example:

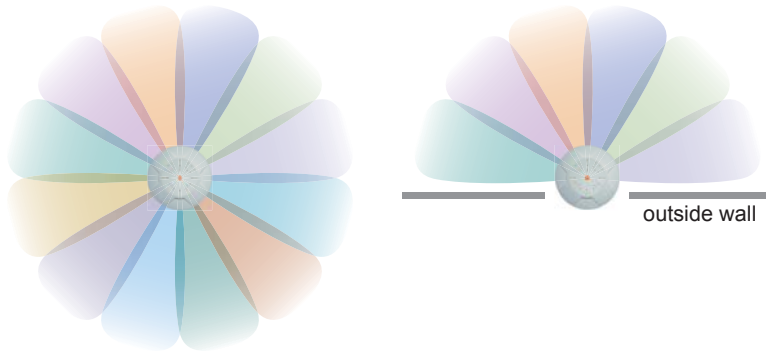

Figure 3. Wireless Coverage Patterns

Figure 3 depicts the following two scenarios:

- **Full pattern coverage**  
All radios are activated with coverage spanning 360 degrees. If within range, clients will always receive coverage regardless of their geographic position relative to the AP. Radios may be assigned to 2.4 GHz and/or 5.0 GHz bands in any desired pattern.
- **Partial pattern coverage**  
If desired, the Wireless AP can be deployed close to an exterior wall. In this case, half of all available radios have been deactivated to prevent redundant signals from “bleeding” beyond the site’s perimeter wall. This configuration may also be used in those cases where you want to restrict wireless coverage to selected areas of the building’s interior.

### Power over Ethernet (PoE)

Some smaller APs (XR-2000 models ending in “5” or “6”, and XR-500/600 Series) are compatible with IEEE802.3af and/or IEEE802.3at PoE+, and may be connected to appropriate powered switches. For example, the Riverbed XT-5024 and XT-5048 are 24-and 48-port 802.3at POE+ managed switches. See the Installation Guide for the AP for compatible injectors or powered switches.

PoE modules provide power to APs over the same Cat 5e or Cat 6 cable used for data. Managed modules provide the ability to control power using XMS.

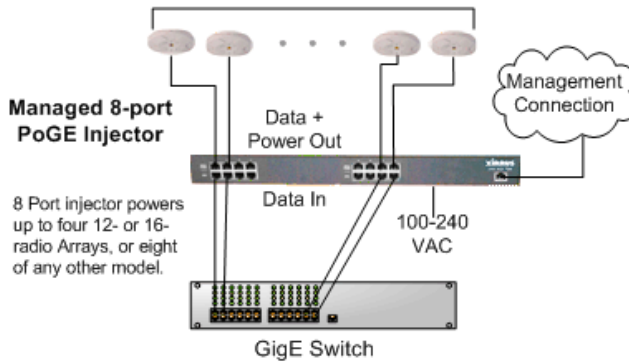

Figure 4. XP8 - Power over Ethernet Usage

Specific models of the AP are compatible with specific PoE modules.

### Enterprise Class Management

The Wireless AP can be used with its default settings, or it can be initially configured using zero touch cloud-based automated provisioning. Settings may also be customized using the AP’s embedded WMI. The WMI enables easy



## Wireless Access Point

configuration and control from a graphical console, plus a full complement of troubleshooting tools and statistics.

Xirrus XR630 WiFi Arra  
factoryap (192.168.1.84) Anywhere, US  
Uptime: 0 days, 1 hours, 2 min  
Logged in as: admin  
Operating Status Information Loaded

### Ethernet Settings Summary

Interface	State	Management	LED	Auto Neg	Link	Duplex	Speed (Mbps)	MTU Size	DHCP	IP Address	Subnet Mask	Gateway
gig1	enabled	enabled	enabled	on	up	full	1000	1500	enabled	192.168.1.84	255.255.255.0	192.168.1.254
gig2	enabled	enabled	enabled	on	down	full	10	1500	enabled	192.168.1.84	255.255.255.0	192.168.1.254

### Bond Settings Summary

Interface	Bond	Mode	Ports	Active VLANs	Mirror
gig1	bond1	link-backup	gig1 gig2	all	off
gig2	bond1	link-backup	gig1 gig2	all	off

### IAP Summary

IAP	State	AP Type	Band	WiFi Mode	Bond	Channels	Channel Mode	Antenna	Cell Size	TX Power	RX Threshold	Stations	Distance	BSSID
iap1	up	.11abgnac 3...	2.4GHz	bgn	off	1	manual	interna...	max	20	-90	0		50:60:28:22:ce:a0-a2
iap2	up	.11abgnac 3...	5GHz	anac	40mhz...	157.161	autom...	interna...	max	20	-90	0		50:60:28:22:ce:b0-b2

### Network Assurances

Setting	Hostname	IP Address	Status
---------	----------	------------	--------

Figure 5. WMI: AP Status

In addition, a fully featured Command Line Interface (CLI) offers IT professionals a familiar management and control environment. Simple Network Management Protocol (SNMP) is also supported to allow management from an SNMP compliant management tool, such as the optional XMS.



*For deployments of more than five APs, we recommend that you use the cloud-based or enterprise version of XMS. XMS offers a rich set of features for fine control over large deployments.*

## Key Features and Benefits

This section describes some of the key product features and the benefits you can expect when deploying the Wireless AP (the XR-7630 product is used as an example in this section).

Riverbed Wireless APs enable wireless connectivity and easily handle time-sensitive traffic such as voice. A maximum wireless capacity of 13.88 Gbps offers ample reserves for the high demands of current and future applications.

Security is provided by RF monitoring and intrusion detection/prevention mode.

## Extended Coverage

Specially-designed integrated directional antennas provide increased wireless range and enhanced data rates in all directions. With a Wireless AP deployed, far fewer access points are needed and wired-like resiliency is delivered throughout your wireless network. Your Wireless AP deployment ensures:

- Continuous connectivity if an IAP (radio) fails.
- Continuous connectivity if an AP fails.
- Continuous connectivity if a WDS link or switch fails.
- Continuous connectivity if a Gigabit uplink or switch fails.

## Flexible Coverage Schemes

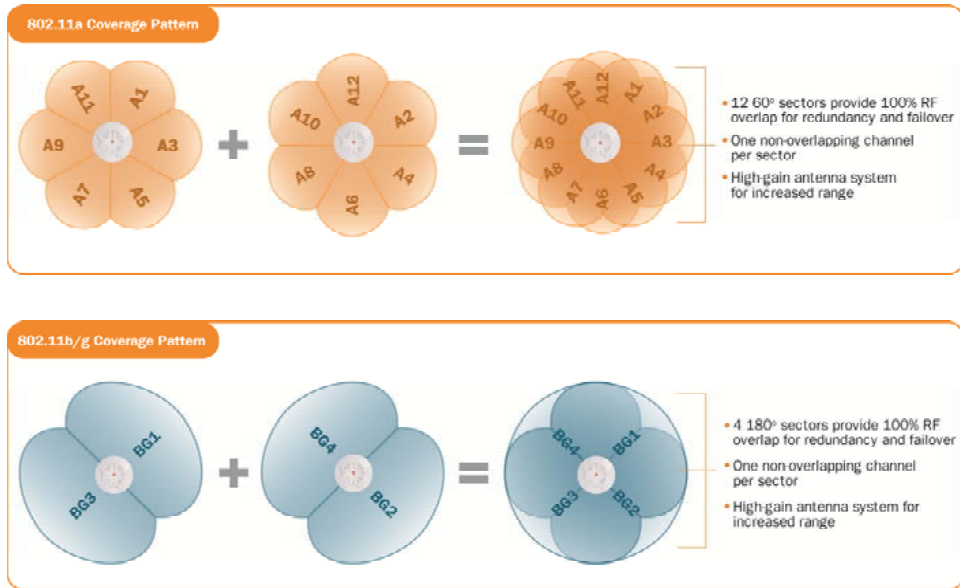

Figure 6. Coverage Schemes (XR-7230 shown)

- **802.11ac, 11a/n**  
Delivers 60° wireless coverage per IAP, with 6 dBi of gain.
- **802.11b/g/n**  
Delivers 180° wireless coverage, with 3 dBi of gain.
- **802.11a/b/g/n (monitor only)**  
Delivers 360° wireless coverage, with 2 dBi of gain.

### Non-Overlapping Channels

Complete use of non-overlapping channels limits interference and delivers maximum capacity across the 5GHz and 2.4GHz spectrums.

### **SDMA Optimization**

SDMA (Spatial Division Multiple Access) technology provides full 360° coverage while allowing independent channel and power output customization. Also supports fast inter-zone handoffs for time-sensitive applications and roaming.

### **Fast Roaming**

Fast roaming utilizes the Riverbed Roaming Protocol ensuring fast and seamless roaming capabilities between IAPs or APs at both Layer 2 and Layer 3.

### **Ease of Deployment**

Riverbed XMS simplifies and speeds deployment of the wireless network by automatically setting up each AP's license, software image, and initial configuration. When the AP is installed and has Internet connectivity, it contacts Riverbed, which performs these initialization tasks.

### **Powerful Management**

The XMS offers real time monitoring and management capabilities for the wireless network.

### **Secure Wireless Access**

Multiple layers of authentication and encryption ensure secure data transmissions. The Wireless AP is 802.11i compliant with line-rate encryption support for 40 and 128 bit WEP, WPA and WPA2 with TKIP and AES encryption. Authentication is provided via 802.1x, including PEAP, EAP-TLS, EAP-TTLS, EAP-SIM, EAP-GTC, EAP-AKA, EAP-AKA-Prime, and Lightweight Extensible Authentication Protocol (LEAP) passthrough. Intrusion detection and prevention provide proactive monitoring of the environment for threats.

### **Applications Enablement**

The Wireless AP's Quality of Service (QoS) functionality combined with true switch capabilities enable high density video and Voice over Wireless LAN deployments. Compliant with 802.1p and 802.1Q standards.

*See Also*

[Wireless Access Point Product Overview](#)

## Advanced Feature Sets

The Wireless AP offers a family of powerful functionality packages, including the RF Performance Manager (RPM), RF Security Manager (RSM), RF Analysis Manager (RAM), and Application Control. These four packages are separately licensed for operation on your AP. RPM, RSM, and RAM are automatically included as part of all APs. Application Control is an optional feature.

### Riverbed Advanced RF Performance Manager (RPM)

The Riverbed RPM optimizes the bandwidth usage and station performance of wireless networks. Leveraging the multiple integrated access point (multi-radio) design of the Riverbed Wireless AP, RPM manages the allocation of wireless bandwidth to wireless stations across multiple RF channels. The result maximizes overall network performance with superior flexibility and capacity.

Today's wireless infrastructure is faced with ever increasing numbers and variations of wireless enabled clients, whether in the form of notebooks, tablets, smart phones, IP phones, printers, projectors, cameras, RFID tags, etc. The advent of higher speed wireless and its increased use of the 5GHz spectrum adds to the number of variables today's wireless networks must accommodate. Backwards compatibility with older clients is crucial, however their operation in a wireless network can significantly hinder the performance of faster clients. As an example, 802.11b wireless stations communicate more than 10 times slower than 802.11n stations.

With each of the AP's multiple radios operating on a different channel, RPM selects the ideal radio for each station. High-speed stations are grouped together on radios with other high speed stations, while lower speed stations are combined with other lower speed stations. This ensures optimal performance for high-speed 802.11ac stations without compromise.

The complete feature set of the RPM package includes:

- Wireless Distribution System (WDS) for point-to-point communication

- Wireless Mode per IAP
- Sharp Cell technology
- Wireless Data Rate Optimization
- Wireless Traffic Shaping
- Wireless Voice Call Admission Control
- Fast Layer 2 and 3 Roaming
- Standby Mode

### Riverbed Advanced RF Security Manager (RSM)

The Riverbed RSM improves security and minimizes the risk in deploying 802.11 wireless networks. Leveraging an integrated 24/7 threat sensor and hardware-based encryption/decryption in each AP, RSM secures the wireless network from multiple types of threats. The result delivers uncompromised overall network security with superior flexibility and performance.

Wireless networks face a number of potential security threats in the form of rogue access points, ad-hoc clients, unauthorized clients, wireless-based attacks, eavesdropping, etc. As “bring your own device” (BYOD) becomes ubiquitous in enterprise networks, defending against these threats becomes more critical. With the AP’s threat sensor radio scanning all channels in the 2.4GHz and 5GHz spectrums, RSM searches for security threats and automatically mitigates them.

High performance encryption/decryption in the enterprise wireless network is a must. The wireless network needs to support each client using the highest level of encryption (WPA2 Enterprise/128 bit AES) and without degrading the overall performance of the network. Riverbed incorporates hardware-based encryption/decryption into each AP, delivering line-rate encryption at the edge of the network instead of at a choke point within a centralized controller.

The complete feature set of the RSM package includes:

- Wireless IDS/IPS (Intrusion Detection/Prevention System)
- Wireless stateful firewall
- User group policies
- Authenticated guest access gateway

- NAC integration

### Riverbed Advanced RF Analysis Manager (RAM)

The RF Advanced Analysis Manager (RAM) tests and troubleshoots wireless networks. The deployment of 802.11ac presents a set of unique challenges based on technology differences with legacy 802.11a/b/g/n networks, both on the wireless infrastructure and client side. Riverbed RAM equips each Wireless AP with a powerful set of tools and features to optimally tune and verify an 802.11ac installation, as well as give IT administrators the ability to troubleshoot issues that may occur within the wireless environment.

802.11ac deployment will continue to evolve over the next several years with additional performance and optional functions, along with an ongoing stream of IEEE 802.11 amendments. This changing wireless landscape mandates that appropriate tools are available to the user to analyze, optimize, and troubleshoot their changing environments.

The distributed architecture of the AP enables the execution of powerful wireless and networking analysis at the edge of the network where packets traverse the wireless-to-wired boundary. The AP includes an embedded wireless controller with the necessary computing and memory resources to provide these functions securely at the network's edge.

The key elements of the RAM package include:

- RF Analysis – An embedded Spectrum Analyzer leverages the dedicated threat sensor radio in each Wireless AP to provide a continual view of utilization, interference, and errors across all available wireless channels.
- Packet Analysis – Integrated packet capture provides filterable views of all traffic traversing on the wired and wireless interfaces of the AP.
- Performance Analysis – Embedded traffic generation enables the throughput of the AP's wireless or wired interfaces to be analyzed.
- Failure Recovery – Radio Assurance provides an automatic self-test and self healing mechanism that ensures continuous system operation.
- Netflow Support
- Network Tools: ping, RADIUS ping, traceroute

## Riverbed Application Control

The Application Control feature is available on APs to provide real-time visibility of application usage by users across the wireless network. Network usage has changed enormously in the last few years, with the increase in smart phone and tablet usage stressing networks.

The AP uses Deep Packet Inspection (DPI) to determine what applications are being used and by whom, and how much bandwidth they are consuming. These applications are rated by their degree of risk and productiveness. The results are presented to you both graphically and in tables. [Filters](#) can be used to implement per-application policies that keep network usage focused on productive uses, eliminating risky and non-business-oriented applications such as BitTorrent. You can increase the priority of mission-critical applications like VoIP and WebEx. See “Application Control Windows” on page 154 for more information.

## About this User’s Guide

This User’s Guide provides detailed information and procedures that will enable wireless network administrators to install, configure and manage the Wireless AP so that end users can take full advantage of the product’s features and functionality without technical assistance.

## Organization

Topics and procedures are organized by function under the following chapter headings:

- **Introduction**  
Provides a brief introduction to wireless technology, an overview of the product, including its key features and benefits, and presents the product specifications.
- **Installing the Wireless AP**  
Defines prerequisites for deploying and installing the AP and provides instructions to help you plan and complete a successful installation.



- **The Windows Management Interface**

Offers an overview of the product's embedded Windows Management Interface, including its content and structure. It emphasizes what you need to do to ensure that any configuration changes you make are applied, and provides a list of restricted characters. It also includes instructions for logging in to the AP with your Web browser.
- **Viewing Status on the Wireless AP**

Describes the status and statistics displays available on the AP using its embedded Windows Management Interface.
- **Configuring the Wireless AP**

Contains procedures for configuring the AP using its embedded Windows Management Interface.
- **Using Tools on the Wireless AP**

Contains procedures for using utility tools provided in the Windows Management Interface. It includes procedures for upgrading the system firmware, uploading and downloading configurations and other files, using diagnostic tools, and resetting the AP to its factory defaults.
- **The Command Line Interface**

Includes the commands and the command structure used by the Wireless AP's Command Line Interface (CLI), and provides a procedure for establishing a Telnet connection to the AP. This chapter also includes some sample key configuration tasks using the CLI.
- **Appendix A: Quick Reference Guide**

Contains the product's factory default settings.
- **Appendix B: FAQ and Special Topics**

Offers guidance to resolve technical issues, including general hints and tips to enhance your product experience, and a procedure for isolating problems within an AP-enabled wireless network. Also includes Frequently Asked Questions (FAQs) and Riverbed contact information.

- **Appendix C: Notices (XA, XD and XR500/600 Series Only)**

Contains the legal notices and compliance statements for the XD and XR500 Series Access Points. Please read this section carefully if you are using these models.
- **Appendix D: Notices (XR-1000 to XR-6000 Indoor Models)**

Contains the legal notices and compliance statements for the AP. Please read this section carefully.
- **Appendix E: Medical Usage Notices**

Provides compliance information for Riverbed devices with respect to the requirements of IEC 60601-1-2.
- **Appendix F: Auditing PCI DSS**

Discusses using AP features to assist in meeting security standards for PCI DSS audits.
- **Appendix G: Implementing FIPS Security**

Discusses meeting FIPS security standards with Riverbed devices.
- **Glossary of Terms**

Provides an explanation of terms directly related to Riverbed product technology, organized alphabetically.
- **Index**

The index is a valuable information search tool. Use the index to locate specific topics discussed in this User's Guide. Simply click on any page number in the index to jump to the referenced topic.

## Notes and Cautions

The following symbols are used throughout this User's Guide:



*This symbol is used for general notes that provide useful supplemental information.*



*This symbol is used for cautions. Cautions provide critical information that may adversely affect the performance of the product.*

### Screen Images

Some screen images of the Windows Management Interface have been modified for clarity. For example, an image may have been cropped to highlight a specific area of the screen, and/or sample data may be included in some fields.

### Product Specifications

Please refer to the Riverbed web site for the latest specifications for these APs—[www.riverbed.com](http://www.riverbed.com).



# Installing the Wireless AP

The instructions for planning and completing a successful installation include the following topics:

- [“Installation Prerequisites” on page 33.](#)
- [“Planning Your Installation” on page 36.](#)
- [“Installation Workflow” on page 71.](#)
- [“Installing Your Wireless AP” on page 73.](#)
- [“Powering Up the Wireless AP” on page 76.](#)
- [“Zero-Touch Provisioning and Ongoing Management” on page 79.](#)
- [“Performing the Express Setup Procedure” on page 84.](#)

## Installation Prerequisites

Wireless AP deployment requires the presence of hardware and services in the host wired/wireless network, including:

- **Power Source**

Riverbed APs are powered via Riverbed-supplied Power over Ethernet. PoE supplies power over the same Cat 5e or Cat 6 cable used for data, thus reducing cabling and installation effort. PoE power injector modules are available in 1-, 2-, and 8-port configurations and are typically placed near your Gigabit Ethernet switch. An AC outlet is required for each injector module.

Some smaller APs are compatible with IEEE802.3af and/or IEEE802.3at, and may be connected to appropriate powered switches. For example, the Riverbed XT-5024 is a 24-port 802.3at PoE+ managed switch. See the Installation Guide for the AP for compatible injectors or powered switches.
- **Ethernet ports**

You need at least one 100/1000 BaseT port to establish wired Gigabit Ethernet connectivity. XR Series APs have different numbers of ports,

depending on the model (see “XR Wireless AP Product Family” on page 10).

! *The AP’s Ethernet ports should be connected to an Ethernet switch, not an Ethernet hub—if a hub is used, we recommend that you do not bond-pair Ethernet ports.*

- **Secure Shell (SSH) utility**

To establish secure remote command line access to the AP, you need a Secure Shell (SSH) utility, such as PuTTY. The utility **must** be configured to use SSH-2, since the AP will only allow SSH-2 connections.

- **Secure Web browser**

Riverbed supports the latest version of the following Browsers: Internet Explorer, Mozilla Firefox, Chrome, or Safari. A secure Web browser is required for Web-based management of the AP. The browser must be on the same subnet as the AP, or you must set a static route for management as described in the warning above.

- **Serial connection capability**

A serial port (console) is present on most XR-2000 models and all larger XR series models. The Xircon utility can be used in place of a console port—see the Xircon *User’s Guide*. To connect directly to the console port on the AP, your computer must be equipped with a male 9-pin serial port and terminal emulation software (for example, HyperTerminal). The Riverbed AP only supports serial cable lengths up to 25’ per the RS-232 specification.

Use the following settings when establishing a serial connection:

Bits per second	115,200
Data bits	8
Parity	None
Stop bits	1
Flow control	None

### Optional Network Components

The following network components are optional.

- **Xirrus Management System (XMS)**  
The optional XMS offers powerful management features for small or large Wireless AP deployments.

### Client Requirements

The Wireless AP should only be used with Wi-Fi certified client devices.

#### *See Also*

[Coverage and Capacity Planning](#)

[Failover Planning](#)

[Planning Your Installation](#)

---

## Planning Your Installation

This section provides guidelines and examples to help you plan your Riverbed Wireless AP deployment to achieve the best overall coverage and performance. We recommend you conduct a site survey to determine the best location and settings for each AP you install.

- [“General Deployment Considerations” on page 36](#)
- [“Coverage and Capacity Planning” on page 38](#)
- [“About IEEE 802.11ac” on page 46](#)
- [“Failover Planning” on page 56](#)
- [“Power Planning” on page 59](#)
- [“Security Planning” on page 60](#)
- [“Port Requirements” on page 62](#)
- [“Network Management Planning” on page 66](#)
- [“WDS Planning” on page 67](#)
- [“Common Deployment Options” on page 70](#)

### General Deployment Considerations



*For optimal placement of APs, we recommend that a site survey be performed by a qualified Riverbed partner.*

The Riverbed AP's unique multi-radio architecture generates 360 degrees of sectored high-gain 802.11a/b/g/n/ac coverage that provides extended range. (Note that XR-500/600 Series radios are omni-directional rather than sectored.) The number, thickness and location of walls, ceilings or other objects that the wireless signals must pass through may affect the range. Typical ranges vary depending on the types of materials and background RF (radio frequency) noise at your location. To maximize wireless range, follow these basic guidelines:

1. Keep the number of walls and ceilings between the AP and your receiving devices to a minimum—each wall or ceiling can reduce the wireless range from between 3 and 90 feet (1 to 30 meters). Position your devices so that the number of walls or ceilings is minimized.



2. Be aware of the direct line between each device. For example, a wall that is 1.5 feet thick (half a meter) at  $90^\circ$  is actually almost 3 feet thick (or 1 meter) when viewed at a  $45^\circ$  angle. At an acute  $2^\circ$  degree angle the same wall is over 42 feet (or 14 meters) thick. For best reception, try to ensure that your wireless devices are positioned so that signals will travel straight through a wall or ceiling.

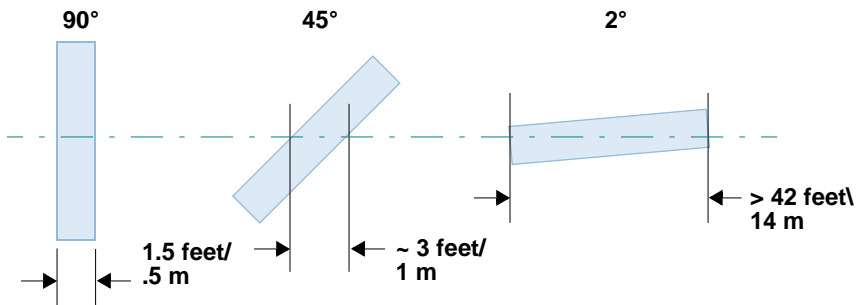

Figure 7. Wall Thickness Considerations

3. Try to position wireless client devices so that the signal passes through drywall (between studs) or open doorways and not other materials that can adversely affect the wireless signal.

### *See Also*

[Coverage and Capacity Planning](#)

[Common Deployment Options](#)

[Installation Prerequisites](#)

## Coverage and Capacity Planning

This section considers coverage and capacity for your deployment(s), including placement options, RF patterns and cell sizes, area calculations, roaming considerations, and channel allocations.



*XR-500/600 Series Integrated Access Points are omni-directional rather than directional (sectored), and discussions involving sectored radios are not applicable to these APs.*

### Placement

Use the following guidelines when considering placement options:

1. The best placement option for the AP is ceiling-mounted within an open plan environment (cubicles rather than fixed walls).
2. Keep the AP away from electrical devices or appliances that generate RF noise. Because the AP is generally mounted on ceilings, be aware of its position relative to lighting (especially fluorescent lighting)—we recommend maintaining a distance of at least 3 to 6 feet (1 to 2 meters).

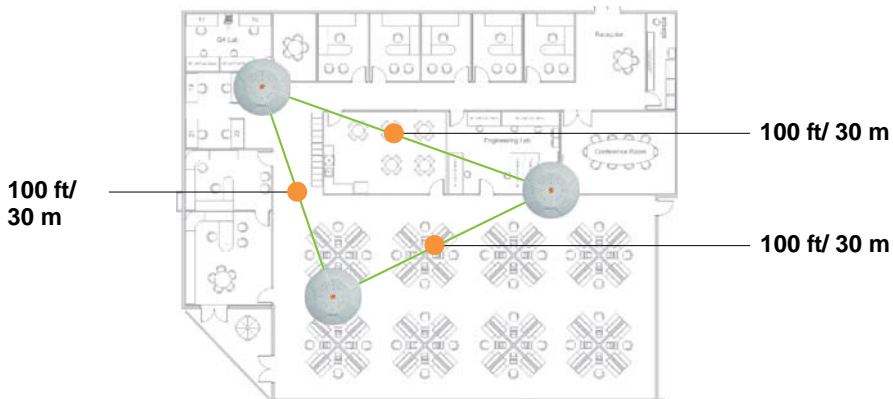

Figure 8. Unit Placement

3. If using multiple APs in the same area, maintain a distance of at least 100ft/30m between APs if there is direct line-of-sight between units, or at least 50ft/15m if a wall or other barrier exists between units.

### RF Patterns

The Wireless AP allows you to control—automatically or manually—the pattern of wireless coverage that best suits your deployment needs. You can choose to operate with full coverage, half coverage, or custom coverage (by enabling or disabling individual sectors).

#### *Full (Normal) Coverage*

In normal operation, the AP provides a full 360 degrees of coverage.

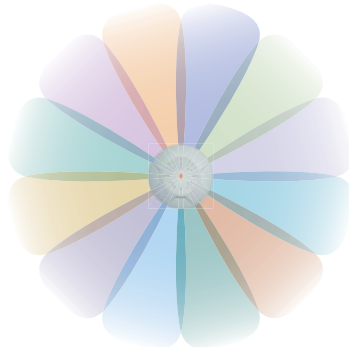

Figure 9. Full (Normal) Coverage

#### *Half Coverage*

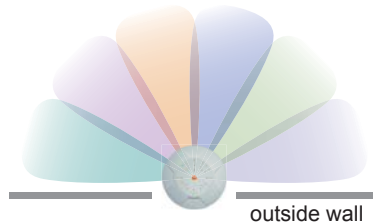

Figure 10. Adjusting RF Patterns

If installing a unit close to an exterior wall, you can deactivate half of the radios to prevent redundant signals from “bleeding” beyond the wall and extending service into public areas. The same principle applies if you want to restrict service to an adjacent room within the site.

### Custom Coverage

Where there are highly reflective objects in proximity to the AP, you can turn off specific radios to avoid interference and feedback.

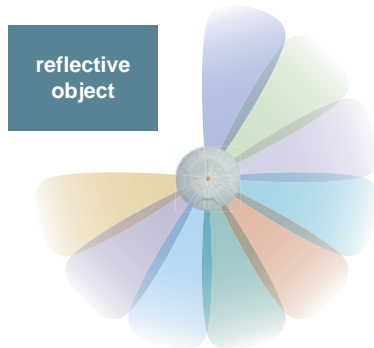

Figure 11. Custom Coverage

### Capacity and Cell Sizes

Cell sizes should be estimated based on the number of users, the applications being used (for example, data/video/voice), and the number of APs available at the location. The capacity of a cell is defined as the minimum data rate desired for each sector multiplied by the total number of sectors being used.



Figure 12. Connection Rate vs. Distance

Figure 12 shows relative connection rates for 802.11n vs. 802.11a/g and 802.11b, and the effect of distance on the connection rates. 802.11ac rates behave like 802.11n over distance—see Figure 22 for 802.11ac data rates). Wireless environments can vary greatly so the actual rates may be different depending on the specific network deployment.

### Fine Tuning Cell Sizes

Adjusting the [transmit power](#) allows you to fine tune cell sizes. There are four standard sizes—Small, Medium, Large, or Max (the default is **Max**). There is also an Auto setting that automatically determines the best cell size, and a Manual setting that allows you to choose your power settings directly.

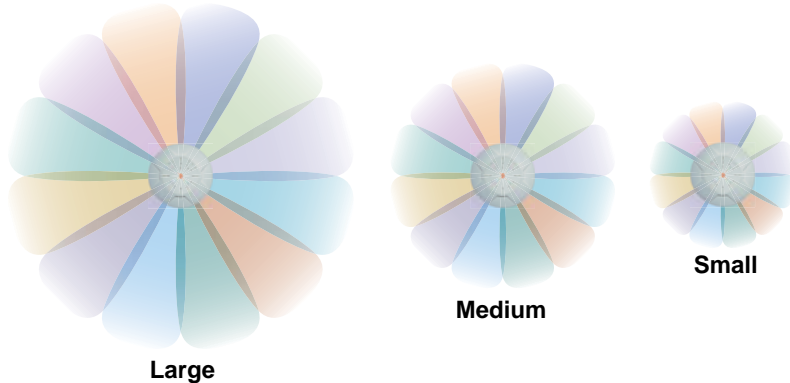

Figure 13. Transmit Power

Auto Cell Size is an automatic, self-tuning mechanism that balances cell size between APs to guarantee coverage while limiting the RF energy that could extend beyond the organizational boundary. Auto Cell uses communication between APs to dynamically set radio power so that complete coverage is provided to all areas, yet at the minimum power level required. This helps to minimize potential interference with neighboring networks. Additionally, APs running Auto Cell automatically detect and compensate for coverage gaps caused by system interruptions. To enable the Auto Cell Size feature, go to [“RF Power and Sensitivity” on page 367](#).

There are two ways of performing Auto Cell Size—by band (Multichannel Auto Cell) or by channel (this is the default version). Auto Cell by channel adjusts the size of two or more neighboring AP radios that are on the same channel ([Figure 14 A and B](#)). Multichannel Auto Cell adjusts cell sizes of neighboring radios on the same band (2.4GHz or 5GHz) even if they are on different channels. A potential application of Auto Cell by Band is depicted in [Figure 14 B and C](#). In this example,

cell sizes are to be adjusted so that they are contained in each room. The goal is for stations to associate to the AP located in the same room with them.

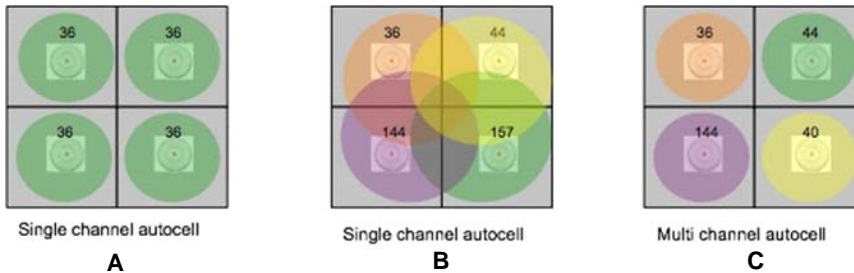

Figure 14. Auto Cell Size Options

Multichannel Auto Cell is configured by turning off **Auto Cell by Channel** in “[Procedure for Configuring Global 802.11an IAP Settings](#)” on page 341 for the 5GHz band, and in “[Procedure for Configuring Global 802.11b/g IAP Settings](#)” on page 348 for the 2.4GHz band. Note that Multichannel Auto Cell is run separately for each band. Thus, to optimize cell size of both 2.4G and 5G, the Auto Cell function should be run once for each of these pages. APs **must** be at least 15 feet apart for Auto Cell to work properly.

If you are installing many units in proximity to each other, we recommend that you use Auto Cell Size; otherwise, reduce the transmit power using manual settings to avoid excessive interference with other APs or installed APs. See also, “[Coverage and Capacity Planning](#)” on page 38.

### *Sharp Cell*

This patented Riverbed RF management option automatically creates more intelligently defined cells and improves performance by creating smaller, high-throughput cells. By dynamically limiting each cell to a defined boundary (cell size), the trailing edge bleed of RF energy is reduced, thus minimizing interference between neighboring Wireless APs or other Access Points. To enable the Sharp Cell feature, go to “[RF Power and Sensitivity](#)” on page 367.

### Roaming Considerations

Cells should overlap approximately 10 - 15% to accommodate client roaming.

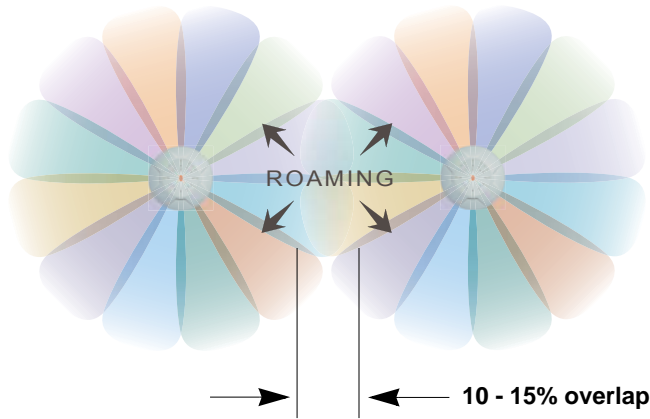

Figure 15. Overlapping Cells

### Allocating Channels

Because the Wireless AP is a multi-channel device, allocating the best channels to radios is important if peak performance is to be maintained.



*Note that Auto Channel normally assigns individual channels. However, if you select **Auto bond 5GHz channels** for 11n or 11ac global settings, and have 40MHz or 80MHz bonds set up prior to running Auto Channel, those bonds will be preserved.*

### Automatic Channel Selection

In the automatic mode, channels are allocated dynamically, driven by changes in the environment. Auto Channel assignment is performed by scanning the surrounding area for RF activity on all channels, then automatically selecting and setting channels on the AP to the best channels available. This function is typically executed when initially installing APs in a new location and may optionally be configured to execute periodically to account for changes in the RF environment over time. Auto Channel selection has significant advantages, including:

- Allows the AP to come up for the first time and not interfere with existing equipment that may be already running, thereby limiting co-channel interference.
- More accurately tunes the RF characteristics of a wireless installation than manual configuration since the radios themselves are scanning the environment from their physical location.
- May be configured to run periodically.

To set up the automatic channel selection feature, go to “[Advanced RF Settings](#)” on page 364.

### *Manual Channel Selection*

You can manually assign channels on a per radio basis, though manual selection is not recommended (and not necessary).



*To avoid co-channel interference, do not select adjacent channels for radios that are physically next to each other.*

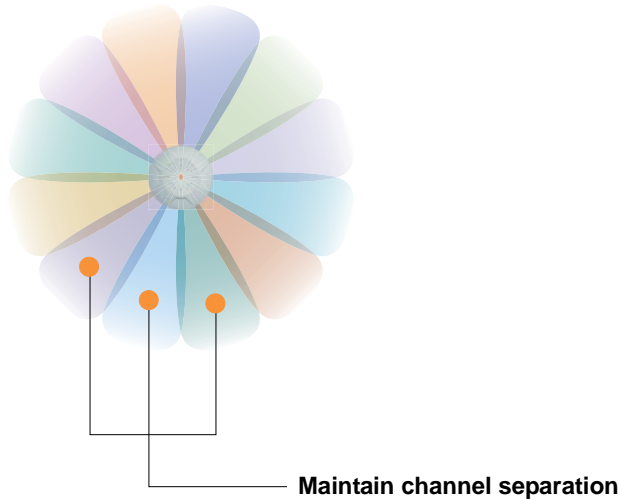

Figure 16. Allocating Channels Manually



### **Other Factors Affecting Throughput**

Throughput of the AP can be affected by many factors such as distance, number of stations, obstacles, construction materials used at the site, etc. In addition, features applied to traffic may have an effect. Performance may decrease as you add increasing numbers of SSIDs, VLANs, and features such as [Application Control](#), encryption, management via XMS-Cloud, etc. XR-500/1000 Series models are more prone to performance degradation since they have less memory than other models.

#### *See Also*

[Failover Planning](#)

[Installation Prerequisites](#)

### About IEEE 802.11ac

802.11ac is a continuation of the IEEE 802.11 standard. It multiplies the maximum data rate—eventually, up to ten times the 802.11n maximum. Along with increased data rates, it offers simultaneous transmission to multiple clients.

802.11ac is being rolled out in two phases. Wave 1 products currently available support 80MHz channels and up to 3 data streams for a maximum data rate of 1.3 Gbps. Wave 2 and future products will add 160MHz channels and up to 8 streams, for a maximum data rate of 6.93Gbps.

Riverbed currently supports up to four streams (in units with 4x4 radios) and 160 bonded channels. Riverbed models that offer 802.11ac support this technology on all radios, not just on one. Radios are individually configurable to different modes or groups of modes (such as 802.11a, 11b, 11g, and 11n). Riverbed optimizes 802.11ac performance with ACEXpress™, an innovation that intelligently separates fast and slow devices on separate radios to maximize system performance.

The major advantages of 802.11ac are:

- Faster speeds than 802.11n over the same coverage area, operating at up to 1.3 Gbps in Wave 1 and up to 1.733 Gbps in Wave 2. While the maximum distance that a Wi-Fi signal can reach is unchanged with 802.11ac, multiple antennas increase the data rate at every distance.
- Operates only in the less congested 5 GHz spectrum, which offers “cleaner” air and supports much greater capacity than the 2.4 GHz spectrum still used by 802.11n.
- Supports simultaneous communications to multiple clients on a single channel with multi-user MIMO in Wave 2.
- Extends the techniques pioneered in 802.11n: more antennas, more spatial streams and wider channels to improve throughput.

The techniques that 802.11ac uses to realize these performance improvements and the expected results are discussed in:

- **“Up to Eight Simultaneous Data Streams—Spatial Multiplexing” on page 48**

- [“MIMO \(Multiple-In Multiple-Out\)” on page 48](#)
- [“MU-MIMO \(Multi-User Multiple-In Multiple-Out\)” on page 49](#)
- [“Higher Precision in the Physical Layer” on page 51](#)
- [“Higher Channel Widths \(Bonding\)” on page 52](#)
- [“802.11ac Data Rates” on page 53](#)
- [“ACExpress™” on page 54](#)

It is important to consider [Higher Channel Widths \(Bonding\)](#) when planning your deployment, since it contributes greatly to 802.11ac’s speed improvements and because it is configured separately for each radio. Your selection of channel width in [IAP Settings](#)—40MHz, 80MHz, or 20MHz (if bonding is turned off)—has a major effect on your channel planning. A global setting is provided to enable or disable 802.11ac mode. See [“Global Settings .11ac” on page 356](#) to configure operation.

There are other factors to keep in mind when planning a roll-out of 802.11ac. Please see [“802.11ac Deployment Considerations” on page 54](#).

### Up to Eight Simultaneous Data Streams—Spatial Multiplexing

Spatial Multiplexing transmits completely separate data streams on different antennas (in the same channel) that are recombined to produce new 802.11ac data rates. Previously used for 802.11n, the maximum number of streams for 802.11ac has been increased to eight. Higher data rates are achieved by splitting the original data stream into separate data streams. Each separate stream is transmitted on a different antenna (using its own RF chain). MIMO signal processing at the receiver can detect and recover each stream. Streams are then recombined, yielding higher data rates.

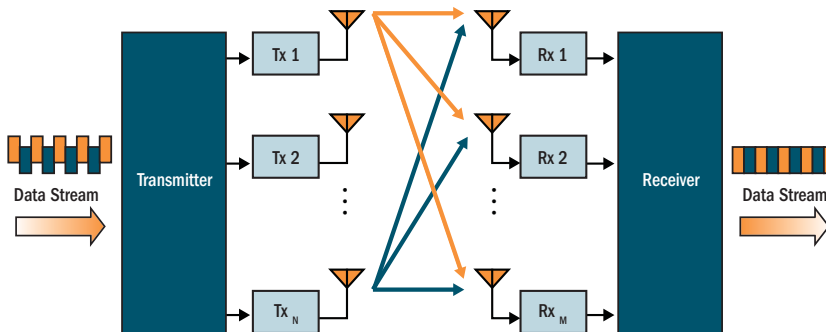

Figure 17. Spatial Multiplexing

The data rate increases directly with the number of transmit antennas used. Note that mobile devices in the near future will support up to three or four streams at most, with many supporting less.

### MIMO (Multiple-In Multiple-Out)

MIMO (Multiple-In Multiple-Out) signal processing is one of the core technologies of 802.11n and 802.11ac. It mitigates interference and maintains broadband performance even with weak signals.

Prior to 802.11n, a data stream was transmitted via one antenna. At the receiving end, the antenna with the best signal was selected to receive data. MIMO signal processing uses multiple antennas to send and receive data. It takes advantage of multipath reflections to improve signal coherence and greatly increase receiver sensitivity (Figure 18). Multipath signals were considered to be interference by

802.11a/b/g radios, and degraded performance. In 802.11n and 802.11ac, these signals are used to enhance performance.

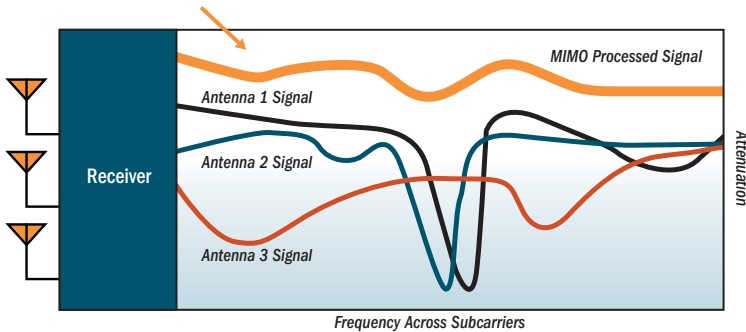

Figure 18. MIMO Signal Processing

802.11ac increases the number of antennas and spatial streams from a maximum of four in 802.11n to a maximum of eight, contributing to much higher maximum data rates (up to 6.93Gbit/s). The spatial streams can be concurrently allocated to more than one receiving device when the AP operates in multi-user MIMO mode (MU-MIMO, see the next section).

### MU-MIMO (Multi-User Multiple-In Multiple-Out)

MU-MIMO (multi-user multiple-in/multiple-out) signal processing uses multiple antennas on the transmitter and receiver operating on the same channel. With spatial multiplexing in 802.11ac, up to 8 data streams may be concurrently transmitted. MU-MIMO's innovation allows the streams to be split between multiple devices at once.

With 802.11n, whenever the IAP transmitted data, all of the traffic at any instant of time was directed to a single client. As a consequence, if a set of devices included a mix of fast and slow client clients, the fast traffic was often substantially delayed by the transmission to slower clients. 802.11ac MU-MIMO works by directing some of the spatial streams to one client and other spatial streams to other clients, up to four at a time

For example, in the figure below, the transmitter has four antennas. Three are transmitting to an 802.11ac laptop that has three antennas, while the remaining

one is directed to a mobile phone. When a transmission is complete, the antennas are reallocated.

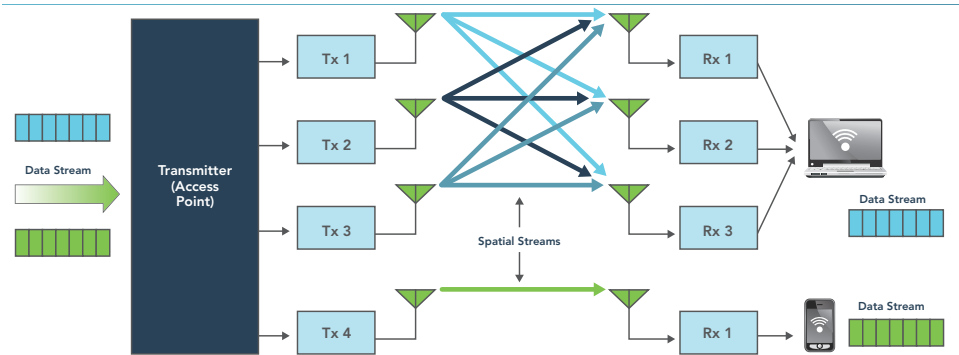

Figure 19. MU-MIMO with Four Antennas

The table below illustrates how data streams might be allocated to multiple users on an 802.11ac transmitter with multiple antennas.

# of AP Antennas	Possible Combinations of Receiver Antennas
2	1 station w/ 2 antennas -or- 2 stations w/ 1 antenna
3	1 station w/ 3 antennas -or- 1 station w/ 2 antennas + 1 station w/ 1 antenna -or- 3 stations w/ 1 antenna
4	1 station w/4 antennas -or- 2 stations w/2 antennas -or- 1 station w/2 antennas + 2 stations w/1 antenna -or- 4 stations w/ 1 antenna
8	1 station w/ 8 antennas -or- 2 stations w/ 4 antennas -or- 1 station w/ 4 antennas + 2 stations w/ 2 antennas -or- 2 stations w/ 2 antennas + 4 stations w/1 antenna -or- ... many other combinations ...

### Higher Precision in the Physical Layer

Wi-Fi utilizes several digital modulation techniques and automatically switches between them to optimize for throughput or range. The basic unit of data transmitted is called a symbol. The number of points in the modulation constellation determines the number of bits of data conveyed with each symbol.

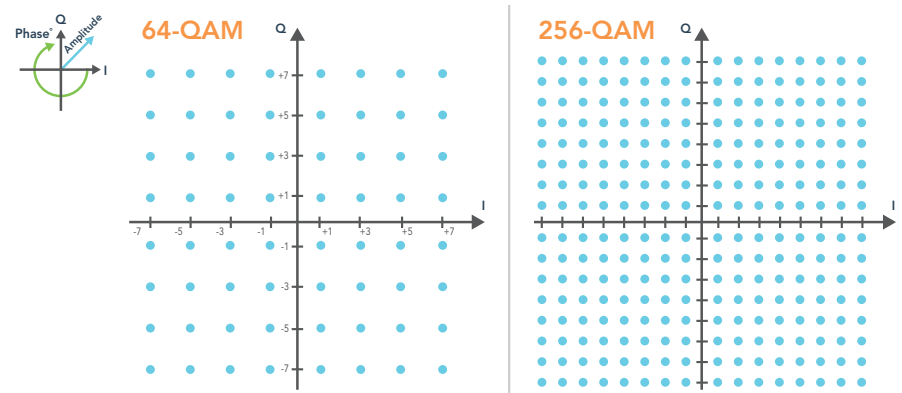

Figure 20. Physical Layer Data Encoding

802.11n uses 16 Quadrature Amplitude Modulation (QAM), which conveys  $\log_2(16) = 4$  bits per symbol and 64 QAM, which conveys 6 bits per symbol. 802.11ac adds 256 QAM which conveys 8 bits per symbol for a 33% increase in throughput vs. the highest 802.11n data rate.

You may select the highest Modulation and Coding Scheme (MCS) level allowed with **1, 2, or 3 Spatial Streams** (see the **Max MCS** setting in [“Procedure for Configuring Global 802.11ac IAP Settings”](#) on page 357). You may limit the highest level of modulation to 64-QAM, or allow 256-QAM. It also determines the coding scheme used for error correction. Higher MCS levels allocate fewer bits to error correction, and thus more bits are used for data. The default value is **MCS9**, the highest level.

The higher the MCS value, the higher the data rate, as shown in the table below. Riverbed APs support MCS7 -MCS9. Higher MCS levels require higher signal-to-noise ratios (i.e., a less noisy environment) and shorter transmission distances.

MCS index value	Modulation	Code rate (R)
0	BPSK	1/2
1	QPSK	1/2
2	QPSK	3/4
3	16-QAM	1/2
4	16-QAM	3/4
5	64-QAM	2/3
6	64-QAM	3/4
7	64-QAM	5/6
8	256-QAM	3/4
9	256-QAM	5/6

### Higher Channel Widths (Bonding)

Channel bonding increases data rates by combining two, four, or eight adjacent 20MHz channels into one channel. This increases the data rate proportional to the width of the bond.

Bonding is specified on the [IAP Settings](#) page for each IAP in terms of the primary channel and the width of the bond. Be aware that Channel Bonding impacts channel planning, since you are using multiple channels per IAP.

802.11ac allows creation of 20, 40, 80, or (in Wave 2 APs) 160MHz wide channels. (Riverbed currently supports channels up to 80MHz wide.) The 160MHz channel can also be a combination of two non-contiguous 80MHz channels (80+80). Although channel bonding increases bandwidth, wider channels are more susceptible to signal interference which may lead to reduced range and poorer signal quality. [Figure 21](#) is an example showing how Channels 36-64 may be used:



as eight 20MHz channels; four 40MHz channels; two 80MHz channels; or one 160MHz channel.

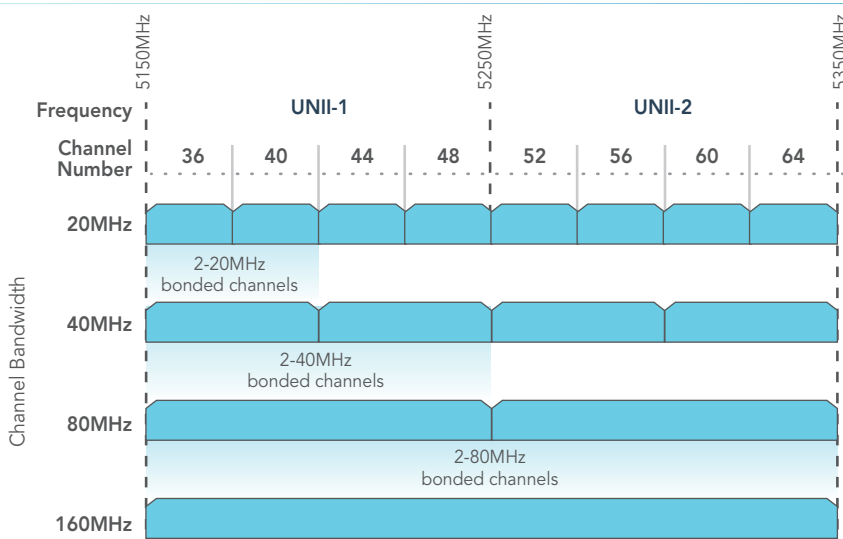

Figure 21. Channel Bonding (Channels 36-64 shown)

### 802.11ac Data Rates

Maximum Data Rate	# Transmit Antennas	Bandwidth (MHz)	# Streams	Modulation	
293Mbps	1	40	1	64QAM	Phase 1
433Mbps	1	80	1	256QAM	
867Mbps	2	80	2	256QAM	
1.299Gbps	3	80	3	256QAM	
1.730Gbps	4	80	4	256QAM	
3.470Gbps	8	80	8	256QAM	Phase 2+
867Mbps	1	160	1	256QAM	
1.730Gbps	2	160	2	256QAM	
3.470Gbps	8	160	4	256QAM	
6.930Gbps	8	160	8	256QAM	

Figure 22. Maximum 802.11ac Data Rates

IEEE 802.11ac data rates are dependent on the number of spatial streams obtained through the use of MU-MIMO, 80 vs. 160MHz channel widths, the number of transmit antennas, and the type of modulation. [Figure 22](#) shows the maximum data rate achievable at each level, with many additional lower rates occurring at each level dependent on signal level, signal to noise ratio in the environment, etc.

Phase 1 802.11ac, first available in consumer products in 2012 and enterprise products in 2013, supports up to 80MHz channels and up to 3 spatial streams for a maximum data rate of 1.3Gbps.

Phase 2 and beyond products, expected starting in 2014, will add 160MHz channels and up to 8 spatial streams for a maximum data rate of 6.9Gbps.

### ACExpress™

Riverbed 802.11ac IAPs use ACExpress™ to optimize wireless performance by automatically separating faster 802.11ac clients from slower Wi-Fi clients. Since Wi-Fi is a shared medium, this separation ensures that slower 802.11a/b/g/n clients do not starve the performance of 802.11ac clients. For example, the data rate of an 802.11n client is less than 25% of the rate of an 802.11ac client, and thus will take four times as much air time for a given amount of data. This takes available bandwidth away from faster clients, reducing their performance significantly. ACExpress intelligently separates clients by type onto different radios, grouping fast clients separately from slow clients, thereby maximizing performance for all. ACExpress is supported on all Riverbed 802.11ac products, and may be enabled or disabled as part of the Load Balancing feature. See [Step 28 on page 337](#).

### 802.11ac Deployment Considerations

The theoretical data rates shown are just that, theoretical. For 802.11ac deployments, numerous factors affect real-world performance. These are some important considerations in the deployment of networks that include 802.11ac:

- **Wireless networks are not wired networks.** Wired network users who share a Gigabit network can expect to see bursts of up to 900Mbps, depending on their hardware. Maximum Wi-Fi data rates are reduced by signaling overhead and media contention. Most 802.11ac users will see

data rates less than 100Mbps as the effective bandwidth is shared among all devices connecting to a given radio.

- **Migration to 802.11ac will take time.** Older Wi-Fi technologies will continue to be with us for years. In order for 802.11ac to provide maximum data rates, it is important to keep interference from earlier Wi-Fi standards at a minimum. For example, 802.11n devices operating in the 5GHz band can slow down 802.11ac devices to 300Mbps or 450Mbps depending on the 2x2 or 3x3 MIMO technology used.
- **Infrastructures must be upgraded as well.** The bandwidth required out of 802.11ac APs will certainly exceed 1Gbps and may reach 10Gbps. The links from the APs to the core network must keep pace with this need. Centralized firewalls, LAN controllers, and authentication servers may also reach their limits. Migration to a decentralized architecture, with intelligence at the edge of the network may be a more scalable solution, avoiding single points of failure.
- **More power.** Multi-antenna APs handling 802.11ac speeds will likely require more power. Power planning for your access switches should be carefully considered.
- **A new site survey may be needed.** Wireless networks established as recently as a few years ago were probably designed for coverage and not capacity. APs were placed so that there were no dead zones, without considering future capacity needs. With the increasing use of mobile devices, new site surveys that ensure enough bandwidth for anticipated usage should precede deployment of 802.11ac APs.
- **Manage application usage.** With 802.11ac, a range of applications are now practical on mobile devices that were previously only used over wired networks or on laptops. Uncontrolled use of Wi-Fi bandwidth can cause wireless networks to quickly degrade. Network control elements must control use of applications and prioritize critical applications.
- **Upgrading with 802.11ac radio modules.** Riverbed offers modular APs that enable you to evolve the capacity of your APs as your needs grow.

XI Series 802.11ac Wireless Access Points (APs) are offered in three models: 867 Mbps (2X2 MIMO), 1300 Mbps (3X3 MIMO), or 3470 Mbps (4x4 MU-MIMO).

When you add IAPs to an AP or replace 802.11n IAPs with 802.11ac modules, the Access Point determines its model number based on the count and types of radios. For example, if you add four 1300 Mbps (3X3 MIMO) IAPs to an XR-4420, the AP will display its model number as XR-4836 because it now has eight 3x3 IAPs including 802.11ac radios.



*Riverbed highly recommends that the upgraded AP have a radio count that matches one of our standard APs (e.g., XR-4000 with 4 or 8 radios, XR-2000 with 2 or 4). The AP may have more of one type of radio than another. For example, an upgraded XR-4830 may have six 802.11n radios and two 802.11ac radios, or vice versa.*

## Failover Planning

This section discusses failover protection at the unit and port levels. To ensure that service is continued in the event of a port failure, you can utilize two Gigabit Ethernet ports simultaneously as a bonded pair (on APs with two or more Gigabit ports).

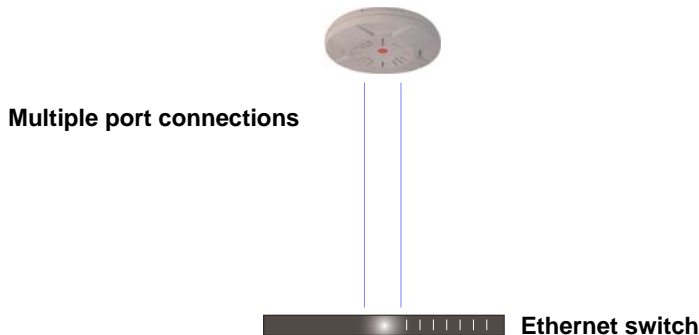

Figure 23. Port Failover Protection

## Wireless Access Point

---

In addition, the AP has full failover protection between the bonded-pair Gigabit ports (see following table).

Interface	Bridges Data?	Bridges Management Traffic?	Fails Over To:	IP address
Gigabit port	Yes	Yes	Bonded port	DHCP or static
Bonded Gigabit port	Yes	Yes	Bonded port	Same

The Wireless AP Gigabit Ethernet ports actually support a number of modes:

- 802.3ad Link Aggregation
- Load Balancing
- Broadcast
- Link Backup
- Mirrored

For more details on Gigabit port modes and their configuration, please see [“Bonds and Bridging” on page 177](#).

### Switch Failover Protection

To ensure that service is continued in the event of a switch failure, you can connect APs having multiple Gigabit ports to more than one Ethernet switch (not a hub).



Figure 24. Switch Failover Protection



*Gigabit Ethernet connections must be on the same subnet.*

#### *See Also*

- Coverage and Capacity Planning
- Installation Prerequisites
- Network Management Planning
- Planning Your Installation
- Power Planning
- Security Planning

### Power Planning

All AP models support Power over Ethernet (PoE) with an integrated splitter.

#### Power over Ethernet

To deliver power to the AP, you must use Riverbed-supplied Power over Ethernet (PoE) modules or powered switches that are compatible with your AP. They provide power over Cat 5e or Cat 6 cables to the AP without running power cables—see [Figure 4 on page 20](#).

Specific models of the AP are compatible with specific PoGE modules. For details, please see the *Power over Gigabit Ethernet Installation and User Guide*.



*When using Cat 5e or Cat 6 cable, power can be provided up to a distance of 100m.*

*Certain models (XR-500/600 Series and some XR-2000 models) also accept IEEE802.3af and/or IEEE802.3at powered switch ports.*

#### *See Also*

[Coverage and Capacity Planning](#)

[Failover Planning](#)

[Network Management Planning](#)

[Security Planning](#)

## Security Planning

This section offers some useful guidelines for defining your preferred encryption and authentication method. For additional information, see [“Understanding Security” on page 231](#) and the [Security](#) section of [“Frequently Asked Questions” on page 532](#).

## Wireless Encryption

Encryption ensures that no user can decipher another user’s data transmitted over the airwaves. There are three encryption options available to you, including:

- **WEP-40bit or WEP-128bit**  
Because WEP is vulnerable to cracks, we recommend that you only use this for legacy devices that cannot support a stronger encryption type.
- **Wi-Fi Protected Access (WPA)**  
This is much more secure than WEP and uses TKIP for encryption.
- **Wi-Fi Protected Access (WPA2) with AES**  
This is government-grade encryption—available on most new client adapters—and uses the AES-CCM encryption mode (Advanced Encryption Standard-Counter Mode).

## Authentication

Authentication ensures users are who they say they are. Users are authenticated when they attempt to connect to the wireless network and periodically thereafter. The following authentication methods are available with the Wireless AP:

- **RADIUS 802.1x**  
802.1x uses a remote RADIUS server to authenticate large numbers of clients, and can handle different authentication methods (EAP-TLS, EAP-TTLS, EAP-PEAP, and EAP-LEAP Passthrough). Administrators may also be authenticated via RADIUS when preferred, or to meet particular security standards.
- **Riverbed Internal RADIUS server**  
Recommended for smaller numbers of users (about 100 or less). Supports EAP-PEAP only



- **Pre-Shared Key**  
Uses a pass-phrase or key that is manually distributed to all authorized users. The same passphrase is given to client devices and entered into each AP.
- **MAC Access Control Lists (ACLs)**  
MAC access control lists provide a list of client adapter MAC addresses that are allowed or denied access to the wireless network, and can be used in addition to any of the above authentication methods. ACLs are good for embedded devices, like printers and bar-code scanners (though MAC addresses can be spoofed). The AP supports 1,000 global ACL entries. You may also define per-SSID access control lists, with up to 1000 entries each.

### Meeting PCI DSS Standards

The Payment Card Industry (PCI) Data Security Standard (DSS) was developed by major credit card companies. It lays out a set of requirements that must be met in order to provide adequate security for sensitive data. The AP may be configured to assist in satisfying PCI DSS standards. For details, please see [“Auditing PCI DSS” on page 603](#). Note that the license installed on the AP must include the Advanced RF Security Manager (RSM) to support the PCI audit command.

### Meeting FIPS Standards

The Federal Information Processing Standard (FIPS) Publication 140-2 establishes a computer security standard used to accredit cryptographic modules. The standard is a joint effort by the U.S. and Canadian governments. To implement Level 2 security requirements of FIPS Level 2 on the Wi-Fi AP, see [“Implementing FIPS Security” on page 609](#).

### *See Also*

[Failover Planning](#)

[Network Management Planning](#)

[Power Planning](#)

## Port Requirements

A number of ports are used by various AP features and by the Xirrus Management System (XMS). The [Port Requirements table on page 63](#) lists ports and the features that require them (XMS port requirements are included in the table for your convenience). If you are using a feature, please make sure that the ports that it requires are not blocked by firewalls or other policies, and that they do not conflict with any other port assignments.

As an example, XMS-Enterprise port requirements are illustrated in [Figure 25](#). Ports 161, 162, and 443 must be passed between APs and the XMS server. Similarly, port 9443 is required for communication between the XMS server and XMS clients, and port 25 is typically used by the XMS server to access an SMTP server to send email notifications.

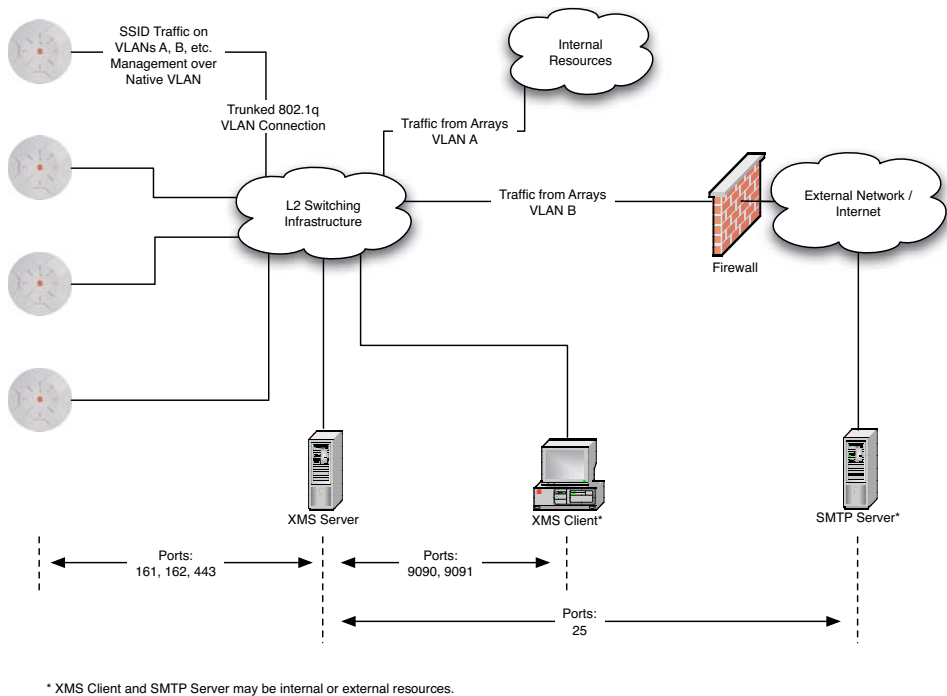

Figure 25. Port Requirements for XMS-Enterprise

## Wireless Access Point

The following table lists port requirements for the AP and for XMS, how the ports are used, and whether they may be changed.

Port	Application	Peer	Configurable
<b>AP</b>			
icmp	Ping	XMS Server	No
20 tcp 21 tcp	FTP	Client	Yes
22 tcp	SSH	Client	Yes
23 tcp	Telnet	Client	Yes
25 tcp	SMTP	Mail Server	No
69 udp	TFTP	TFTP Server	No
123 udp	NTP	NTP Server	No
161 udp	SNMP	XMS Server	No
162 udp	SNMP Traphost Note - Up to four Traphosts may be configured.	XMS Server	Yes - but required by XMS
443 tcp	HTTPS (WMI,WPR)	Client	Yes
514 udp	Syslog	Syslog Server	No
1812, 1645 udp	RADIUS (some servers use 1645)	RADIUS Server	Yes
1813, 1646 udp	RADIUS Accounting (some servers still use 1646)	RADIUS Accounting Server	Yes
2055 udp	Netflow	Client	Yes
5000 tcp	Virtual Tunnel	VTUN Server	Yes
22610 udp	Riverbed Roaming	APs	Yes
22612 udp	Xircon (Console Utility)	Admin Workstation	Yes

Port	Application	Peer	Configurable
<b>XMS-Cloud</b>			
443 tcp	HTTPS	APs	No
<b>XMS-Enterprise</b>			
icmp	Ping	APs	No
22 tcp	SSH	APs	Yes
25 tcp	SMTP	Mail Server	Yes
123 udp	NTP	NTP Server	No
161 udp	SNMP	APs	No
162 udp	SNMP Traphost 1	APs	Via XMS config file
443 tcp	HTTPS	APs	No
514 udp	Resident Syslog server	Internal*	Via XMS config file
1099 tcp	RMI Registry	Internal*	No
2000 tcp	XMS Back-end Server	Internal*	No
2022 tcp	SSH	AP	Yes
3306 tcp	MySQL Database	Internal*	No
8001 tcp	Status Viewer	Internal*	No
8007 tcp	Tomcat Shutdown	Internal*	During installation
8009 tcp	Web Container	Internal*	During installation
8085 tcp	Web Socket Communications	Access Points	No
9090 tcp	XMS Webserver	XMS client	During installation

## Wireless Access Point

---

Port	Application	Peer	Configurable
9091 tcp	XMS Client Server	XMS client	Via XMS config file
9092 tcp	XMS Client Server	XMS client	Via XMS config file
9443 tcp	XMS WMI SSL	XMS web client	Yes
9444 tcp	Secure Web Socket	Access Points	No
* Internal to XMS Server, no ports need to be unblocked on other network devices			

### *See Also*

[Management Control](#)

[External Radius](#)

[Services](#)

[VLAN Management](#)

## Network Management Planning

Network management can be performed using any of the following methods:

- Centralized Web-based management, using the optional Xirrus Management System (XMS). XMS-Cloud provides zero-touch provisioning and ongoing management. XMS is hosted on a dedicated Riverbed appliance or your own server. XMS manages large Wireless AP deployments from a centralized Web-based interface and offers the following features:
  - ◆ Globally manage large numbers of APs
  - ◆ Seamless view of the entire wireless network
  - ◆ Easily configure large numbers of APs
  - ◆ Rogue AP monitoring
  - ◆ Easily manage system-wide firmware updates
  - ◆ Monitor performance and trends
  - ◆ Aggregation of alerts and alarms
- The AP's Command Line Interface, using an SSH (Secure Shell) utility, like PuTTY. The utility **must** be set up to use SSH-2, since the AP will only allow SSH-2 connections.
- Web-based management, using the AP's embedded Windows Management Interface (WMI). This method provides configuration and basic monitoring tools, and is good for small deployments (one or two units).

### *See Also*

[Failover Planning](#)

[Power Planning](#)

[Security Planning](#)

## WDS Planning

WDS (Wireless Distribution System) creates wireless backhaul connections between APs, allowing your wireless network to be expanded using multiple APs without the need for a wired backbone to link them (see [Figure 26](#)). WDS features include:

- One to three IAPs may be used to form a single WDS link, yielding up to 1350 Mbps bandwidth per link. Up to three different WDS links may be created on a single AP.
- Automatic IAP load balancing
- If desired, you may allow clients to associate to a BSS on the same radio interface used for a WDS Host Link. This will take bandwidth from the WDS link.



Figure 26. WDS Link

- Multiple links per AP allow you to configure multi-hop connections.

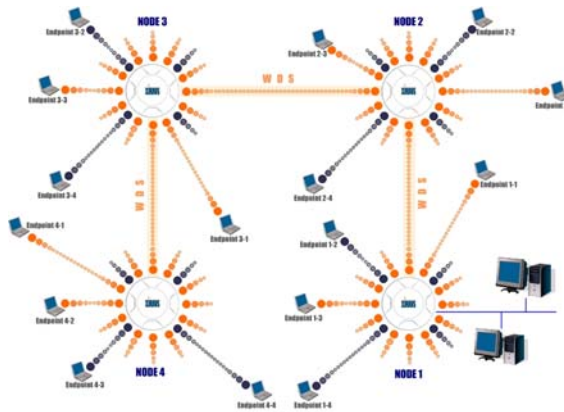

Figure 27. A Multiple Hop WDS Connection

- Multiple WDS links can provide link redundancy (failover capability - see [Figure 28](#)). A network protocol (Spanning Tree Protocol—STP) prevents APs from forming network loops.

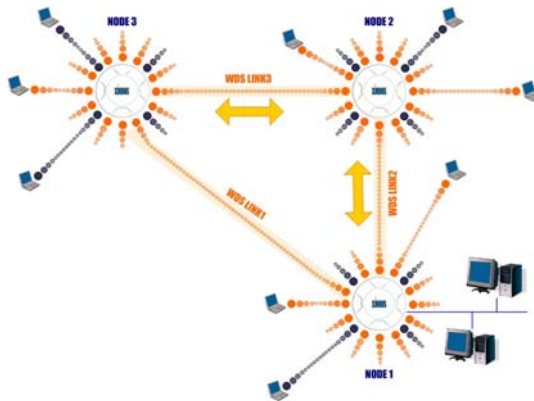

Figure 28. WDS Failover Protection



WDS links have a Host/Client relationship similar to the usual IAP/station pattern for APs:

- A *WDS Client Link* associates/authenticates to a host (target) AP in the same way that stations associate to IAPs. The client side of the link must be configured with the root MAC address of the target (host) AP.
- A *WDS Host Link* acts like an IAP by allowing one WDS Client Link to associate to it. An AP may have both client and host links.

WDS configuration is performed only on the client-side AP. See “WDS” on [page 391](#). Note that both APs must be configured with the same SSID name.

### Common Deployment Options

The following table lists some typical and recommended deployment options for a number of the features that have been discussed in this chapter.

Function	Number of Wireless APs	
	One or Two	Three or More
Power	Power over Ethernet	Power over Ethernet UPS backup (recommended)
Failover	Recommended	Highly recommended
VLANs	Optional	Optional use, Can be used to put all APs on one VLAN or map to existing VLAN scheme
Encryption	WPA2 with AES (recommended)  PSK or 802.1x	WPA2 with AES (recommended)  802.1x keying
Authentication	Internal RADIUS server EAP-PEAP  Pre-Shared Key	External RADIUS server
Management	Cloud XMS or Internal WMI  Internal CLI (via SSHv2)	Cloud XMS or XMS (Enterprise-hosted)

#### *See Also*

[Coverage and Capacity Planning](#)

[Network Management Planning](#)

[Planning Your Installation](#)

[Power Planning](#)

[Security Planning](#)

## Installation Workflow

This workflow illustrates the steps that are required to install and configure the AP successfully. Review this flowchart before attempting to install the unit on a customer's network. Cloud XMS customers will skip the last two steps.

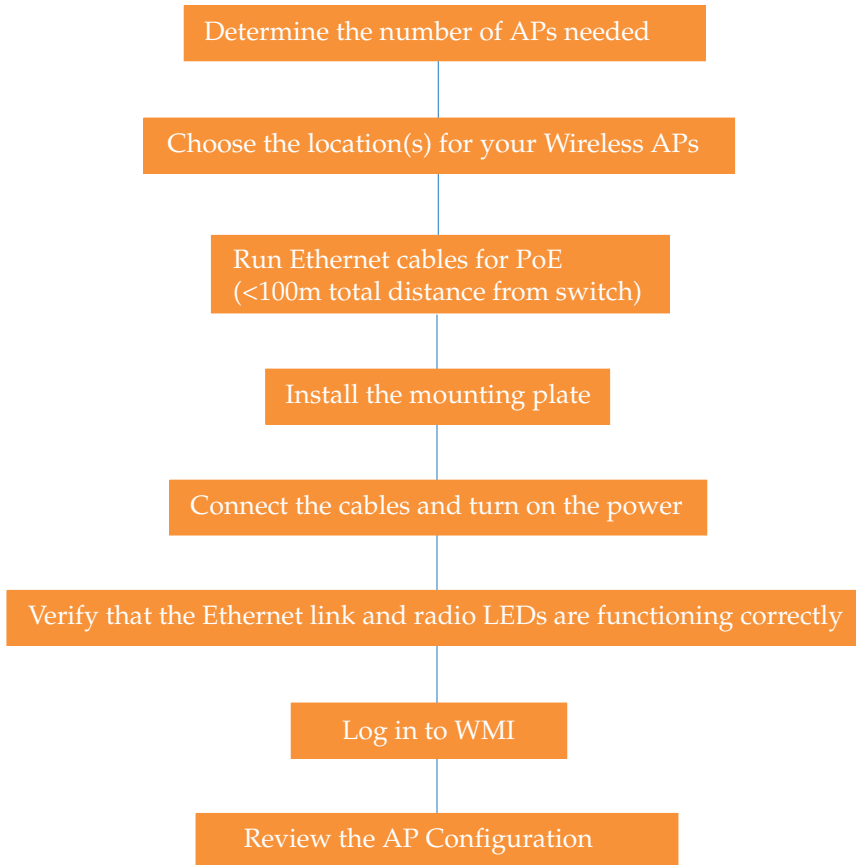

Figure 29. Installation Workflow

*See Also*

Coverage and Capacity Planning  
Common Deployment Options

Failover Planning  
Installation Prerequisites  
Planning Your Installation  
Power Planning  
Wireless Access Point Product Overview  
Security Planning

## Installing Your Wireless AP

This section provides information about the physical installation of your Riverbed Wireless AP. For complete instructions, please see the Installation Guide for your model of AP or Access Point.

### Choosing a Location

Based on coverage, capacity and deployment examples previously discussed, choose a location for the AP that will provide the best results for your needs. The Wireless AP was designed to be mounted on a ceiling where the unit is unobtrusive and wireless transmissions can travel unimpeded throughout open plan areas.

Choose a location that is central to your users (see the following diagram for correct placement).

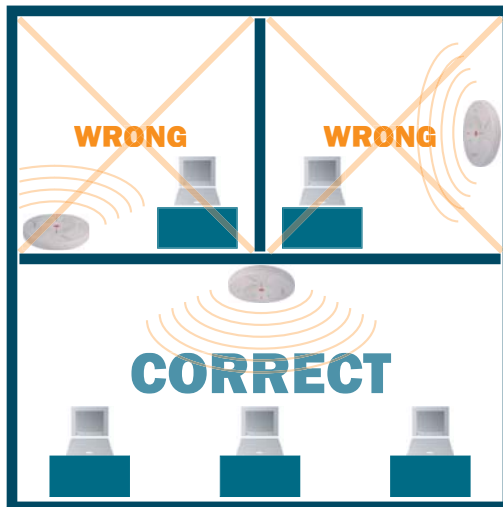

Figure 30. AP Placement

### Wiring Considerations

Before using the Riverbed-supplied PoE to distribute power, see [“Power over Ethernet \(PoE\)”](#) on page 20.

Once you have determined the best location for your Wireless AP, you must run cables to the location for the following services:

### **Power**

No separate power cable is required to the AP—Riverbed wireless APs use PoE (Power over Ethernet). See the Installation Guide for your AP model for compatible power injectors or switches.

The total of all Cat 5e or Cat 6 cable segments from the Gigabit Ethernet switch to the power injector and then to an AP PoE port must be less than 100m long. The AP must be connected to PoE networks without routing cabling to the outside plant, to ensure that cabling is not exposed to lightning strikes or possible high voltage crossover.

### **Network**

APs have at least one PoE port to supply power and data over the same cable. Many models have additional Gigabit ports, or even additional PoE ports. Please see the Installation Guide for your AP model for detailed information about running cables to the AP and connecting it.

Some models also have a serial (console) port. The Serial cable may be up to 25 feet long per the RS-232 specification.



*When the unit's IP address is unknown or a network connection has not been established, the serial cable is used for connecting directly with the Command Line Interface (CLI) via HyperTerminal. When a network connection is established, the AP can be managed from any of the available network connections, either Gigabit 1 or Gigabit 2.*

*For models with no console port, such as the XR-500, XR-1000, and some XR-2000 models, the Xircon utility may be used locally to set up an IP address if necessary.*

### ***Important Note About Network Connections***

**!** *The AP's Ethernet ports should be plugged into an Ethernet switch, not an Ethernet hub—if a hub is used, we recommend that you connect only one Ethernet port.*

### ***See Also***

Failover Planning

Installation Prerequisites

Installation Workflow

Mounting and Connecting the AP

Power over Ethernet (PoE)

### Mounting and Connecting the AP

A detailed Installation Guide is available at [support.xirrus.com](http://support.xirrus.com) that describes mounting your AP. Please follow the provided instructions carefully. Data and power connections to the AP are also detailed in the Installation Guide. Please follow the cabling and connection instructions carefully.

### Dismounting the AP

For all AP models, push up on the AP (i.e., push it against the mounting plate). Then turn the AP to the left to remove it. This is similar to dismounting a smoke detector.

### Powering Up the Wireless AP

When powering up, the AP follows a specific sequence of LED patterns showing the boot progress, and following a successful boot will provide extensive status information.

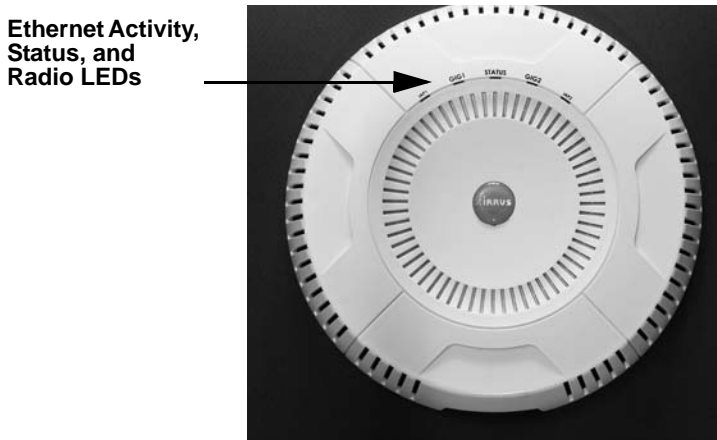

Figure 31. LED Locations

AP LED settings may be altered or disabled entirely for diagnostic purposes or for personal preference. Changes are made via the AP’s Command Line Interface or the Windows Management Interface—refer to “LED Settings” on page 385.



## AP LED Operating Sequences

Use the following tables to review the operating sequences of the AP’s LEDs.

- [“LED Boot Sequence” on page 77](#)
- [“LED Operation when AP is Running” on page 78](#)

### LED Boot Sequence

The normal boot LED sequence is as follows:

AP Activity	Status LED	IAP LEDs
<b>Power ON</b>	Blinking GREEN	All OFF
<b>Boot loader power ON self-test</b>	Blinking GREEN	All ON
<b>Image load from compact FLASH</b>	Blinking GREEN	Spinning pattern (rotate all to ON, then all to OFF)
<b>Image load failure</b>	Blinking ORANGE	All OFF
<b>Hand off to ArrayOS</b>	Solid GREEN	All OFF
<b>System software initialization</b>	Solid GREEN	Walking pattern—(LED rotating one position per second)
<b>Up and running</b>	Solid GREEN	ON for IAPs that are up: OFF for IAPs that are down. Green or orange per table on the next page. Behavior may be changed using <a href="#">“LED Settings” on page 385</a> .

### LED Operation when AP is Running

The normal LED operation when the AP is running is shown in the table below. Note that behavior may be modified using “LED Settings” on page 385 or via the CLI.

LED Status	Reason
<b>IAP LED is OFF</b>	IAP is down
<b>IAP LED is solid ON</b>	IAP is up, but no associations and no traffic
<b>IAP LED heartbeat</b>	IAP is up, with stations associated but no traffic
<b>IAP LED flashing</b> Flashing at 10 Hz Flashing at 5 Hz Flashing at 2.5 Hz	IAP is up, passing traffic Traffic > 1500 packets/sec Traffic > 150 packets/sec Traffic > 1 packet/sec
<b>IAP LED is GREEN</b>	IAP is operating in the 2.4 GHz band
<b>IAP LED is ORANGE</b>	IAP is operating in the 5 GHz band
<b>IAP LED flashing ORANGE to GREEN at 1 Hz</b>	The radio is in monitor mode (standard intrude detect)
<b>STATUS LED is GREEN ***</b>	AP is operational
<b>GIG (Ethernet) LEDs are dual color</b> <b>Ethernet LED is ORANGE</b> <b>Ethernet LED is GREEN</b>	Transferring data at 1 Gbps Transferring data at 10/100 Mbps
<p><i>*** NOTE: On an XR-2000 Series AP model ending in 5 or 6, there is a combined GIG2/STS LED. If the GIG2 port is not connected, the LED behaves as a Status LED. If the GIG2 port is connected, the LED behaves as a GIG2 LED.</i></p>	

### *See Also*

[Installation Prerequisites](#)

[Installation Workflow](#)

[Installing Your Wireless AP](#)

[LED Settings](#)

## Zero-Touch Provisioning and Ongoing Management

Most customers employ the Xirrus Management System (XMS) for the initial setup and continuing management of Riverbed devices. XMS users can readily set up their new devices for zero touch provisioning and ongoing maintenance via the following platforms.

### **XMS-Cloud Next Generation (XMS-9500-CL-x)**

XMS in the cloud performs zero touch provisioning. New APs appear in XMS even before you receive your equipment. When the email arrives with your login information, use XMS Cloud to specify the initial settings for your APs. A Guided Tour will walk you through the basic steps of creating a profile containing configuration settings, including creating SSIDs and firewall/application control rules. Once a new, unlicensed AP is connected to a network with DHCP and Internet connectivity, it will automatically contact Riverbed for cloud-based zero touch provisioning per your settings. It will first install the latest applicable license, and upgrade the AP to the latest software version as appropriate.

### **XMS-Enterprise**

This enterprise-hosted platform automatically detects and provisions new Riverbed devices deployed in your network via a zero touch provisioning approach similar to that described above. Create and configure a default profile for newly added APs—these new devices will automatically receive the configuration defined in your default profile.



*If you are an XMS customer, we recommend that you manage your APs completely by XMS. Wait five minutes after powering up the AP or Access Point, then use XMS to view/manage this unit. If you change settings directly on the AP, XMS may not sync up with these changes for up to 24 hours.*



*Note that the AP must already be running ArrayOS release 6.5 or above to support zero-touch provisioning.*

### If you are not using XMS

If you are not using XMS, please proceed to the rest of this chapter to configure your AP manually via the Express Setup menu option.

## AP Management Interfaces

### User Interfaces

With zero-touch setup provided by XMS, your Riverbed network is ready for use a few minutes after deployment. We recommend that you use the XMS for ongoing monitoring and fine-tuning of the network. (For XMS-E, you must set up a default profile and discovery first, to find new APs).

To check the configuration of individual APs locally, AP settings may be viewed or configured through the Command Line Interface (CLI) using SSH, or on a browser with the Windows Management Interface (WMI). You may use the CLI via the serial management port (console—on all APs except the XR-500/600/1000 Series and some XR-2000 models) or any of the Gigabit Ethernet ports. You can use the WMI via any of the AP's Ethernet ports.

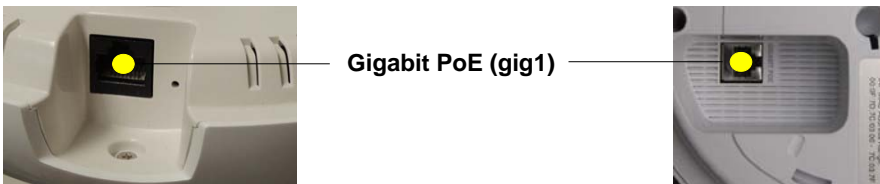

Figure 32. Network Interface Ports—XR-520 (left); XR-1000 Series (right)

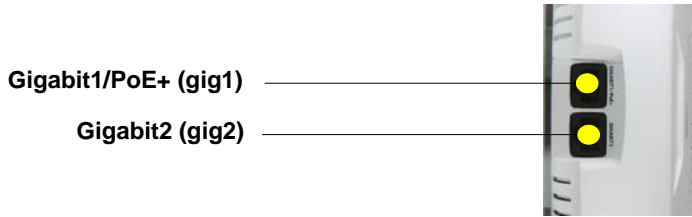

Figure 33. Network Interface Ports—XR-600 Series

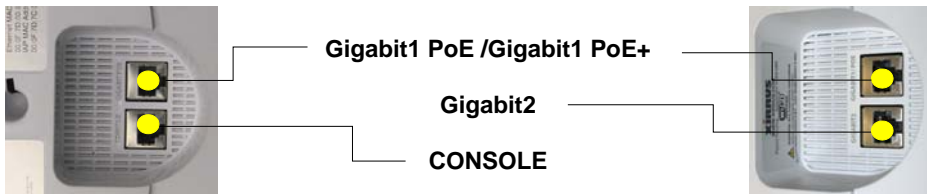

Figure 34. Network Interfaces—XR-2000 Series (left); XR-2005/2006 (right)

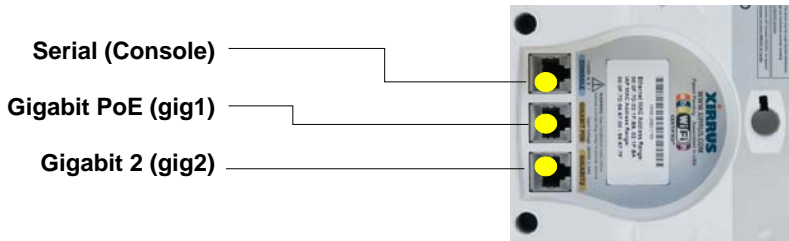

Figure 35. Network Interface Ports—XR-4000 Series

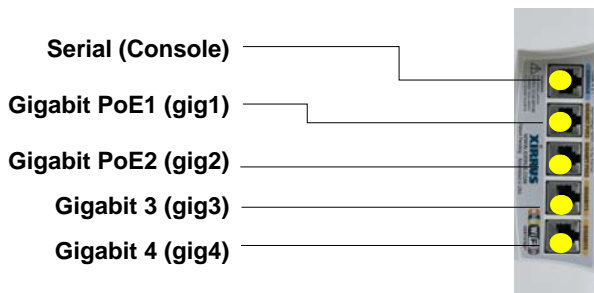

Figure 36. Network Interface Ports—XR-6000 Series



*The Xircon utility may also be used to communicate with APs locally as an alternative to using a serial connection to the console. This is especially useful for the XR-500/600/1000 Series and some XR-2000 models, which do not have a console port. See “Securing Low Level Access to the AP” on page 85.*

### Using the Serial Port

If using the serial port to make your connection, use serial settings of 8 bits, no parity, no flow control, 1 stop bit (8N1) and a speed setting of 115200 baud. Use the communication package of your choice. You may use the serial port to change settings on the AP, even if the AP’s Gigabit interfaces are in XMS managed mode (i.e., read-only mode, see “Managing APs Locally or Using XMS” on page 89).

### Using the Ethernet Ports to Access the AP

By default, the AP’s Ethernet interfaces use DHCP to obtain an IP address. If the AP is booted and does not receive DHCP addresses on Gigabit Ethernet ports, then both Gigabit1 and its bonded pair port (if any) will default to 10.0.2.1 with a mask of 255.255.255.0.

If the AP is connected to a network that provides DHCP addresses, the IP address can be determined by the following methods:

1. The simplest way to address the AP is using its default hostname which is the AP’s serial number, found on the AP label and shipping container (for example, XR40123091CACD). If your network provides DHCP and DNS, then you can use this hostname.
2. Otherwise, examine the DHCP tables on the server and find the addresses assigned to the AP (Riverbed MAC addresses begin with 00:0F:7D or 50:60:28 and are found on the AP label and shipping container).
3. Alternatively, you may query the AP using the CLI via the console port (on all models except the XR-500/600/1000, and some XR-2000 models). Log in using the default user name **admin** and password **admin**. Use the **show ethernet** command to view the IP addresses assigned to each port.

4. If the AP cannot obtain an IP address via DHCP, the factory default uses a static IP address of 10.0.2.1 with a mask of 255.255.255.0 on its Gigabit POE port.



*Take care to ensure that your network is not using the 10.0.2.1 IP address prior to connecting the AP to the network.*

To connect to the AP, you must set your laptop to be in the same subnet as the AP: set your laptop's IP address to be in the 10.0.2.xx subnet, and set its subnet mask to 255.255.255.0. If this subnet is already in use on your network, you may connect your laptop directly to the AP by connecting the laptop to the power injector's IN port temporarily (this port may be called the SWITCH port or the DATA port on your injector).

### Starting the WMI

Use this procedure to log in to the WMI on a Web browser.

1. Establish a network connection and open your Web browser.
2. Connect to the Wireless AP using its host name or IP address as described in the previous section.

*http://<hostname or IPaddress>*

### Logging In

Enter the default user name and password—the default user name is **admin**, and the default password is **admin**.

#### *See Also*

[Installation Workflow](#)

[Performing the Express Setup Procedure](#)

[Powering Up the Wireless AP](#)

## Licensing

When a newly deployed AP boots up, it automatically contacts Riverbed with its serial number and MAC address and obtains its license key, software image, and initial configuration from XMS. Any unlicensed AP running ArrayOS release 6.5 or above will update in this way after it boots up, if it has Internet connectivity and if you are running XMS (you must have a default profile set up in XMS).

The AP's license determines some of the features that are available on the AP. For example, the Application Control feature on APs requires a license. When a new AP first boots, it self-generates a license for its current software version. No upgrades or licensed features will operate until the AP receives a license obtained from Riverbed. The AP's license is not installed at the factory.

If you need to enter the license manually, use the following procedure. It describes entering the license key using the WMI. If you are using the XMS, you may use it to manage and upgrade large numbers of licenses for the wireless network.

1. This procedure assumes that you have pointed a browser to the AP to start WMI, and that you have logged in with the default username and password above.
2. In the left hand frame, in the **Configuration** section, click **Express Setup**.
3. **License Key:** Enter the key License Activation Code (LAC) that was provided for the AP. The key was provided to you in an email as an attachment in the form of an Excel file (.xls). Enter the key exactly as it appears in the file. Click the **Apply** button to apply the key.
4. Now you may verify the features provided by the key. In the **Status** section of the left hand frame, click AP and then click **Information**. Check the items listed in the **License Features** row.

## Performing the Express Setup Procedure

The Express Setup procedure establishes global configuration settings that enable basic AP functionality. Changes made in this window will affect all radios. If you are not using XMS to perform your initial configuration, please see [“Express](#)



Setup” on page 167. Also see “Zero-Touch Provisioning and Ongoing Management” on page 79.

### *See Also*

[Zero-Touch Provisioning and Ongoing Management](#)

[Installation Prerequisites](#)

[Installation Workflow](#)

[Logging In](#)

[Multiple SSIDs](#)

[Security](#)

### **Securing Low Level Access to the AP**

Most local management of the Riverbed AP is done via the WMI or CLI—see “[The Command Line Interface](#)” on page 437. The AP also has a lower level interface: XBL(Riverbed Boot Loader), which allows access to more primitive commands. You won’t normally use XBL unless instructed to do so by Riverbed Customer Support. For proper security, you should replace the default XBL login username and password with your own, as instructed below. XBL has its own username and password, separate from the ArrayOS Admin User and Password (used for logging in to the WMI and CLI) that you may change on the [Express Setup](#) page (see [Step 5 on page 171](#)).

Riverbed also provides the Xircon utility for connecting to Riverbed APs that are not reachable via the normal access methods such as Secure Shell (SSH) or WMI and that do not have a physical console port, or whose console port is not accessible. Xircon discovers APs on your network subnet by sending IP/UDP broadcast packets. Once an AP is discovered, Xircon can establish an encrypted console session to the AP via the network even if the AP IP configuration is incorrect. Xircon allows you to manage the AP using CLI, just as you would if connected to the console port. Xircon also has an option for easily accessing XBL.

In normal circumstances Riverbed APs should be configured and managed through SSH or via the WMI. A connection is established using either the AP hostname or DHCP-assigned IP address, or via the other options described in “[Using the Ethernet Ports to Access the AP](#)” on page 82. Xircon may be needed in special circumstances as directed by Riverbed Customer Support for

troubleshooting AP problems or IP connectivity. (In this case, see the *Xircon User Guide* for detailed information.)

Xircon access to the AP:

- You may enable or disable all Xircon access to the AP as instructed in the procedure below. There are also options to allow access only to CLI (i.e., ArrayOS access) or only to XBL.
- Since some models do not have a console port, these models have Xircon access to both XBL and CLI enabled by default. For APs that do not have a console port, to avoid potentially being locked out of the AP, Xircon should always be enabled at the XBL level at least.

! *If you disable Xircon access to both XBL and CLI on models with no console port, you must ensure that you do not lose track of the username and password to log in to CLI/WMI! In this situation, there is no way to recover from a lost password, other than returning the AP to Riverbed. If you have Xircon access to XBL enabled, you can reset the password, but this recovery will require setting the unit to factory defaults with loss of all configuration data.*

- On all other AP models (those with a console port), Xircon access to both XBL and CLI is disabled by default. If Xircon is not going to be used to access an AP, we recommend leaving Xircon access disabled.

### *Procedure for Securing Low Level AP Access*

Use the following steps to replace the default XBL username and password, and optionally to change the type of Xircon management access that is allowed. These steps use CLI commands.

1. To access CLI via the WMI, click **CLI** under the **Tools** section on the left (for detailed instructions see “[CLI](#)” on page 427). Skip to [Step 4](#) on page 87.

To access CLI via SSH, see “[Establishing a Secure Shell \(SSH\) Connection](#)” on page 437. Then proceed to the next step.

2. At the **login as** prompt, log in to CLI using the username and password that you set in [Step 5 on page 171](#), or the default value of **admin/admin** if you have not changed them.

```
login as: jsmith
jsmith@xr4012802207c's password:

Riverbed Wi-Fi AP
ArrayOS Version 6.1.2-3299
Copyright (c) 2005-2012 Riverbed, Inc.
http://www.riverbed.com

AP42#
```

3. Type **configure** to enter the CLI config mode.

```
AP42#configure
```

4. If Xircon access at the XBL level is to be allowed, use the following three commands to change the XBL username and password from the default values of **admin/admin**. In the example below, replace **newusername** and **newpassword** with your desired entries. Note that these entries are case-sensitive.

```
AP42#(config)#boot-env
AP42#(config-boot)#set username newusername
AP42#(config-boot)#set password newpassword
AP42#(config-boot)#save
Saving boot environment.... OK
AP42(config-boot)# exit
```

5. Enter the following commands if you wish to change Xircon access permission:

```
AP42#(config)# management
AP42#(config-mgmt)# xircon <management-status>
AP42#(config-mgmt)# save
AP42#(config-mgmt)# exit
AP42#(config)#
```

<management-status> may be one of:

- **on**—enables both CLI and XBL access
- **off**—disables both CLI and XBL access
- **aos-only**—enables only CLI (i.e. ArrayOS) access

- **boot-only**—enables only XBL access

Note that there is a WMI setting for changing Xircon access, timeout period, and the UDP port used. This may be used instead of CLI if you wish. See [“Management Control” on page 243](#). Note that you cannot change the XBL username and password via the WMI.

# The Windows Management Interface

This topic provides an overview of the Riverbed Wireless AP's embedded Windows Management Interface (WMI), used for establishing your network's configuration settings and wireless operating parameters. It also includes login instructions. The following topics are discussed:

- [Managing APs Locally or Using XMS](#)
- [An Overview](#)
- [Structure of the WMI](#)
- [User Interface](#)
- [Logging In](#)
- [Applying Configuration Changes](#)

## Managing APs Locally or Using XMS

For Riverbed deployments of any size, we recommend that you use XMS to manage the network rather than directly managing each AP individually. You may change settings directly on the AP—but be aware that XMS may not sync up with these changes for up to 24 hours. All XMS versions automatically “rediscover” the wireless network once a day by default, and XMS will fetch updated settings into its database at that time. If you are an XMS-Cloud customer (XMS-9500-CL-x), you may wish to use WMI or CLI directly on the wireless device to change settings that may not be available in XMS-Cloud.

To immediately sync up XMS-Enterprise with changes that you have made to a particular AP, you may go to the XMS **Monitor > APs** or **Configure > APs** page. Select the AP, and click the **Refresh** button to update XMS with your changes on an AP. This causes XMS to read the current configuration of the AP and update the XMS database with these values.

### **IPv6**

You can manage the AP directly using IPv4 or IPv6 addressing for CLI (SSH) or WMI.

## An Overview

The WMI is an easy-to-use graphical interface to your Wireless AP. It allows you to configure the product to suit your individual requirements and ensure that the unit functions efficiently and effectively.

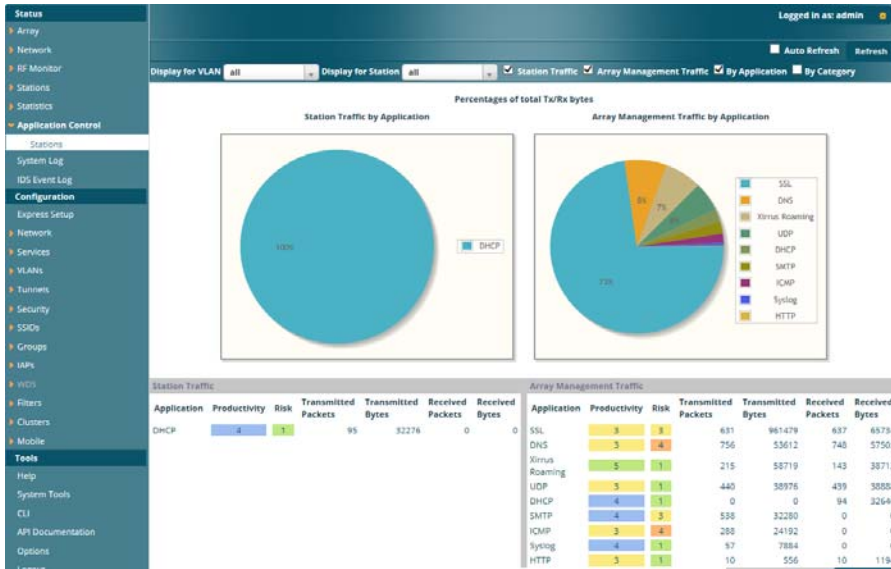

Figure 37. Windows Management Interface

## Structure of the WMI

The content of the WMI is organized by function and hierarchy, shown in the following table. Click on any item below to jump to the referenced destination.

<b>Status Windows</b> <a href="#">Access Point Status Windows</a> <a href="#">Access Point Summary</a> <a href="#">Access Point Information</a> <a href="#">Access Point Configuration</a> <a href="#">Admin History</a> <a href="#">Network Status Windows</a> <a href="#">Network Map</a> <a href="#">Spanning Tree Status</a> <a href="#">Routing Table</a> <a href="#">ARP Table</a> <a href="#">DHCP Leases</a> <a href="#">Connection Tracking/NAT</a> <a href="#">CDP List</a> <a href="#">Network Assurance</a> <a href="#">RF Monitor Windows</a> <a href="#">IAP Monitoring</a> <a href="#">Spectrum Analyzer</a> <a href="#">Rogues</a> <a href="#">Channel History</a> <a href="#">Radio Assurance</a> <a href="#">Station Status Windows</a> <a href="#">Stations</a> <a href="#">Location Map</a> <a href="#">RSSI</a> <a href="#">Signal-to-Noise Ratio (SNR)</a> <a href="#">Noise Floor</a> <a href="#">Max by IAP</a> <a href="#">Station Assurance</a>	<a href="#">Statistics Windows</a> <a href="#">IAP Statistics Summary</a> <a href="#">Per-IAP Statistics</a> <a href="#">Network Statistics</a> <a href="#">VLAN Statistics</a> <a href="#">WDS Statistics</a> <a href="#">IDS Statistics</a> <a href="#">Filter Statistics</a> <a href="#">Station Statistics</a> <a href="#">Per-Station Statistics</a> <a href="#">Application Control Windows</a> <a href="#">System Log Window</a> <a href="#">IDS Event Log Window</a>
---	--



<b>Configuration Windows</b>	<b>Configuration Windows (cont'd)</b>
Express Setup	Groups
Network	Group Management
Interfaces	IAPs
Bonds and Bridging	IAP Settings
DNS Settings	Global Settings
Cisco Discovery Protocol	Global Settings .11an
(CDP) Settings	Global Settings .11bgn
Services	Global Settings .11n
Time Settings (NTP)	Global Settings .11u
NetFlow	Global Settings .11ac
Wi-Fi Tag	Advanced RF Settings
Location	Hotspot 2.0
System Log	NAI Realms
SNMP	Intrusion Detection
DHCP Server	LED Settings
Proxy Services	DSCP Mappings
VLANs	Roaming Assist
VLAN Management	WDS
Tunnels	WDS Client Links
Tunnel Management	Filters
SSID Assignments	Filter Management
Security	Custom Application List
Admin Management	Mobile
Admin Privileges	AirWatch
Admin RADIUS	<b>Tool Windows</b>
Management Control	System Tools
Access Control List	CLI
Global Settings	API Documentation
External Radius	Options
Internal Radius	Logout
Active Directory	
Rogue Control List	
OAuth 2.0 Management	
SSIDs	
SSID Management	
Active IAPs	
Per-SSID Access Control List	
Honeypots	

## User Interface

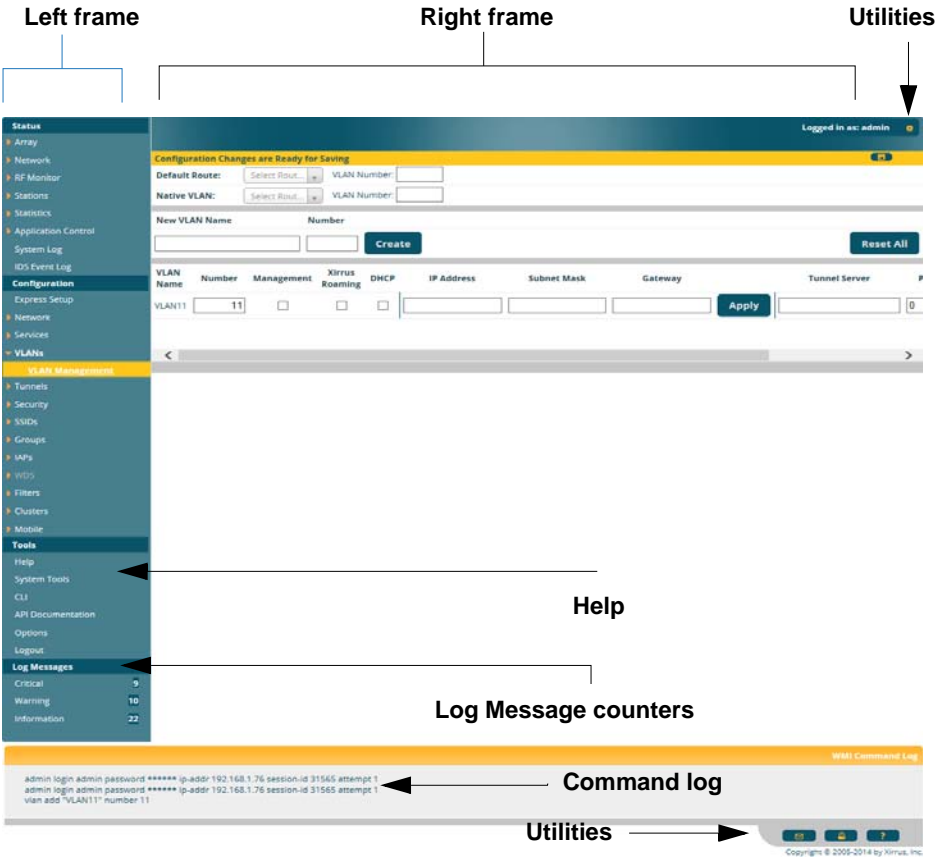

Figure 38. WMI: Frames

The WMI has been designed with simplicity in mind, making navigation quick and easy. In the following example, you'll see that windows are divided into left and right frames. (Figure 38)

The left frame contains two main elements:

- The menu is organized into three major sections (**Status**, **Configuration**, **Tools**). Each has headings for major functions, such as Network, SSIDs, Security, etc. Click a heading, such as **Network**, to display a page

showing a summary of its current configuration, as well as to show links for all of its associated WMI pages.

- Three **Log Messages** counters are located at the bottom of the menu. They provide a running total of messages generated by the ArrayOS Syslog subsystem during your session—organized into **Critical**, **Warning**, and **General** messages. Click on a counter to display the associated Syslog messages. Messages at the selected level or higher will be shown. For more information, please see “[System Log Window](#)” on page 161.

The right frame has four main elements:

- The header shows the AP type in the upper right corner, along with the hostname (this defaults to the unit’s serial number) and IP address. The Uptime shows the time since the AP was last rebooted.



*If you have added modular IAPs to your AP, note that its model number will be automatically adjusted to reflect the count and types of IAPs currently installed. See [Upgrading with 802.11ac radio modules](#).*



Below this is the page title, and the user name you used to log in. On the right, click the Utilities button  for a drop-down menu that allows you to **Refresh Page**, **Save** your changes, open the **Help** system, or **Logout**. If you have any unsaved changes, the **Save** button  is displayed on the right, in the top bar.



Figure 39. WMI Header

- The main window displays the status information or configuration page that you requested. This is where you review the AP’s current status and activity or enter changes if you wish.

- The Command Log shows the resulting commands for requests made through the WMI.

```

WMI Command L
admin login admin password ***** ip-addr 192.168.1.76 session-id 16393 attempt 1
contact-info name "Dave"
interface gig2
down

```

Figure 40. WMI Command Log

- Utility buttons are located at the bottom right of each window—a **Feedback** button, a **Print** button and a **Help** button.

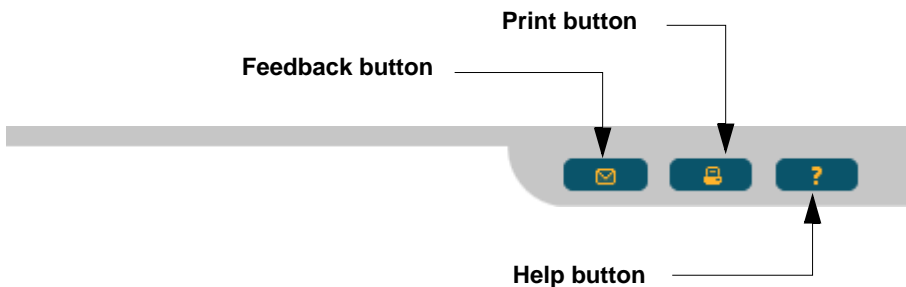

Figure 41. WMI: Utility Buttons

- Click the **Feedback** button to generate a Web page that allows you to submit your comments to Riverbed, Inc.
- Click the **Print** button to open a print dialog to send a copy of the active window to your local printer.
- Click the **Help** button to access the AP's online help system.

### *Submitting Your Comments*

When submitting comments via the Feedback button ensure that you provide as much detail as possible, including your contact information, the product model number that the comment relates to, and the ArrayOS software version (if known). When finished, click on the **Submit** button to submit your comment.



*Some pages or individual settings are only available if the AP's license includes appropriate Riverbed **Advanced Feature Sets**. If a setting is unavailable (grayed out), then your license does not support the feature. See [“About Licensing and Upgrades”](#) on page 412.*

Note that WMI provides an option that allows you to change its behavior. You may change:

- **Refresh Interval**—the refresh interval, if automatic refresh is selected.

See [“Options”](#) on page 434 for more information.

### Logging In

Use this procedure to log in to the WMI via your Web browser.

1. Establish a network connection and open your Web browser.
2. If your network supports DHCP and DNS, enter the AP's default host name in the browser's URL. The default host name is simply the AP's serial number (for example, XR0823091CACD).

Otherwise, enter the AP's IP address. This may be determined as described in [“Using the Ethernet Ports to Access the AP”](#) on page 82.

3. The default login to the AP's Windows Management Interface is **admin** for both the user name and password.



Figure 42. Logging In to the Wireless AP

## Applying Configuration Changes

In most of the WMI configuration windows, your changes to settings are applied to the AP as you make them. In most cases, there is no separate Apply button to click to make the changes take effect. There are a few exceptions to this rule. In these cases, a particular section of a page may have its own **Apply Settings** button right below the settings.

In both cases described above, the changes that you have made are not saved to the latest configuration file in the AP's flash memory, so they will not be restored after a reboot. Click the **Save** button  (located on the upper right of each page) in order to make sure that these changes will be applied after rebooting. This will save the entire current configuration, not only the changes on current WMI page.

## Character Restrictions

When inputting strings in the WMI (for example, assigning SSIDs, host name, password, etc.), use common alphanumeric characters. Some of the fields in the WMI will not accept special characters, so use of the following characters should typically be avoided:

&   <   >   '   "   /   \

# Viewing Status on the Wireless AP

These windows provide status information and statistics for your AP using the product's embedded Windows Management Interface (WMI). You cannot make [configuration changes](#) to your AP from these windows. The following topics have been organized into functional areas that reflect the [flow and content](#) of the Status section of the navigation tree in the left frame of the WMI.

- [“Access Point Status Windows” on page 100](#)
- [“Network Status Windows” on page 108](#)
- [“RF Monitor Windows” on page 119](#)
- [“Station Status Windows” on page 130](#)
- [“Statistics Windows” on page 143](#)
- [“Application Control Windows” on page 154](#)
- [“System Log Window” on page 161](#)
- [“IDS Event Log Window” on page 162](#)

Configuration and Tools windows are not discussed here. For information on these windows, please see:

- [“Configuring the Wireless AP” on page 165](#)
- [“Using Tools on the Wireless AP” on page 411](#)



*If you have added modular IAPs to your AP, note that its model number will be automatically adjusted to reflect the count and types of IAPs currently installed. See [Upgrading with 802.11ac radio modules](#).*

## Access Point Status Windows

The following AP Status windows are available:

- **Access Point Summary**—displays information on the configuration of all AP interfaces, including IAPs.
- **Access Point Information**—provides version/serial number information for all AP components.
- **Access Point Configuration**—shows all configuration information for the AP in text format.
- **Admin History**—shows all current and past logins since the last reboot.

### Access Point Summary

This is a status only window that provides a snapshot of the global configuration settings for all Wireless AP network interfaces and IAPs. You must go to the appropriate configuration window to make changes to any of the settings displayed here—[configuration changes](#) cannot be made from this window. Clicking on an interface or IAP will take you to the proper window for making configuration changes.

Ethernet Settings Summary												
Interface	State	Management	LED	Auto Neg	Link	Duplex	Speed (Mbps)	MTU Size	DHCP	IP Address	Subnet Mask	Gateway
gig1	enabled	enabled	enabled	on	up	full	1000	1500	enabled	10.100.44.37	255.255.255	10.100.44.1
gig2	enabled	enabled	enabled	on	down	full	10	1500	enabled	10.100.44.37	255.255.255	10.100.44.1

Bond Settings Summary					
Interface	Bond	Mode	Ports	Active Vlans	Mirror
gig1	bond1	link-backup	gig1 gig2	all	off
gig2	bond1	link-backup	gig1 gig2	all	off

IAP Summary														
IAP	State	AP Type	Band	WiFi Mode	Bond	Channels	Channel Mode	Antenna	Cell Size	TX Power	RX Threshold	Stations	Distance	BSSID
iap1	up	.11abgn 3x3	monitor	abgn	off	monitor	dedicated monitor	internal omni	monitor	20	-95	0		00:0f:7d:56:87:80
iap2	down	.11abgn 3x3	5GHz	an	40mhz +1	36 40	default	internal directional	max	20	-90	0		00:0f:7d:56:87:80

Network Assurances			
Setting	Hostname	IP Address	Status
DNS server 1		10.100.1.10	Connectivity OK
NTP primary server	ntp.xirus.com	108.61.73.243	Connectivity OK
SNMP trap host 1	Xirus-XMS	10.100.23.28	Connectivity OK
gig1 IP gateway		10.100.44.1	Connectivity OK
gig2 IP gateway		10.100.44.1	No connectivity

Operating Status
------------------

Figure 43. AP Summary



### Content of the Access Point Summary Window

The Access Point Summary window is sub-divided into the **Ethernet Interfaces** section and the Integrated Access Point (radio) section, providing you with the following information:

- **Ethernet Settings Summary**

This section provides information about network interface devices. To make configuration changes to these devices, go to [“Interfaces” on page 174](#).

- **Interface:** Lists the network interfaces that are available on the AP.
- **State:** Shows the current state of each interface, either enabled or disabled.
- **Mgmt:** Shows whether AP management traffic is allowed on this interface.
- **Auto Neg:** Shows whether auto-negotiation is in use on this interface, to determine settings for speed, parity bits, etc.
- **LED:** Shows whether LED display of interface status is enabled.
- **Link:** Shows whether the link on this interface is up or down.
- **Duplex:** Shows whether full duplex mode is in use.
- **Speed:** Shows the speed of this interface in Mbps.
- **MTU Size:** Shows the Maximum Transmission Unit size that has been configured. This is the largest packet size (in bytes) that the interface can pass along.
- **DHCP:** Shows whether DHCP on this port is enabled or disabled.
- **IP Address:** Shows the current IP address assigned to each network interface device.
- **Subnet Mask:** Shows the subnet mask, which defines the number of IP addresses that are available on the routed subnet where the AP is located.
- **Gateway:** Shows the IP address of the router that the AP uses to transmit data to other networks.

- **Bond Settings Summary**

This section provides information about the relationship that has been selected for the Gigabit ports. For detailed explanations and to make configuration changes, see [“Bonds and Bridging” on page 177](#).

- **Bond:** Lists all network bonds that have been configured.
- **Mode:** Shows the type of relationship that has been selected for the Gigabit ports.
- **Ports:** Shows the Gigabit ports that are part of this bond.
- **Port Mode:** Shows the relationship that has been selected for the Ethernet ports. See [“Bonds and Bridging” on page 177](#) for details
- **Active VLANs:** Shows the VLANs that are active in this bond.
- **Mirror:** Shows whether mirroring is enabled on this bond.

- **IAP Section**

This section provides information about the Integrated Access Points (IAPs) that are contained within the AP. How many IAPs are listed depends on which product model you are using. To make configuration changes to these IAPs, go to [“IAP Settings” on page 319](#).

- **IAP:** Lists the IAPs that are available on the AP.
- **State:** Shows the current state of each IAP, either up or down. IAPs that are down are shown in RED. [Figure 44](#) shows an example where **iap7** is down.
- **AP Type:** Shows the types of 802.11 clients supported by this IAP (11/a/b/g/n) and the number of separate data streams transmitted and received by the antennas of each IAP for 802.11n. For example, 3x3 means that the IAP supports three transmit chains and three receive chains. See [“Up to Eight Simultaneous Data Streams—Spatial Multiplexing” on page 48](#).

IAP Summary														
IAP	State	AP Type	Band	WiFi Mode	Bond	Channels	Channel Mode	Antenna	Cell Size	TX Power	RX Threshold	Stations	Distance	BSSID
iap1	up	.11abgn 3x3	monitor	abgn	off	monitor	dedicated monitor	internal omni	monitor	20	-95	0		00:01:7d:56:87:80
iap2	down	.11abgn 3x3	5GHz	an	40mhz +1	36 40	default	internal directional	max	20	-90	0		00:01:7d:56:87:90

Figure 44. Disabled IAP (Partial View)

- **Channel:** Shows which channel each IAP is using, and the channel setting. To avoid co-channel interference, adjacent radios should not be using adjacent channels. To make channel selections for a specific IAP, go to [“IAP Settings” on page 319](#).
- **Wi-Fi Mode:** Shows the 802.11 client types that the IAP has been configured to support.
- **Antenna:** Shows which antenna is being used by each IAP.
- **Cell Size:** Indicates which cell size setting is currently active for each IAP—small, medium, large, max, automatic, or manually defined by you.

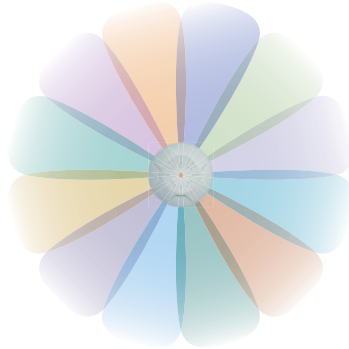

Figure 45. IAP Cells

The cell size of an IAP is a function of its transmit power and determines the IAP’s overall coverage. To define cell sizes, go to [“IAP Settings” on page 319](#). For additional information about cell sizes and the importance of planning for and defining the optimum cell sizes for your AP, go to [“Coverage and Capacity Planning” on page 38](#).

- **Tx Power:** Shows the transmit power for each IAP.

- **Rx Threshold:** Shows the receive threshold for each IAP.
  - **Stations:** Informs you how many client stations are currently associated with each IAP.
  - **WDS Link/Distance:** The WDS Link on this radio (if any), and whether the link has been set to support [Long Distance Links](#). See [“WDS” on page 391](#).
  - **MAC Address/BSSID:** Shows the MAC address for each IAP.
  - **Description:** The description (if any) that you set for this IAP.
- **Network Assurance Section**  
This section shows the results of ongoing network assurance testing. This is the same as information shown in [“Network Assurance” on page 117](#).

Network Assurances			
Setting	Hostname	IP Address	Status
DNS server 1		192.168.1.254	Connectivity OK
NTP primary server	time.nist.gov	216.171.120.36	Connectivity OK
NTP secondary server	pool.ntp.org	69.85.183.27	Connectivity OK
SNMP trap host 1	Avaya-WOS		Hostname unresolved
gig1 IP gateway		192.168.1.254	Connectivity OK
gig2 IP gateway		192.168.1.254	No connectivity

Operating Status		
Controller Temperature	Fan Speed	Compass Heading

Figure 46. Network Assurance and Operating Status

The AP checks connectivity to network servers that you have configured (for example, DNS and NTP servers) on an ongoing basis. For each Setting, this list shows the server’s **Host Name** (if any), **IP Address**, and **Status**.

Network assurance must be enabled on the AP in order to perform these connectivity tests and display this information. See [“Management Control” on page 243](#).

- **Operating Status Section**  
This section shows the AP controller board’s current internal temperatures, current fan speed, and compass heading. (Figure 46)

Notice that the Compass Heading field will only show a value if the AP model is one that includes a built-in compass. In order for this reading to be correct, the AP must be mounted with iap1 facing north. If the AP does not have an integrated compass, this field will just show a dash.

### *See Also*

[Management Control](#)

[Interfaces](#)

[Bonds and Bridging](#)

[IAP Settings](#)

[Network Assurance](#)

## Access Point Information

This is a status only window that shows you the current firmware versions utilized by the AP, serial numbers assigned to each module, MAC addresses, licensing information, and recent boot timestamps. It will also show current internal temperatures, fan speed, and compass heading if the AP model supports these features.

Notice that the **License Features** row lists the features that are supported by your AP's license. See [“About Licensing and Upgrades”](#) on page 412 and [“Advanced Feature Sets”](#) on page 25 for more information.

Logged In as: admin 			
<b>HARDWARE</b>			
Model	XR520, 512MB (300MHz)		
Interface	MAC Address(es)		
Radios	50:60:28:0a:1b:00-0a:1b:1f		
Gigabit 1	50:60:28:00:01:a9		
Component	Part Number	Serial Number	Date
System	XR520	XR502490001A9	unknown
Controller	100-0154-001.A1	0000000425	2012-Dec-03 7:40
Radio Module 1	425-0003-001.1	0100000003	2012-Dec-03 14:10
Radio Module 2	425-0004-001.1	0200000015	2012-Dec-03 19:30
<b>SOFTWARE</b>			
SCD Firmware	5.00 (Oct 1 2012), Build: 4651		
Bootloader	6.3.0 (Sep 4 2014), Build: 6170		
Radio Driver	3.1.0 (Oct 08 2014), Build: 3750		
Software Version	7.1.0 (Oct 09 2014), Build: 5138		
DPI Signature File	navl_signatures-7.1.0.tar.gz		
License Key	13BR9-FFC48-LQWG2-2J6FE		
License Features	AOS 7.1 for 2 3x3 radios + RF Performance Manager + RF Analysis Manager + RF Security Manager + Application Control + Public Safety Band + 802.11ac + 802.11n		
<b>OPERATING STATUS</b>			
Time This Boot	Fri 2014-Oct-10 19:33:24 GMT		
Time Last Boot	Fri 2014-Oct-10 19:32:07 GMT		

Figure 47. AP Information

You cannot make [configuration changes](#) in this window, but if you are experiencing issues with network services, you may want to print the content of this window for your records.

### Access Point Configuration

This is a status only window that allows you to display the configuration settings assigned to the AP, based on the following filter options:

- **Running**—displays the current configuration (the one running now).
- **Saved**—displays the saved configuration from this session.
- **Lastboot**—displays the configuration as it was after the last reboot.
- **Factory**—displays the configuration established at the factory.



```
!
configure
!
description
  hostname factoryap
  location "Anywhere, USA"
exit
!
contact-info
  name "J Smith"
  phone "212 555-1212"
  email "jsmith@xyzcorp.com"
exit
!
system-info
  ! hardware-configuration
  ! =====
  ! model: XR630, 1.0GB (400MHz)
  !
  ! component      part number      serial number    date
  !
```

Figure 48. Show Configuration

If you want to see just the differences between the Running, Saved, Lastboot, and Factory configurations, you can do this by choosing a configuration option from the **Select Config** pull-down menu then selecting an alternative configuration option from the **Select Diff** pull-down menu.

To include the default configuration settings in the output, choose the configuration then click the **Include Defaults** check box. If **Include Defaults** is disabled, then only the changes from the default configuration are shown.

## Admin History

It is useful to know who else is currently logged in to an AP while you're configuring it, or who has logged in since the AP booted. This status-only window shows you all administrator logins to the AP that have occurred since the last reboot. To determine who is currently logged in, check which entries say **active** in the **Logout Time** column.

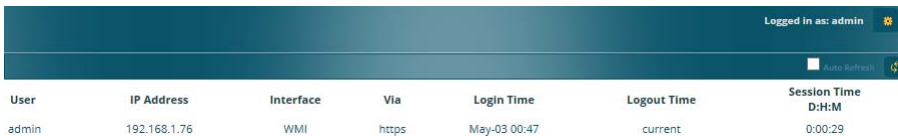

User	IP Address	Interface	Via	Login Time	Logout Time	Session Time D:H:M
admin	192.168.1.76	WMI	https	May-03 00:47	current	0:00:29

Figure 49. Admin Login History

## Network Status Windows

The following Network Status windows are available:

- **Network**—displays a summary of network interface settings.
- **Network Map**—displays information about this AP and neighboring APs that have been detected.
- **Spanning Tree Status**—displays the spanning tree status of network links on this AP.
- **Routing Table**—displays information about routing on this AP.
- **ARP Table**—displays information about Address Resolution Protocol on this AP.
- **DHCP Leases**—displays information about IP addresses (leases) that the AP has allocated to client stations.
- **Connection Tracking/NAT**—lists connections that have been established for client stations.
- **CDP List**—lists neighboring network devices using Cisco Discovery Protocol.
- **LLDP List**—lists devices on the AP's network that support the Link Layer Discovery Protocol (LLDP).



- **Network Assurance**—shows results of connectivity tests for network servers.
- **Undefined VLANs**—shows VLANs present on an 802.1Q connection to the AP, that are not configured in the AP's VLAN list.

**Network**

This window provides a snapshot of the configuration settings currently established for AP's wired interfaces. This includes the Gigabit interfaces and their bonding settings. **DNS Settings** are summarized as well. You can click on any item in the **Interface** or **Bond** columns to go to the associated configuration window.

Ethernet Settings Summary												
Interface	State	Management	LED	Auto Neg	Link	Duplex	Speed (Mbps)	MTU Size	DHCP	IP Address	Subnet Mask	Gateway
g/g1	enabled	enabled	disabled	on	up	full	1000	1500	enabled	192.168.1.2...	255.255.255...	192.168.1.2...
g/g2	enabled	enabled	disabled	on	down	full	10	1500	enabled	192.168.1.2...	255.255.255...	192.168.1.2...

Bond Settings Summary					
Interface	Bond	Mode	Ports	Active Vians	Mirror
g/g1	bond1	link-backup	g/g1 g/g2	all	off
g/g2	bond1	link-backup	g/g1 g/g2	all	off

DNS Settings Summary				
Hostname	Domain	DNS Server 1	DNS Server 2	DNS Server 3
factoryap	gateway.2wire.net	192.168.1.254		

Figure 50. Network Settings

WMI windows that allow you to change or view configuration settings associated with the network interfaces include:

- **“Interfaces” on page 174**
- **“Bonds and Bridging” on page 177**
- **“DNS Settings” on page 184**
- **“Cisco Discovery Protocol (CDP) Settings” on page 185**

## Network Map

This window offers detailed information about this AP and all neighboring APs, including how the APs have been set up within your network.

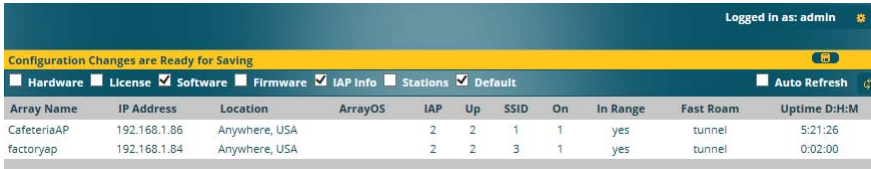

Configuration Changes are Ready for Saving in

Hardware
  License
  Software
  Firmware
  IAP Info
  Stations
  Default
  Auto Refresh ⬇

Array Name	IP Address	Location	ArrayOS	IAP	Up	SSID	On	In Range	Fast Roam	Uptime D:H:M
CafeteriaAP	192.168.1.86	Anywhere, USA		2	2	1	1	yes	tunnel	5:21:26
factoryap	192.168.1.84	Anywhere, USA		2	2	3	1	yes	tunnel	0:02:00

Figure 51. Network Map

The Network Map has a number of options at the top of the page that allow you to customize your output by selecting from a variety of information that may be displayed. You may sort the rows based on any column that has an active column header, indicated when the mouse pointer changes to the hand icon . Click **Refresh** to update the information at any time. Click **Auto Refresh** to instruct the AP to refresh this window automatically.

### Content of the Network Map Window

By default, the network map shows the following status information for each AP:

- **Access Point Name:** The host name assigned to the AP. To establish the host name, go to [“Express Setup” on page 167](#). You may click the host name to access WMI for this AP.
- **IP Address:** The AP’s IP address. You may click the address to access WMI for this AP. If DHCP is enabled, the AP’s IP address is assigned by the DHCP server. If DHCP is disabled, you must assign a static IP address. To enable DHCP or to assign a static IP address for the AP, go to [“Express Setup” on page 167](#).
- **Location:** The location assigned to the AP. To establish the location information, go to [“Express Setup” on page 167](#).
- **Array OS:** The software version running on the AP.
- **IAP:** The number of IAPs on the AP.

- **(IAP) Up:** Informs you how many IAPs are currently up and running. To enable or disable all IAPs, go to [“Express Setup” on page 167](#). To enable or disable individual IAPs, go to [“IAP Settings” on page 319](#).
- **SSID:** Informs you how many SSIDs have been assigned for the AP. To assign an SSID, go to [“SSID Management” on page 283](#).
- **(SSID) On:** Informs you how many SSIDs are enabled. To enable or disable SSIDs, go to [“SSID Management” on page 283](#).
- **In Range:** Informs you whether the AP is within wireless range of another Wireless AP.
- **Fast Roam:** Informs you whether or not the Riverbed fast roaming feature is enabled. This feature utilizes the Riverbed Roaming Protocol (XRP) ensuring fast and seamless roaming capabilities between IAPs or APs at both Layer 2 and Layer 3. To enable or disable fast roaming, go to [“Global Settings” on page 325](#).
- **Uptime (D:H:M):** Informs you how long the AP has been up and running (in Days, Hours and Minutes).

To see additional information, select from the following checkboxes at the bottom of the page. This will show the columns described below.

### *Hardware*

- **Model:** The model number of each AP, plus the amount of RAM memory and the speed of the processor.
- **Serial:** Displays the serial number of each AP.

### *License*

- **License:** The license key of each AP.
- **Licensed Features:** Lists the features enabled by the key.

### *Software (enabled by default)*

- Enable/disable display of the AP OS column.

### *Firmware*

- **Boot Loader:** The software version number of the boot loader on each AP.

- **SCD Firmware:** The software version number of the SCD firmware on each AP.

*IAP Info (enabled by default)*

- Enable/disable display of the IAP/Up columns.

*Stations*

- **Stations:** Tells you how many stations are currently associated to each AP. To de-authenticate a station, go to [“Stations” on page 131](#).

The columns to the right (**H**, **D**, **W**, and **M**) show the highest number of stations that have been associated over various periods of time: the previous hour, day, week, and month.

*Default*

- Sets the columns displayed to the default settings. By default, only Software and IAP Info are selected.

### Spanning Tree Status

Multiple active paths between stations can cause loops in the network. If a loop exists in the network topology, the potential exists for the duplication of messages. The spanning tree protocol is a link management protocol that provides path redundancy while preventing undesirable loops. For a wireless network to function properly, only one active path can exist between two stations.

To facilitate path redundancy, the spanning tree protocol defines a tree that spans all stations in the network and forces certain redundant data paths into a standby (blocked) state. If one segment in the spanning tree becomes unreachable, the spanning tree algorithm reconfigures the network topology and reestablishes the link by activating the standby path. The spanning tree function is transparent to client stations.

VLAN Name	Number	Gigabit 1	Gigabit 2	WDS Client Links				WDS Host Links		
				1	2	3	4	1	2	3
none		forwarding	forwarding	forwarding						
VLAN11	11	forwarding	forwarding	forwarding						

Figure 52. Spanning Tree Status

This window shows the spanning tree status (forwarding or blocked) for path segments that terminate on the Gigabit ports and WDS links of this AP. You may sort the rows based on the **VLAN Name** or **Number** columns by clicking the column header. Click **Refresh** to update the information at any time. Click **Auto Refresh** to instruct the AP to refresh this window automatically.

*See Also*

[Network](#)

[Interfaces](#)

[Network Status Windows](#)

[VLANs](#)

[WDS](#)

## Routing Table

This status-only window lists the entries in the AP's routing table. The table provides the AP with instructions for sending each packet to its next hop on its route across the network.

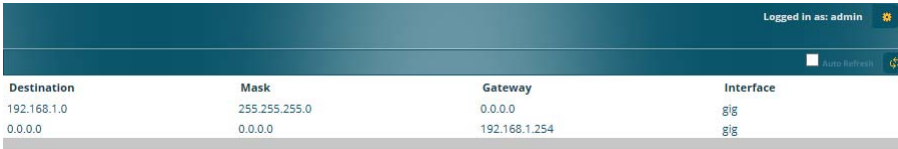

Destination	Mask	Gateway	Interface
192.168.1.0	255.255.255.0	0.0.0.0	g/g
0.0.0.0	0.0.0.0	192.168.1.254	g/g

Figure 53. Routing Table

### See Also

#### VLANs

#### Configuring VLANs on an Open SSID

## ARP Table

This status-only window lists the entries in the AP's ARP table. For a device with a given IP address, this table lists the device's MAC address. It also shows the AP interface through which this device may be reached. The table typically includes devices that are on the same local area network segment as the AP.



Select	IP Address	MAC Address	Interface
<input checked="" type="checkbox"/>	192.168.1.254	ac:5d:10:3c:15:81	g/g
<input checked="" type="checkbox"/>	192.168.1.76	8c:89:a5:10:4f:c4	g/g
<input checked="" type="checkbox"/>	192.168.1.83	00:0c:29:1e:46:f7	g/g
<input checked="" type="checkbox"/>	192.168.1.86	50:60:28:02:61:6c	g/g

Figure 54. ARP Table

### See Also

#### Routing Table

#### ARP Filtering

### DHCP Leases

This status-only window lists the IP addresses (leases) that the AP has allocated to client stations. For each, it shows the IP address assigned from one of the defined DHCP pools, and the MAC address and host name of the client station. The start and end time of the lease show how long the allocation is valid. The same IP address is normally renewed at the expiration of the current lease.

IP Address	MAC Address	Start Time	End Time	Time Left	Host Name
No DHCP Leases					

Figure 55. DHCP Leases

*See Also*  
[DHCP Server](#)

### Connection Tracking/NAT

This status-only window lists the session connections that have been created on behalf of clients. This table may also be used to view information about current NAT sessions.

Outbound Traffic										Return Traffic					
Type	State	Source IP	Destination IP	Src Port	Dst Port	Packets	Bytes	State	Source IP	Destination IP	Src Port	Dst Port	Packets	Bytes	
udp		192.168.1.84	69.25.96.13	123	123	51	3876	Assured	69.25.96.13	192.168.1.84	123	123	50	3800	
tcp	Established	192.168.1.78	198.38.97.144	61841	80	2013	84045	Assured	198.38.97.144	192.168.1.78	80	61841	3904	5844241	
udp		192.168.1.72	239.255.255.250	1054	8082	1181	581052	Unreplied	239.255.255.250	192.168.1.72	8082	1054	0	0	
tcp	Established	192.168.1.78	184.87.194.107	61845	80	7	1360	Assured	184.87.194.107	192.168.1.78	80	61845	6	1157	
tcp	Established	192.168.1.78	54.225.246.154	61846	443	12	7156	Assured	54.225.246.154	192.168.1.78	443	61846	12	7405	
tcp	Time Wait	192.168.1.76	192.168.1.84	63962	443	11	1287	Assured	192.168.1.84	192.168.1.76	443	63962	9	926	
tcp	Established	192.168.1.78	198.38.97.144	61813	80	133779	5659505	Assured	198.38.97.144	192.168.1.78	80	61813	256098	383098313	
udp		192.168.1.78	192.168.1.254	63021	53	1	70		192.168.1.254	192.168.1.78	53	63021	1	70	
udp		192.168.1.78	192.168.1.254	50263	53	1	69		192.168.1.254	192.168.1.78	53	50263	1	164	
tcp	Time Wait	192.168.1.76	192.168.1.84	63963	443	15	1383	Assured	192.168.1.84	192.168.1.76	443	63963	15	14786	
udp		192.168.1.67	239.255.255.250	1041	8082	1181	669627	Unreplied	239.255.255.250	192.168.1.67	8082	1041	0	0	
udp		192.168.1.78	192.168.1.255	17500	17500	1	219	Unreplied	192.168.1.255	192.168.1.78	17500	17500	0	0	

Figure 56. Connection Tracking

Click the **Show Hostnames** checkbox at the top of the page to display name information (if any) for the source and destination location of the connection. The Hostname columns will replace traffic statistics columns.

You may sort the rows based on any column that has an active column header, indicated when the mouse pointer changes to the hand icon . Click **Refresh** to update the information at any time. Click **Auto Refresh** to instruct the AP to refresh this window automatically.

*See Also*

Filters

### CDP List

This status-only window lists devices on the AP's network that support the Cisco Discovery Protocol (CDP).

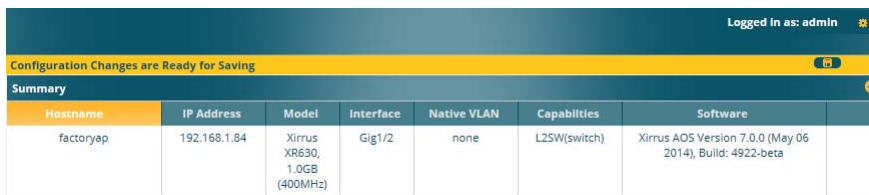

Hostname	IP Address	Model	Interface	Native VLAN	Capabilities	Software
factoryap	192.168.1.84	Xirrus XR630, 1.0GB (400MHz)	Gig1/2	none	L2SW[switch]	Xirrus AOS Version 7.0.0 (May 06 2014), Build: 4922-beta

Figure 57. CDP List

The AP performs discovery on the network on an ongoing basis. This list shows the devices that have been discovered—Cisco devices and other devices on the network that have CDP running. For each, it shows the device's host name, IP address, manufacturer and model name, the device interface that is connected to the network (i.e., the port that was discovered), and the network capabilities of the device (switch, router, supported protocols, etc.).

CDP must be enabled on the AP in order to gather and display this information. For details and some restrictions, see [“Cisco Discovery Protocol \(CDP\) Settings” on page 185](#).



### LLDP List

This status-only window lists devices on the AP’s network that support the Link Layer Discovery Protocol (LLDP).

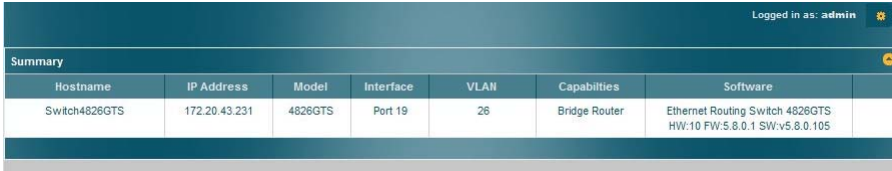

Hostname	IP Address	Model	Interface	VLAN	Capabilities	Software
Switch4826GTS	172.20.43.231	4826GTS	Port 19	26	Bridge Router	Ethernet Routing Switch 4826GTS HW:10 FW:5.8.0.1 SW:v5.8.0.105

Figure 58. LLDP List

The AP performs discovery on the network on an ongoing basis. This list shows the devices that have been discovered—devices on the network that have LLDP running. For each, it shows the device’s host name, IP address, and model name, the device interface that is connected to the network (i.e., the port that was discovered), and the network capabilities of the device (switch, router, supported protocols, etc.).

LLDP must be enabled on the AP in order to gather and display this information. For details and some restrictions, see “LLDP Settings” on page 186.

### Network Assurance

This status-only window shows the results of ongoing network assurance testing.



Setting	Hostname	IP Address	Status
DNS server 1		192.168.1.254	Connectivity OK
RADIUS primary server	Radius1		Hostname unresolved
RADIUS secondary server	Radius2		Hostname unresolved
SNMP trap host 1	Xirrus-XMS		Hostname unresolved
Syslog email server	mail.xyzcorp.com	23.23.139.88	No connectivity
Syslog primary server		192.168.1.111	No connectivity
Syslog secondary server		192.168.1.112	No connectivity

Figure 59. Network Assurance

The AP checks connectivity to network servers that you have configured (for example, DNS and NTP servers) on an ongoing basis. For each server, this list shows the server’s host name (if any), IP address, and status.

Network assurance must be enabled on the AP in order to perform these connectivity tests and display this information. See [“Management Control”](#) on page 243.

*See Also*

[Management Control](#)

### Undefined VLANs

This status-only window lists VLANs that are detected on the AP’s trunk ports (i.e., wired ports), but have not been configured on the AP. See [“VLANs”](#) on page 217.

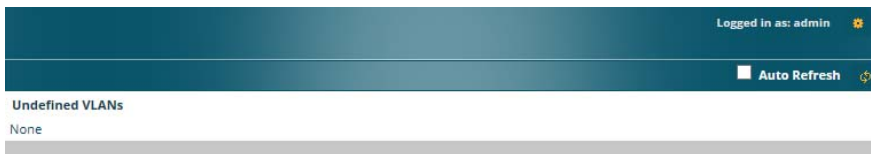

Figure 60. Undefined VLANs

This feature alerts you to the fact that an 802.1Q trunk to the AP has VLANs that are not being properly handled on the AP. To reduce unnecessary traffic, only VLANs that are actually needed on the AP should normally be on the trunk, e.g., the management VLAN and SSID VLANs. In some cases such as multicast forwarding for Apple Bonjour you may want to extend other VLANs to the AP, in order to forward Bonjour or other multicast packets (see [“Advanced Traffic Optimization”](#) on page 330).

*See Also*

[VLANs](#)

## RF Monitor Windows

Every Wireless AP includes an integrated RF spectrum analyzer as a standard feature. The spectrum analyzer allows you to characterize the RF environment by monitoring throughput, signal, noise, errors, and interference levels continually per channel. This capability uses the assigned threat-sensor (monitor) radio. The associated software is part of the ArrayOS.

The following RF Status windows are available:

- **IAP Monitoring**—displays current statistics and RF measurements for each of the AP's IAPs.
- **Spectrum Analyzer**—displays current statistics and RF measurements for each of the AP's channels.
- **Rogues**—displays rogue APs that have been detected by the AP.
- **Channel History**—charts ongoing statistics and RF measurements for one selected channel over time.
- **Radio Assurance**—displays counts of types of problems that caused each IAP to reset.



*We recommend using **iap1** for monitoring on AP models with up to four radios, as this radio assignment results in the best overall traffic throughput for the AP. See “IAP Settings” on page 319.*

### IAP Monitoring

The RF Monitor—IAP Monitoring window displays traffic statistics and RF readings observed by each AP IAP (radio). Note that the data is an instantaneous snapshot for the IAP—it is not an average or a cumulative total. To graph these values over time for a particular channel, see “Channel History” on page 126. For detailed information on the measurements displayed, please see “Spectrum Analyzer Measurements” on page 123.



Figure 61. RF Monitor—IAPs

Figure 61 presents the data as a graphical display, enabled by selecting the **Graph** checkbox on the upper left. If this option is not selected, data is presented as a numerical table.

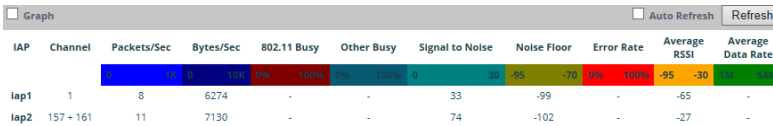



Figure 62. RF Monitor—IAPs

You may sort the rows based on any column that has an active column header, indicated when the mouse pointer changes to the hand icon . Click **Refresh** to update the information at any time. Click **Auto Refresh** to instruct the AP to refresh this window automatically.

## Spectrum Analyzer



*The RF measurements for this feature are obtained by the monitor radio. You **must** have a radio set to **monitor** mode for any data to be available. See “IAP Settings” on page 319.*



*Spectrum Analysis is not available for APs or Access Points featuring 802.11ac IAPs.*

Spectrum analysis on Wireless APs is a distributed capability that automatically covers the entire wireless network, since a sensor is present in every unit. APs monitor the network 24/7 and analyze interference anywhere in the network from your desk. There’s no need to walk around with a device as with traditional spectrum analyzers, thus you don’t have to be in the right place to find outside sources that may cause network problems or pose a security threat. The AP monitors all 802.11 radio bands (a/b/g/n), not just those currently used for data transmission.

The RF Spectrum Analyzer window displays instantaneous traffic statistics and RF readings for all channels, as measured by the AP’s monitor radio. This differs from the RF Monitor-Radio Monitoring window, which displays values measured by each IAP for its current assigned channel. For the spectrum analyzer, the monitor radio is in a listen-only mode, scanning across all wireless channels. Each channel is scanned in sequence, for a 250 millisecond interval per channel. The spectrum analyzer window presents the data as a graphical display of vertical bar graphs for each statistic as shown in [Figure 63](#) (the default presentation), or horizontally as bar graphs or numerical RF measurements. The measurements displayed are explained in “[Spectrum Analyzer Measurements](#)” on page 123.

As an aid to viewing data for a particular channel, click the channel number. The channel will be highlighted down the page (or across the page for a rotated view, in both text and graph modes). Click additional channels to highlight them for easy comparison. To remove the highlighting from a channel, click the channel number again. Click **Refresh** to update the information at any time. Click **Auto Refresh** to instruct the AP to refresh this window automatically.

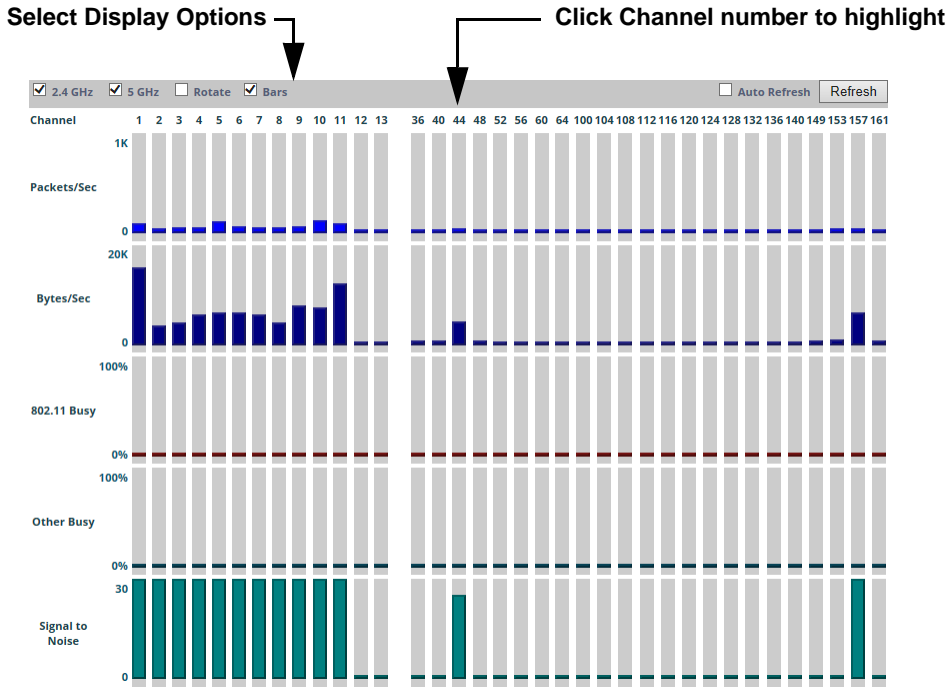



Figure 63. RF Spectrum Analyzer

The Spectrum Analyzer offers several display options:

- To display horizontal bar graphs, click the **Rotate** checkbox at the bottom of the data window.
- In the rotated view, if you wish to view data as a numerical table, click the **Text** checkbox. Click again to return to a graphical display. The text option is only available in the rotated view.
- When viewing a graphical display, click **Bars** to have the bar graphs displayed against a gray background—you may find this easier on the eyes. This operation is not available when Text is selected.
- You may sort the rows based on any column that has an active column header, indicated when the mouse pointer changes to the hand icon . Sorting is only available in the rotated view.

- At the bottom left of the frame, you may select whether to display only 2.4 GHz channels, 5 GHz channels, or both (the default is both). Note that the data is an instantaneous snapshot—it is not an average or a cumulative total.

### *Spectrum Analyzer Measurements*

The spectrum analyzer displays the following information:

- **Packets/Sec:** Total number of wireless packets per second on the channel, both valid and errored packets.
- **Bytes/Sec:** Total number of wireless bytes per second on the channel, valid packets only.
- **802.11 Busy:** Percentage of time that 802.11 activity is seen on the channel.
- **Other Busy:** Percentage of time that the channel is unavailable due to non-802.11 activity.

The total busy time (802.11 Busy plus Other Busy) will never total more than 100%. The remaining time (100% minus total busy time) is quiet time—the time that no activity was seen on the channel.

- **Signal to Noise:** Average SNR (signal to noise ratio) seen on the channel, calculated from the signal seen on valid 802.11 packets less the noise floor level. A dash value “-” means no SNR data was available for the interval.
- **Noise Floor:** Average noise floor reading seen on the channel (ambient noise). A dash value “-” means no noise data was available for the interval.
- **Error Rate:** Percentage of the total number of wireless packets seen on the channel that have CRC errors. The Error rate percentage may be high on some channels since the monitor radio is set to receive at a very sensitive level, enabling it to hear packets from devices at far distances.
- **Average RSSI:** Average RSSI level seen on 802.11 packets received on the channel. A dash value “-” means no RSSI data was available for the interval.
- **Average Data Rate:** Average data rate over time (per byte, not per packet) seen on 802.11 packets received on the channel. A dash value “-” means

no data rate information was available for the interval. A higher data rate (above 6 Mbps) typically indicates user data traffic on the channel. Otherwise, the data rate reflects control packets at the lower basic rates.

## Rogues

This window displays all detected access points, according to the classifications you select from the checkboxes at the top—**Blocked**, **Unknown**, **Known**, or **Approved**. This includes ad hoc access points (station-to-station connections). For more information about intrusion detection, rogue APs, and blocking, please see [“About Blocking Rogue APs” on page 381](#).

**Classify APs** →

**Select APs to Display** →

Select	BSSID	SSID	Manufacturer	Channel	RSSI	Security	Type	Status	Discovered	Last Active
<input type="checkbox"/>	00:1c:10:2c:0d:e0	iksys	Linksys	6	-89	none	ESS	unknown	May-08 18:25	active
<input type="checkbox"/>	24:76:7d:ef:77:8a	sco_7DEF7789	Spvtg	157	-21	AES+PSK	ESS	unknown	May-08 18:20	active

Figure 64. Intrusion Detection/Rogue AP List

The Intrusion Detection window provides the easiest method for classifying rogue APs as Blocked, Known, Approved, or Unknown. Choose one or more APs using the checkbox in the **Select** column, then use the buttons on the upper left to classify them with the following actions: **Approve**, **Set Known**, **Block**, or **Set Unknown**.

You can sort the results based on the following parameters by clicking the desired column header:

- SSID
- BSSID
- Manufacturer
- Channel
- RSSI
- Security
- Type
- Status
- Discovered
- Last Active



## Wireless Access Point

---

You can refresh the list at any time by clicking on the **Refresh** button, or click in the **Auto Refresh** check box to instruct the AP to refresh the list automatically.

### *See Also*

[Network Map](#)

[Rogue Control List](#)

[SSIDs](#)

[SSID Management](#)

## Channel History



*Channel History is not available for APs or Access Points featuring 802.11ac IAPs.*

The RF Monitor—Channel History window focuses on traffic statistics and RF readings observed for just one channel that you select in the **Channel** field. A new set of readings is added every 10 seconds for a 5 GHz channel, or every 5 seconds for a 2.4 GHz channel. For descriptions of the measurements displayed, please see “Spectrum Analyzer Measurements” on page 123.

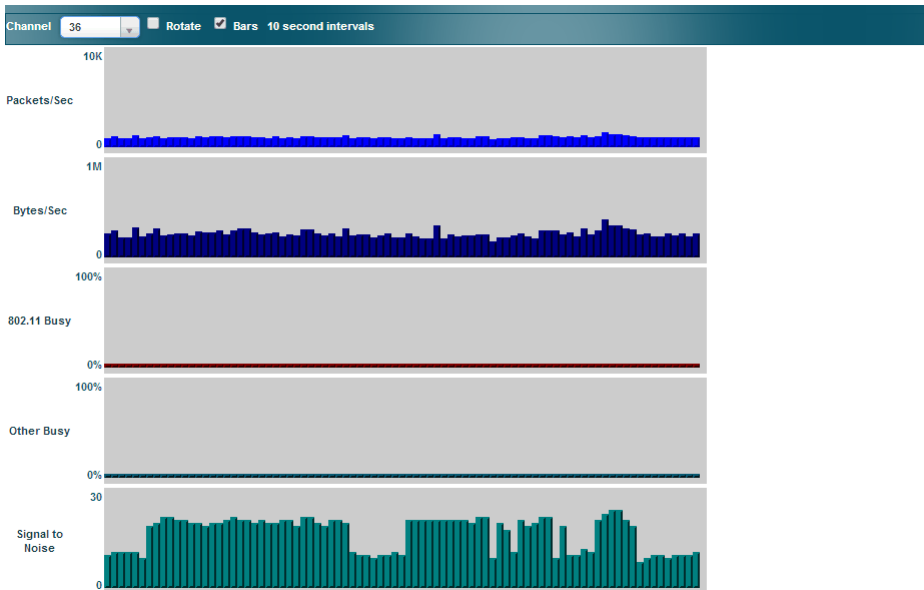

Figure 65. RF Monitor—Channel History

Figure 65 presents the data in graphical form. New data appears at the left, with older readings shifting to the right. To make the data appear as a bar chart, click the **Bar** checkbox which will shade the background.

You also have the option of clicking the **Rotate** checkbox to give each statistic its own column. In other words, the graph for each statistic will grow down the page as new readings display at the top. (Figure 66)

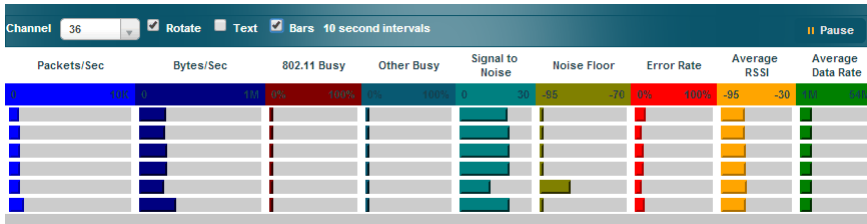

Figure 66. RF Monitor—Channel History (Rotated)

If you select **Rotate** and **Text** together, data is presented as a numerical table. (Figure 67)

Click **Pause** to stop collecting data, or **Resume** to continue.

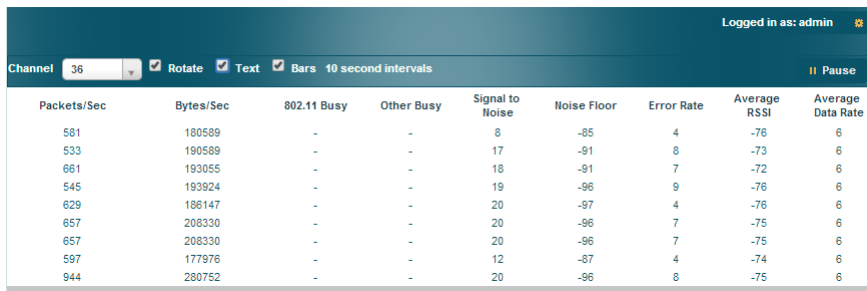

Figure 67. RF Monitor—Channel History (Text)

## Radio Assurance

When Radio Assurance mode is enabled, the monitor radio performs loopback tests on the AP's radios. When problems are encountered, the AP can take various actions to correct them by performing different levels of reset on the affected radio. This window shows which resets, if any, have been performed on which radios since the last reboot.

The AP's response to radio problems is controlled by the **Radio Assurance Mode** selected, as described in [“RF Resilience” on page 366](#). If you have selected **Failure Alerts & Repairs** (with or without reboots), then the AP can take corrective action if a problem is detected. Note that radio assurance requires RF Monitor Mode to be enabled in [Advanced RF Settings](#) to turn on self-monitoring functions. It also requires a radio to be set to monitoring mode. For a detailed discussion of the operation of this feature and the types of resets performed, see [“Radio Assurance” on page 542](#).

IAP	State	AP Type	Channel	WiFi Mode	Monitor	IAP Reset Counts by Type			Sy
						Beacon	Phy	MAC	
iap1	up	.11abgnac 3x3	1	bgn	0	0	0	0	
iap2	up	.11abgnac 3x3	mon	abgnac	0	0	0	0	

Figure 68. Radio Assurance

For each of the AP's radios, this window shows the radio's state, its type (IEEE 802.11 type, and antenna type—2x2 or 3x3), the assigned channel, and the selected 802.11 wireless mode. To the right, the table shows counts for the number of times, if any, that radio assurance has performed each of the following types of resets since the last reboot, as described in [Radio Assurance](#):

- Monitor
- Beacon
- Phy
- MAC
- System (i.e., reboot the AP)

*See Also*

IAPs

Riverbed Advanced RF Analysis Manager (RAM)

RF Resilience

Radio Assurance



## Station Status Windows

The following Station Status windows are available:

- **Stations**—this list describes all stations associated to the AP.
- **Location Map**—displays a map showing the approximate locations of all stations associated to the AP.
- **RSSI**—for each associated station, this displays the Received Signal Strength Indicator at each of the AP's IAPs.
- **Signal-to-Noise Ratio (SNR)**—for each associated station, this displays the SNR at each of the AP's IAPs.
- **Noise Floor**—for each associated station, this displays the ambient noise (silence) value at each of the AP's IAPs.
- **Max by IAP**—for each IAP, this shows the historical maximum number of stations that have been associated to it over various periods of time.
- **Station Assurance**— displays stations that are having connectivity problems.

## Stations

This window shows client stations currently visible to the AP. You may choose to view only stations that have **Associated** to the AP, or include stations that are **Unassociated** by selecting the appropriate buttons above the list. The list always shows the MAC address of each station, its IP address, the SSID used for the association, the **Group** (if any) that this station belongs to, its VLAN, its QoS, the IAP used for the association, transmit and receive rates, the **RSSI** for each station, and how long each association has been active (up time).

In the Link column, click the details button  to jump to a detailed statistics page for this station. Click  to see Application Control information.

You may click other buttons above the list to show a number of additional columns:

- **Identification:** shows more identifying information for the station—its **User Name**, **Host Name**, **Manufacturer**, **Device Type**, and **Device Class** (for example, notebook, iPad, etc.).
- **Security:** includes security settings used by the connection—**Encryption** type, **Cipher** used, and **Key Management** used by the station.
- **Connection Info:** shows the **Band** (5GHz or 2.4 GHz) used. Shows an additional RF measurement that affects the quality of the connection: **SNR** (signal to noise ratio).
- **Reset:** click this button to return the display to showing just the default columns.

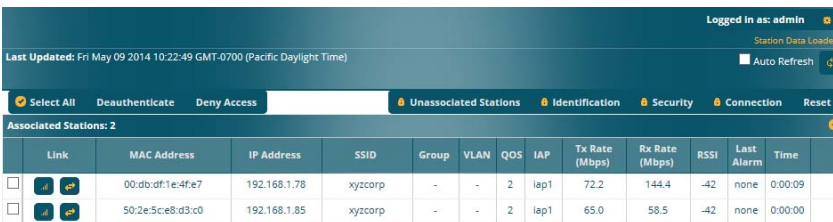





	Link	MAC Address	IP Address	SSID	Group	VLAN	QoS	IAP	Tx Rate (Mbps)	Rx Rate (Mbps)	RSSI	Last Alarm	Time
<input type="checkbox"/>	 	00:db:df:1e:4fe7	192.168.1.78	xyzcorp	-	-	2	lap1	72.2	144.4	-42	none	0:00:09
<input type="checkbox"/>	 	50:2e:5c:e8:d3:c0	192.168.1.85	xyzcorp	-	-	2	lap1	65.0	58.5	-42	none	0:00:00

Figure 69. Stations

You may sort the rows based on any column that has an active column header. Click again to reverse the sort order. You may select one or more specific stations and perform one of the following actions by clicking the associated button:

- **Deny Access:** Sends a de-authentication frame to the selected station and explicitly denies it access by adding its MAC address to the Deny List in the Access Control List window. To permit access again, go to [“Access Control List” on page 253](#) and delete the station from the **Deny** list.
- **Deauthenticate:** Sends a de-authentication frame to the selected station. The station may re-authenticate. See also, the CLI command [“clear” on page 459](#).

Click on the **Refresh** button to refresh the station list, or click in the **Auto Refresh** check box to instruct the AP to refresh this window automatically.

*See Also*

[Access Control List](#)

[Station Status Windows](#)

[Station Statistics](#)



### Location Map

The Location Map shows the approximate locations of stations relative to this AP. The location of each station is computed based on the RSSI of its signal as received by the AP. The distance is adjusted based on the environment setting that you selected. You may display just the stations associated to this AP, unassociated stations (shown in gray), or both. The station count is shown on the right, above the map. You may also choose to display only 5 GHz stations (shown in orange) or 2.4 GHz stations (shown in green), or both.

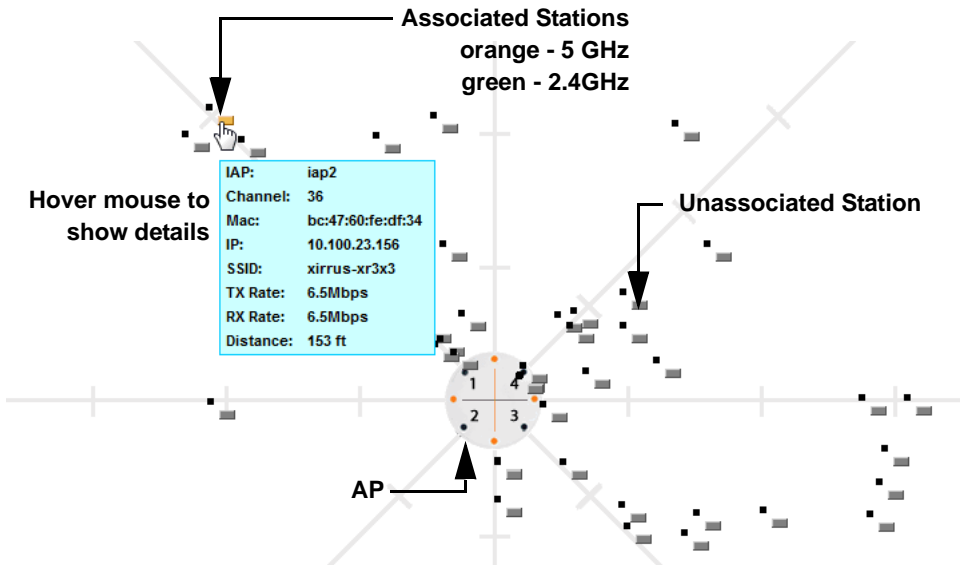

Figure 70. Location Map

The map and AP are shown as if you were looking down on the AP from above, say from a skylight on the roof. Thus the positions of the radios are a mirror image of the way they are typically drawn when looking at the face of the AP. Radios are marked on the map to show the orientation of the AP.

A station is identified by the type of **Preferred Label** that you select: **Netbios Name**, **IP Address**, **MAC Address**, or **Manufacturer**. If multiple stations are near each other, they will be displayed slightly offset so that one station does not

completely obscure another. You may minimize a station that is not of interest by clicking it. There is also a **Minimize All** button.

You may replace the range-finder background image above with your own custom image of the floor plan of the area served by the AP—see “[Working with the Custom Image](#)” on page 136

Hover the mouse over a station to show detailed information. (Figure 70) For a station that is associated to this AP, the details include:

- The **IAP**, **Channel**, and **SSID** to which the station is associated.
- The **MAC** and **IP** address and **Netbios** name of the station.
- The **TX Rate** and **RX Rate** of this connection.
- The approximate **Distance** of this station from the AP. The distance is estimated using the received signal strength and your environment setting. The environment determines the typical signal attenuation due to walls and other construction that affect signal reception.

### Controls and items displayed on the Location Map window



*The Location Map has its own scroll bars in addition to the browser's scroll bars. If you narrow the browser window, the map's scroll bar may be hidden. Use the browser's bottom scroll bar if you need to move it into view.*

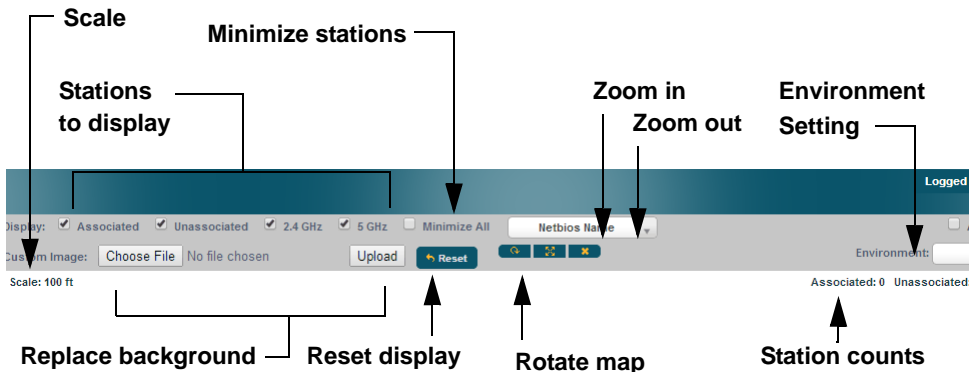





Figure 71. Controls for Location Map

- **Display Associated/Unassociated:** Select whether to display stations that are associated to the AP, stations that are not associated, or both.
- **Display 2.4 GHz/5 GHz:** Select whether to display 802.11bgn stations, or 802.11an stations, or both.
- **Preferred Label:** This field is located on the top of the window towards the right. It shows the type of label to be displayed for stations: NetBIOS is the default, else, an IP or MAC address will be used, in that order.
- **Auto Refresh:** Instructs the AP to refresh this window automatically.
- **Refresh:** Updates the stations displayed.
  
- **Custom Image:** Use this feature to replace the default background image with your own image of the floor plan of your location. Click the **Browse** button and browse to the desired file on your computer. This may be a .gif, .jpg, .jpeg, .png, .htm, or .html file. The scale of the file should be 100 feet per inch. Then click **Upload** (see below). For more information on using the custom, image, see [“Working with the Custom Image” on page 136](#).
- **Upload:** After browsing to the desired custom image, click the **Upload** button to install it. The map is redisplayed with your new background. No hash marks (for the map scale) are added to the image display.
- **Reset:** Click this button to restore the map display to the factory settings. All attributes are restored—including the stations selected for display, the scale, the rotation, and the background map.
-  **Rotate:** Click this button to rotate the orientation of the entire map. It rotates the map 45° counter-clockwise.
-  **Enlarge:** Click this button to enlarge (zoom in on) the map. The displayed **Scale** is updated with the new scale for the map.
-  **Reduce:** Click this button to reduce (zoom out on) the map. The displayed **Scale** is updated with the new scale for the map.
- **Environment:** This field is located on the top right of the window. Select the type of environment for this AP's deployment: **Indoor open** (few walls or obstructions), **Indoor walled** (typical wall or cubicle

construction), or **Indoor dense** (many walls or obstructions, or unusually dense walls).

- **Scale:** This view-only value shows the approximate distance represented by each hash mark on the default map background.
- **Associated, Unassociated, Total Stations:** These view-only values show the station counts observed by the AP.

### See Also

#### Station Status Windows

#### Working with the Custom Image

After you have uploaded a custom image (see **Custom Image** and **Upload** in “Controls and items displayed on the Location Map window” on page 134), you should move the display of the AP on your map to correspond with its actual location at your site.

To move the AP on the map, simply click it, then drag and drop it to the desired location. The AP will continue to follow the mouse pointer to allow you to make further changes to its location. When you are satisfied with its location, click the AP again to return to normal operation.

### RSSI

For each station that is associated to the AP, the RSSI (Received Signal Strength Indicator) window shows the station’s RSSI value as measured by each IAP. In other words, the window shows the strength of the station’s signal at each radio. You may choose to display **Unassociated Stations** as well with a checkbox at the bottom of the window.

<input type="checkbox"/> Colorize Intensity <input type="checkbox"/> Graph <input type="checkbox"/> Unassociated Stations		<input type="checkbox"/> Auto Refresh		Refresh	
User Name	MAC Address	Netbios Name	IP Address	Iap1	Iap2
	00:db:df:1e:4fe7		192.168.1.78	-49	-59
	50:2e:5ce8:d3:c0		192.168.1.85	-46	-56

Figure 72. Station RSSI Values

By default, the RSSI is displayed numerically. You may display the relative strength using color if you select **Colorize Intensity**, with the strongest signals indicated by the most intense color. (Figure 72) If you select **Graph**, then the RSSI

is shown on a representation of the AP, either colored or numerically based on your selection. (Figure 73) The stations are listed to the left of the AP—click on a station to show its RSSI values on the AP.

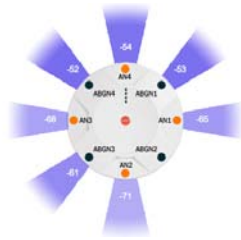



Figure 73. Station RSSI Values—Colorized Graphical View

In either graphical or tabular view, you may sort the rows based on any column that has an active column header, indicated when the mouse pointer changes to the hand icon . Click on the **Refresh** button to refresh the station list, or click in the **Auto Refresh** check box to instruct the AP to refresh this window automatically.

### *See Also*

[Station Status Windows](#)  
[RF Monitor Windows](#)

## Signal-to-Noise Ratio (SNR)

For each station that is associated to the AP, the Signal-to-Noise Ratio (SNR) window shows the station's SNR value as measured by each IAP. In other words, the window shows the SNR of the station's signal at each IAP. The signal-to-noise ratio can be very useful for determining the cause of poor performance at a station. A low value means that action may need to be taken to reduce sources of noise in the environment and/or improve the signal from the station.

<input type="checkbox"/> Colorize Intensity <input type="checkbox"/> Graph <input type="checkbox"/> Unassociated Stations <input type="checkbox"/> Auto Refresh            Refresh					
User Name	MAC Address	Netbios Name	IP Address	iap1	iap2
	00:db:df:1e:4fe7	DSCHNEIDER_DELL	192.168.1.78	48	39
	50:2e:5c:e8:d3:c0		192.168.1.85	30	38

Figure 74. Station Signal-to-Noise Ratio Values

You may choose to display **Unassociated Stations** as well with a checkbox at the bottom of the window.

By default, the SNR is displayed numerically. (Figure 74) You may display the relative value using color if you select **Colorize Intensity**, with the highest SNR indicated by the most intense color. (Figure 75) If you select **Graph**, then the SNR is shown on a representation of the AP, either colorized or numerically based on your selection. The stations are listed to the left of the AP—click on a station to show its SNR values on the AP.

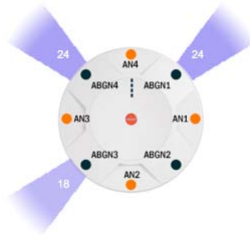



Figure 75. Station SNR Values—Colorized Graphical View

In either graphical or tabular view, you may sort the rows based on any column that has an active column header, indicated when the mouse pointer changes to

the hand icon . Click on the **Refresh** button to refresh the station list, or click in the **Auto Refresh** check box to instruct the AP to refresh this window automatically.

### See Also

[Station Status Windows](#)

[RF Monitor Windows](#)

## Noise Floor

For each station that is associated to the AP, the Noise Floor window shows the ambient noise affecting a station's signal as measured by each IAP. The noise floor is the RSSI value when the station is not transmitting, sometimes called a Silence value. In other words, the window shows the noise floor of the station's signal at each IAP. The noise floor value can be very useful for characterizing the environment of a station to determine the cause of poor performance. A relatively high value means that action may need to be taken to reduce sources of noise in the environment.

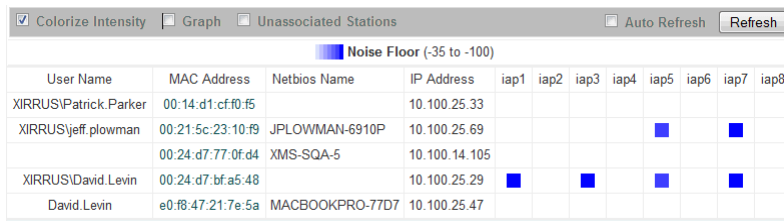

User Name	MAC Address	Netbios Name	IP Address	iap1	iap2	iap3	iap4	iap5	iap6	iap7	iap8
XIRRUS\Patrick.Parker	00:14:d1:cf:f0:f5		10.100.25.33								
XIRRUS\jeff.plowman	00:21:5c:23:10:f9	JPLOWMAN-6910P	10.100.25.69					■		■	
	00:24:d7:77:0f:d4	XMS-SQA-5	10.100.14.105								
XIRRUS\David.Levin	00:24:d7:bf:a5:48		10.100.25.29	■		■		■			■
David.Levin	e0:f8:47:21:7e:5a	MACBOOKPRO-77D7	10.100.25.47								

Figure 76. Station Noise Floor Values

You may choose to display **Unassociated Stations** as well with a checkbox at the bottom of the window.

By default, the noise floor is displayed numerically. (Figure 76) You may display the relative value using color if you select **Colorize Intensity**, with the highest noise indicated by the most intense color. If you select **Graph**, then the ambient noise is shown on a representation of the AP, either colorized or numerically based on your selection.(Figure 77) The stations are listed to the left of the AP—click on a station to show its values on the AP.

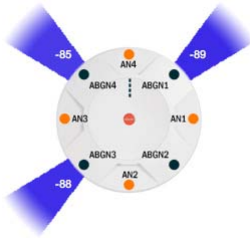



Figure 77. Station Noise Floor Values—Colorized Graphical View

In either graphical or tabular view, you may sort the rows based on any column that has an active column header, indicated when the mouse pointer changes to the hand icon . Click on the **Refresh** button to refresh the station list, or click in the **Auto Refresh** check box to instruct the AP to refresh this window automatically.

*See Also*

[Station Status Windows](#)

[RF Monitor Windows](#)



### Max by IAP

This status-only window shows the maximum number of client stations that have historically been associated to the AP. For each IAP, the list shows the IAP’s state and channel number, the current number of stations associated, and the highest number of stations that have been associated over various periods of time: hour, day, week, month, and year. In other words, the Max Station Count shows the “high water mark” over the selected period of time—the maximum count of stations for the selected period, rather than a cumulative count of all stations that have associated. This information aids in network administration and in planning for additional capacity.

The screenshot shows a web interface with a dark header bar containing 'Logged in as: admin' and a star icon. Below the header is a light grey bar with an 'Auto Refresh' checkbox (unchecked) and a 'Refresh' button. The main content is a table with the following data:

Radio	State	Channel	Current Stations	Max station count				
				Hour	Day	Week	Month	Year
lap1		1 manual	1	1	1	1	1	1
lap2		157+161 automatic	0	1	1	1	1	1

Figure 78. Max by IAP

You may click an IAP to go to the [IAP Settings](#) window. Click on the **Refresh** button to refresh the station list, or click **Auto Refresh** to instruct the AP to refresh this window automatically.

*See Also*

[IAPs](#)

[Station Status Windows](#)

## Station Assurance

Station assurance monitors the quality of the connections that users are experiencing on the wireless network. This window shows client stations that have had connectivity issues. You may enable or disable the station assurance feature and set thresholds for the problems that it checks, such as excessive packet retry or packet error rates, or stations that are unable to stay associated to the AP. Please see [“Station Assurance” on page 371](#) for more information about these settings. When the AP detects that a station has reached the threshold value for one or more of the issues checked, it adds the station to this page. In addition, an event is triggered, a trap is generated, and a Syslog message is logged.

For each station, this list shows the MAC address, its IP address, its host name, its device type, device class, and manufacturer. It also shows the values of the various statistics that were monitored for problems as described in [“Station Assurance” on page 371](#): associated time, authentication failures, packet error rate, packet retry rate, packet data rate, RSSI, signal to noise ratio (SNR), and distance.

Clear Inactive		Clear All												<input type="checkbox"/> Auto Refresh	Refresh
Time	MAC Address	IP Address	Hostname	Device Type	Device Class	Manufacturer	Assoc Time	Auth Fails	Error Rate	Retry Rate	Data Rate	RSSI (dB)	SNR (dB)	Distance (ft)	Driver Check
No stations with current connectivity issues.															

Figure 79. Station Assurance

You may click the **Clear Inactive** button to remove stations that are no longer connected to the AP from the list. Click the **Clear All** button to remove all entries and start fresh to add problem stations to the list as they are detected. Click on the **Refresh** button to refresh the station list, or click **Auto Refresh** to instruct the AP to refresh this window automatically.

*See Also*

IAPs

Station Status Windows

Station Assurance

## Statistics Windows

The following AP Statistics windows are available:

- **IAP Statistics Summary**—provides an overview of the statistical data associated with all IAPs. Expands to show links for displaying detailed statistics for individual IAPs.
- **Per-IAP Statistics**—provides detailed statistics for an individual IAP.
- **Network Statistics**—displays statistical data associated with each network (Ethernet) interface.
- **VLAN Statistics**—provides statistical data associated with your assigned VLANs.
- **WDS Statistics**—provides statistical data for all WDS client and host links.
- **IDS Statistics**—provides statistical data for intrusion detection.
- **Filter Statistics**—provides statistical data for all configured filters.
- **Station Statistics**—provides statistical data associated with each station.

### IAP Statistics Summary

This is a status only window that provides an overview of the statistical data associated with all IAPs. It also shows the channel used by each IAP. For detailed statistics for a specific IAP, see [“Per-IAP Statistics” on page 144](#). Click the **Unicast Stats Only** checkbox on the lower left to filter the results, or clear the checkbox to show statistics for all wireless traffic.

IAP	Channels	Receive Statistics by IAP				Transmit Statistics by IAP			
		Bytes	Packets	Errors	Retries	Bytes	Packets	Errors	Retries
iap1	1	270102889	1115539	697236	66645	266129991	635718	7	5689
iap2	157 161	306939499	1672137	785496	545054	279329571	267760	1	988

Figure 80. IAP Statistics Summary Page

You can **Refresh** the data (update the window with the latest information) or **Clear** the data (reset all content to zero and begin counting again) at any time by

clicking on the appropriate button. You can also click in the **Auto Refresh** check box to instruct the AP to refresh this window automatically.

*See Also*

[System Log Window](#)

[Global Settings](#)

[Global Settings .11an](#)

[Global Settings .11bgn](#)

[IAPs](#)

### Per-IAP Statistics

This is a status only window that provides detailed statistics for the selected IAP. Scroll the window down to see a breakout of the statistics by connection rate. For a summary of statistics for all IAPs, see [“IAP Statistics Summary” on page 143](#). Use the **Display Percentages** checkbox at the upper left to select the output format—check this option to express each statistic as a percentage of the total at the top of the column, or leave it blank to display raw numbers.

Receive Error statistics include:

- **Total Retries:** the count of packets that were sent more than once before being received correctly.
- **CRC error:** the count of packets that were corrupted on the air and were dropped. Some level of CRC errors are expected in wireless networks. Note that all IAPs operate in a mode where they are listening to everything all the time, which means they will see many CRC errors.
- **Fragment Errors:** the count of packets that were incomplete.
- **Encryption Errors:** the count of packets that had encryption problems.
- **Duplicates:** the count of packets that were received more than once. The duplicate packets are dropped.
- **Dropped Packets:** the count of packets that were dropped due to various receive errors, including being received when all receive queues were full. These packets are dropped after being received.
- **Overruns:** indicate the number of times that First-In-First-Out (FIFO) overflow errors occur.

Receive Statistics		Transmit Statistics	
Total Bytes	270574191	Total Bytes	266530030
Total Packets	1117803	Total Packets	636864
Unicasts	83069	Unicasts	57697
Multicasts	18695	Multicasts	0
Broadcasts	25421	Broadcasts	642
Mgmt Packets	71150	Mgmt Packets	18630
Beacons	990618	Beacons	578525
Fragments	0	Fragments	0
RTS Count	0	RTS Count	0
CTS Count	0	CTS Count	0

Receive Errors & Retries		Transmit Errors & Retries	
Total Errors	764712	Total Errors	5701
Total Retries	66794	Total Retries	5694
Dropped Packets	684811	Dropped	0
Unassociated	0	Unassociated	7
CRC	12937	ACK Failures	0
Fragment Errors	0	RTS Failures	0
Encryption Errors	0	RTS Retries	0
Duplicates	170	Single Retries	0
Overruns	0	Multiple Retries	5694

Receive Statistics by Rate				Transmit Statistics by Rate				
Rate	Bytes	Packets	Errors	Retries	Bytes	Packets	Errors	Retries
<b>802.11b CCK Rates</b>								
1	167106905	565032	0	7695	19420	112	0	0
2	66171309	487639	0	9714	0	0	0	0
<b>802.11ag OFDM Rates</b>								
6	6090	46	0	0	204219325	578525	0	0
9	2782	25	0	0	0	0	0	0
12	3136	28	0	0	0	0	0	0
18	913	4	0	0	0	0	0	0
24	1934	5	0	0	0	0	0	0
36	2031	13	0	0	0	0	0	0
48	2922	26	0	0	624	3	0	0
54	1698	9	0	0	0	0	0	0
<b>802.11n 20Mhz Channel, Normal Guard Interval, 1 Spatial Stream Rates</b>								
19.5	5175	21	0	0	0	0	0	0
26.0	6188	53	0	0	3129636	2070	0	0
39.0	16260	116	0	0	45358848	30614	0	0

Figure 81. Individual IAP Statistics Page

You can **Refresh** the data (update the window with the latest information) or **Clear** the data (reset all content to zero and begin counting again) at any time by clicking on the appropriate button. You can also click in the **Auto Refresh** check box to instruct the AP to refresh this window automatically.

*See Also*

[System Log Window](#)

[Global Settings](#)

[Global Settings .11an](#)

[Global Settings .11bgn](#)

[IAPs](#)

## Network Statistics

This is a status only window that allows you to review statistical data associated with each network (Ethernet) interface and its activity. You can **Refresh** the data (update the window with the latest information) or **Clear** the data (reset all content to zero and begin counting again) at any time by clicking on the appropriate button. You can also click in the **Auto Refresh** check box to instruct the AP to refresh this window automatically. If you are experiencing problems on the AP, you may also want to print this window for your records

Clear All		<input type="checkbox"/> Auto Refresh	Refresh
<b>Gigabit Ethernet 1 Statistics</b>		<b>up, link up, 1000, full duplex</b>	
Receive Bytes	4240252284	Transmit Bytes	79355739
Receive Packets	3181159	Transmit Packets	1174334
Receive Compressed	0	Transmit Compressed	(
Receive Multicast	1010219	Transmit Carrier Errors	(
Receive Dropped	0	Transmit Dropped	(
Receive FIFO Errors	0	Transmit FIFO Errors	(
Receive Frame Errors	0	Transmit Collisions	(
Receive Total Errors	0	Transmit Total Errors	(
<b>Gigabit Ethernet 2 Statistics</b>		<b>up, link down, 10, half duplex</b>	
Receive Bytes	0	Transmit Bytes	(
Receive Packets	0	Transmit Packets	(
Receive Compressed	0	Transmit Compressed	(
Receive Multicast	0	Transmit Carrier Errors	(
Receive Dropped	0	Transmit Dropped	(
Receive FIFO Errors	0	Transmit FIFO Errors	(
Receive Frame Errors	0	Transmit Collisions	(
Receive Total Errors	0	Transmit Total Errors	(

Figure 82. Network Statistics

*See Also*

[DHCP Server](#)  
[DNS Settings](#)  
[Network Interfaces](#)

### VLAN Statistics

This is a status only window that allows you to review statistical data associated with your assigned VLANs. You can refresh the information that is displayed on this page at any time by clicking on the **Refresh** button, or select the **Auto Refresh** option for this window to refresh automatically. The **Clear All** button at the lower left allows you to clear (zero out) all VLAN statistics.

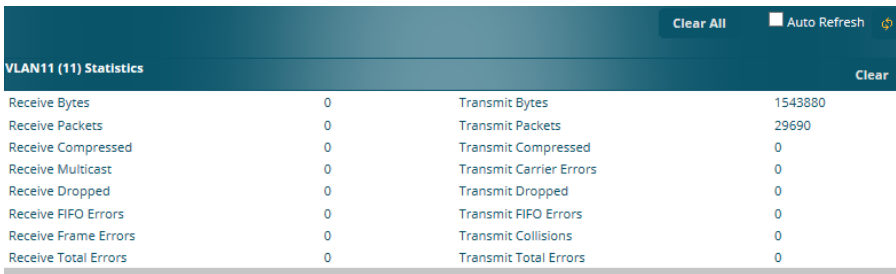

VLAN11 (11) Statistics				Clear
Receive Bytes	0	Transmit Bytes	1543880	
Receive Packets	0	Transmit Packets	29690	
Receive Compressed	0	Transmit Compressed	0	
Receive Multicast	0	Transmit Carrier Errors	0	
Receive Dropped	0	Transmit Dropped	0	
Receive FIFO Errors	0	Transmit FIFO Errors	0	
Receive Frame Errors	0	Transmit Collisions	0	
Receive Total Errors	0	Transmit Total Errors	0	

Figure 83. VLAN Statistics

*See Also*

[VLAN Management](#)  
[VLANs](#)

### WDS Statistics

The main WDS Statistics window provides statistical data for all WDS client and host links. To access data about a specific WDS client or host link, simply click on the desired link in the left frame to access the appropriate window. You may also choose to view a sum of the statistics for all client links, all host links, or all links (both client and host links).

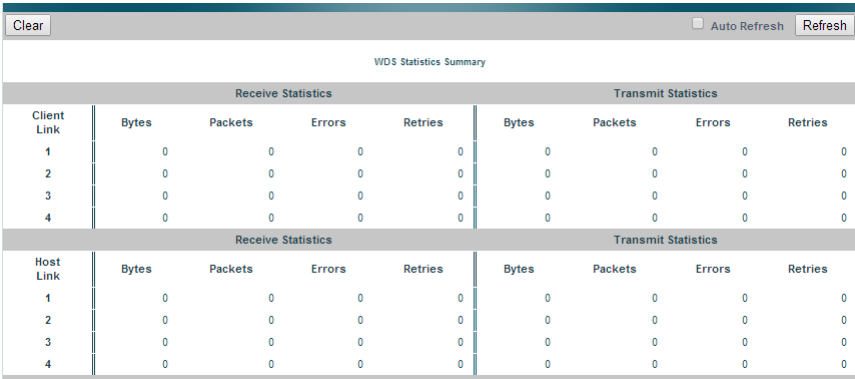

The screenshot shows a window titled "WDS Statistics Summary" with a "Clear" button on the left and "Auto Refresh" (unchecked) and "Refresh" buttons on the right. The window contains two tables. The first table, "Client Link", has columns for "Client Link", "Bytes", "Packets", "Errors", "Retries", "Bytes", "Packets", "Errors", and "Retries". The second table, "Host Link", has the same columns. All data values in both tables are 0.

WDS Statistics Summary								
Receive Statistics					Transmit Statistics			
Client Link	Bytes	Packets	Errors	Retries	Bytes	Packets	Errors	Retries
1	0	0	0	0	0	0	0	0
2	0	0	0	0	0	0	0	0
3	0	0	0	0	0	0	0	0
4	0	0	0	0	0	0	0	0

Receive Statistics					Transmit Statistics			
Host Link	Bytes	Packets	Errors	Retries	Bytes	Packets	Errors	Retries
1	0	0	0	0	0	0	0	0
2	0	0	0	0	0	0	0	0
3	0	0	0	0	0	0	0	0
4	0	0	0	0	0	0	0	0

Figure 84. WDS Statistics

*See Also*  
[SSID Management](#)  
[WDS](#)



### IDS Statistics

The Riverbed AP employs a number of IDS/IPS (Intrusion Detection System/Intrusion Prevention System) strategies to detect and prevent malicious attacks on the wireless network. This status-only window provides detailed intrusion detection statistics for the selected IAP.

You must have **Intrusion Detection Mode** enabled to collect IDS statistics. See [“Intrusion Detection” on page 378](#). Information about IDS events is discussed in the [“IDS Event Log Window” on page 162](#).

Last Updated: Fri May 09 2014 10:56:48 GMT-0700 (Pacific Daylight Time) Auto Refresh

IDS Statistics

Filter: IAP Equal To  Filter Reset

IAP	Packet/Event	Count						Average					
		1 min	5 min	10 min	20 min	30 min	60 min	1 min	5 min	10 min	20 min	30 min	60 min
lap1	Beacons	1059	5310	10647	21343	26059	57661	1059	1062	1064	1067	858	951
lap1	Probe Requests	5	79	189	334	557	1383	5	15	18	16	18	23
lap1	Authentication	0	0	0	0	3	9	0	0	0	0	0	0
lap1	Association	0	0	0	0	3	9	0	0	0	0	0	0
lap1	Disassociation	0	0	1	1	1	1	0	0	0	0	0	0
lap1	Deauthentication	0	0	0	0	2	2	0	0	0	0	0	0
lap1	EAP	0	0	0	0	2	6	0	0	0	0	0	0
lap1	Null Probe Responses	0	0	0	0	0	0	0	0	0	0	0	0
lap1	MIC Errors	0	0	0	0	0	0	0	0	0	0	0	0
lap1	Spoofed Beacons	0	0	0	0	0	0	0	0	0	0	0	0
lap1	Spoofed Disassociation	0	0	0	0	0	0	0	0	0	0	0	0
lap1	Spoofed Deauthentication	0	0	0	0	0	0	0	0	0	0	0	0
lap1	Sequence Number Anomaly	0	0	0	0	0	0	0	0	0	0	0	0
lap2	Beacons	563	2821	5645	11330	17003	19736	563	564	564	566	566	-
lap2	Probe Requests	7	36	91	164	263	328	7	7	9	8	8	-
lap2	Authentication	0	0	0	0	1	1	0	0	0	0	0	-
lap2	Association	0	0	0	0	1	1	0	0	0	0	0	-

Figure 85. IDS Statistics Page

Use the filter feature to show only information for a selected IAP or for selected event types. Select the type of **Filter**: **IAP** to select IAPs, or **Packet/Event** to select particular attack types. Select the type of string matching, for example, **Begins with** or **Contains**. Then enter the string to be matched and click the **Filter** button. For example, in [Figure 86](#), the filter **Packet/Event Contains assoc** finds events that include the string **assoc** in any position. If you have an AP with 12 IAPs, then **IAP**

**Contains 1** will show entries for **iap1**, **iap10**, **iap11**, and **iap12**. Click the **Reset** button to return to showing all entries.



IDS Statistics															
Filter IAP		Contains		1						Filter		Reset			
IAP	Packet/Event	Count						Average							
		1 min	5 min	10 min	20 min	30 min	60 min	1 min	5 min	10 min	20 min	30 min	60 min		
iap1	Spoofed Disassociation	0	0	0	0	0	0	0	0	0	0	0	0		
iap1	Spoofed Deauthentication	0	0	0	0	0	0	0	0	0	0	0	0		
iap1	Spoofed Beacons	0	0	0	0	0	0	0	0	0	0	0	0		
iap1	Sequence Number Anomaly	0	0	0	0	0	0	0	0	0	0	0	0		
iap1	Probe Requests	10	72	157	332	514	1355	10	14	15	16	17	22		

Figure 86. Filtered IDS Statistics

Many of the column headers may be clicked to sort the entries in ascending or descending order based on that column. You can **Refresh** the data (update the window with the latest information) at any time by clicking the **Refresh** button  on the upper right. You can also click in the **Auto Refresh** check box to instruct the AP to refresh this window automatically.

### See Also

[Intrusion Detection  
IDS Event Log Window](#)

### Filter Statistics

The Filter Statistics window provides statistical data for all configured filters. The name, state (enabled—on or off), and type (allow or deny) of each filter is shown. For enabled filters, this window shows the number of packets and bytes that met the filter criteria. Click on a column header to sort the rows based on that column. Click on a filter name to edit the filter settings.

<input type="checkbox"/> Detail		<input type="checkbox"/> Auto Refresh		Refresh	Clear All
Name	Type	State	Packets	Bytes	
<b>Global</b>					
Air-cleaner-Mcast.1	deny	on	4054013	5210334627	
Air-cleaner-Mcast.2	deny	on	65294	13005313	
Air-cleaner-Mcast.3	deny	on	0	0	
Air-cleaner-Nbios.1	deny	on	90348	7050384	
Air-cleaner-Nbios.2	deny	on	492	113328	
Air-cleaner-Nbios.3	deny	on	0	0	
<b>Multicast</b>					
Air-cleaner-Mcast.1	deny	on	0	0	
Air-cleaner-Mcast.2	deny	on	0	0	
Air-cleaner-Mcast.3	deny	on	0	0	

Figure 87. Filter Statistics

*See Also*

Filters

Application Control Windows

### Station Statistics

This status-only window provides an overview of statistical data for all stations. Stations are listed by MAC address, and Receive and Transmit statistics are summarized for each. For detailed statistics for a specific station, click the desired MAC address in the **Station** column or click the details button  in the station's **Link** column, and see “Per-Station Statistics” on page 153.



Last Updated: Fri May 02 2014 21:36:24 GMT-0700 (Pacific Daylight Time)										<input type="checkbox"/> Auto Refresh
Station Statistics Summary										
Station	Receive Statistics by Station				Transmit Statistics by Station				Link	
	Bytes	Packets	Errors	Retries	Bytes	Packets	Errors	Retries		
00:db:df:1e:4f:e7	172360238	2250021	37936	0	2884465060	2137402	0	0		

Figure 88. Station Statistics

Click on a column header to sort the rows based on that column. You can **Refresh** the data (update the window with the latest information) at any time by clicking the refresh button  . You can also click in the **Auto Refresh** check box to instruct the AP to refresh this window automatically.

*See Also*

[Per-Station Statistics](#)  
[Stations](#)

### Per-Station Statistics

This window provides detailed statistics for the selected station. This window is accessed from the [Station Statistics](#) window—click the MAC address of the desired entry in the **Station** column to display its Per-Station Statistics window.

Receive and Transmit statistics are listed by **Rate**—this is the data rate in Mbps. For a summary of statistics for all stations, see “[Station Statistics](#)” on page 151.

You can **Refresh** the data (update the window with the latest information) at any time by clicking on the appropriate button. You can also click in the **Auto Refresh** check box to instruct the AP to refresh this window automatically.

Station Statistics Summary for 00:db:df:1e:4f:e7								
Rate	Receive Statistics by Rate				Transmit Statistics by Rate			
	Bytes	Packets	Errors	Retries	Bytes	Packets	Errors	Retries
<b>ALL RATES</b>								
All	172386114	2250200	37936	0	2884562956	2137564	0	0
<b>802.11a/g OFDM Rates</b>								
6	4087	37	0	0	0	0	0	0
9	72	1	0	0	0	0	0	0
12	1296	18	0	0	0	0	0	0
18	1788	25	0	0	0	0	0	0
24	29015	111	0	0	0	0	0	0
36	12567	101	0	0	0	0	0	0
48	16467	125	0	0	11018266	8081	0	0
54	1626	14	0	0	0	0	0	0
<b>802.11n/ac 20Mhz Channel, Normal Guard Interval, 1 Spatial Stream Rates</b>								
26.0	0	0	0	0	13511645	12857	0	0
39.0	0	0	0	0	784064161	711442	0	0
52.0	912	8	0	0	0	0	0	0
58.5	980	9	0	0	226039547	150492	0	0
65.0	832	9	0	0	49963325	33300	0	0
<b>802.11n/ac 20Mhz Channel, Short Guard Interval, 1 Spatial Stream Rates</b>								
21.7	936	13	0	0	0	0	0	0

Figure 89. Individual Station Statistics Page

*See Also*  
[Station Statistics](#)

## Application Control Windows



*This feature is only available if the AP license includes **Application Control**. See “[About Licensing and Upgrades](#)” on page 412.*

The Application Control feature provides real-time visibility of application usage by users across the wireless network. Network usage has changed enormously in the last few years, with the increase in smart phone and tablet usage stressing networks. Increasing traffic from legitimate business needs such as cloud- and web-based applications, streaming media and VoIP must be handled with an adequate quality of experience.

Application Control is discussed in the following topics:

- **About Application Control**—an overview of this feature.
- **Application Control**—displays information about applications running on the wireless network.
- **Stations (Application Control)**—displays a list of stations. Click one to analyze application control information for only that station.

### About Application Control

The AP uses Deep Packet Inspection (DPI) to determine what applications are being used and by whom, and how much bandwidth they are consuming. These applications are rated by their degree of risk and productiveness. [Filters](#) can be used to implement per-application policies that keep network usage focused on productive uses:

- Usage of non-productive and risky applications like BitTorrent can be restricted using [Filters](#).
- Traffic for mission-critical applications like VoIP and WebEx may be given higher priority (QoS).
- Non- critical traffic from applications like YouTube may be given lower priority (QoS).
- Traffic flows for specific applications may be controlled by sending them into VLANs that are designated for that type of traffic.

Application Control can track application usage over time to monitor trends. Usage may be tracked by AP, VLAN, or station. Many hundreds of applications are recognized and grouped into a number of categories. The distributed architecture of Riverbed APs allows Application Control to scale naturally as you grow the network.

### *About Risk and Productivity*

Application Control ranks applications in terms of their levels of risk and productivity.

**Productivity** indicates how appropriate an application is for business purposes. The higher the rating number, the more business-oriented an application is.

- 1—Primarily recreational
- 2—Mostly recreational
- 3—Combination of business and recreational purposes
- 4—Mainly used for business
- 5—Primarily used for business

**Risk** indicates how likely an application is to pose a threat to the security of your network. The higher the rating number, the more risky an application is.

- 1—No threat
- 2—Minimal threat
- 3—Some risk - may be misused
- 4—High risk - may be malware or allow data leaks
- 5—Very high risk - threat circumvents firewalls or avoids detection

### *Keeping Application Control Current*

Applications are recognized using a signature file which may be updated using the [System Tools](#) page as new applications become popular (see “[Application Control Signature File Management](#)” on page 422).

### Application Control

This display-only window provides a snapshot of the application usage on your AP. In order to view the Application Control window, the AP must have a license that supports this feature, and you must have enabled the **Application Control** option on the **Filter Management** page (see “Filter Management” on page 399).

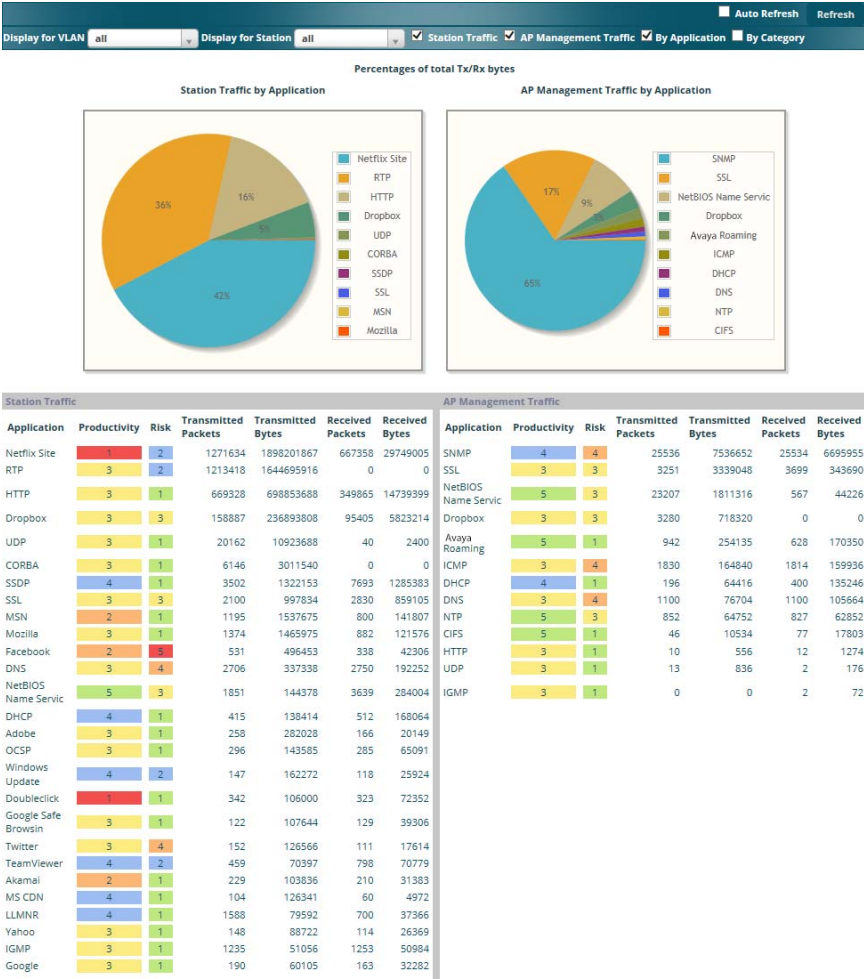

Figure 90. Application Control



The Application Control window has three sections:

- **Selection Criteria** allow you to choose the type of data to show, and to filter for a single VLAN or station.
- **Pie Charts** present a color coded at-a-glance view of the top ten applications being used by the network.
- **Traffic Tables** beneath the pie charts list the applications in use along with traffic statistics. Unique **Productivity** and **Risk** ratings let you easily assess the nature of applications in use, so that you can take action using [Filters](#).

### *Selection Criteria*

At the top of the window, the options in the gray ribbon allow you to customize the display with the following choices:

- **Display for VLAN:** Use the drop-down list if you wish to select just one VLAN to analyze, or leave the default value of **all** to see data from all VLANs.
- **Display for Station:** Use the drop-down list if you wish to select just one station to analyze (stations are listed by their MAC address), or leave the default value of **all** to see data from all stations. You may also use the Stations window to select a station to display. See [“Stations \(Application Control\)”](#) on page 160.
- **Station Traffic:** Check this box if you wish to analyze traffic from stations, listing the applications that they are using.
- **AP Management Traffic:** Check this box if you wish to analyze management traffic on this AP, including the load due to functions such as Riverbed Roaming. Tracking traffic into the AP on the management side can alert you to nefarious activity—and even to traffic on the wired network that would best be blocked before it hits the AP. You may display both station and AP management traffic, if you wish.
- **By Application:** Check this box if you wish to analyze and list traffic by what specific applications are in use, such as WebEx or BitTorrent.

- **By Category:** Check this box if you wish to analyze and list traffic by the types of applications in use, such as Games or Collaboration.
- **Auto Refresh** instructs the AP to periodically refresh this window automatically. Use the **Refresh** button to refresh the window right now.

### Pie Charts



Figure 91. Application Control (Pie Charts)

These charts provide a quick way to determine how your wireless bandwidth is being used. There are charts for **Station Traffic** and/or **AP Management Traffic**, depending on which checkboxes you selected. Similarly, there are charts for **By Application** and/or **By Category**, depending on your selections. The top ten applications or categories are listed, by percentage of bandwidth usage.

Traffic Tables

Station Traffic				AP Management Traffic									
Application	Productivity	Risk	Transmitted Packets	Transmitted Bytes	Received Packets	Received Bytes	Application	Productivity	Risk	Transmitted Packets	Transmitted Bytes	Received Packets	Received Bytes
Netflix Site	1	2	1271634	1898201867	667358	29749005	SNMP	4	4	25536	7536652	25534	66959
RTP	3	2	1213418	1644695916	0	0	SSL	3	3	3251	3339048	3699	3436
HTTP	3	1	669328	698853688	349865	14739399	NetBIOS Name Servic	5	3	23207	1811316	567	442
Dropbox	3	3	158887	236893808	95405	5823214	Dropbox	3	3	3280	718320	0	
UDP	3	1	20162	10923688	40	2400	Avaya Roaming	5	1	942	254135	628	1703
CORBA	3	1	6146	3011540	0	0	ICMP	3	4	1830	164840	1814	1599
SSDP	4	1	3502	1322153	7693	1285383	DHCP	4	1	196	64416	400	1352
SSL	3	3	2100	997834	2830	859105	DNS	3	4	1100	76704	1100	1056
MSN	2	1	1195	1537675	800	141807	NTP	5	3	852	64752	827	628
Mozilla	3	1	1374	1465975	882	121576	CIFS	5	1	46	10534	77	178
Facebook	2	5	531	496453	338	42306	HTTP	3	1	10	556	12	12
DNS	3	4	2706	337338	2750	192252	UDP	3	1	13	836	2	1
NetBIOS Name Servic	5	3	1851	144378	3639	284004	IGMP	3	1	0	0	2	
DHCP	4	1	415	138414	512	168064							
Adobe	3	1	258	282028	166	20149							
QOSP	3	1	296	143585	285	65091							
Windows Update	4	2	147	162272	118	25924							
DoubleClick	1	1	342	106000	323	72352							
Google Safe Browsin	3	1	122	107644	129	39306							
Twitter	3	4	152	126566	111	17614							
TeamViewer	4	2	459	70397	798	70779							

Figure 92. Application Control (Station Traffic)

These tables provide detailed information about how your wireless bandwidth is being used. There are tables for **Station Traffic** and/or **AP Management Traffic**, depending on which checkboxes you selected. Similarly, there are tables for **By Application** and/or **By Category**, depending on your selections.

In addition to showing traffic statistics, there are two unique and highly useful columns. **Risk** estimates the likelihood of an application causing problems for your business, such as a file-sharing utility introducing viruses or exposing you to legal problems. Risk is rated from 1 (low risk: for example, Google) to 5 (high risk: for example, BitTorrent). Risky applications (rated at 4 or 5) are flagged for your attention by highlighting the entry in pale red. **Productivity** estimates the value of an activity to your business, from 1 (unproductive: for example, Y8 gaming) to 5 (productive: for example, WebEx).

You may click the heading of any column to sort based on that column. Click again to sort in the reverse order. For instance, sort on **Risk** to find problem applications, or sort on **Productivity** to find applications that should be given increased or decreased handling priority.

When you find risky or unproductive applications consuming bandwidth on the network, you can easily create [Filters](#) to control them. See “[Filters](#)” on page 400. You may use filters to:

- Block problematic traffic, such as BitTorrent or Y8.
- Prioritize mission critical traffic—by increasing the QoS assigned to the traffic. See “[Understanding QoS Priority on the Wireless AP](#)” on page 277.
- Lower the priority of less productive traffic—use filters to decrease the QoS assigned to traffic for applications like YouTube and Facebook.

### Stations (Application Control)

This status-only window shows client stations currently visible to the AP. The MAC address in the first column is a link. Click on a selected station, and the [Application Control](#) window opens with the **Display for Station** field set to that station, to perform a detailed analysis of its application usage.

Total Stations: 1 <input type="checkbox"/> Identification <input type="checkbox"/> Security <input type="checkbox"/> Connection Info <input type="checkbox"/> Auto Refresh <input type="button" value="Refresh"/>											
MAC Address	IP Address	SSID	Group	VLAN	QOS	Radio	TX Rate	RX Rate	RSSI	Last Alarm	Time D:H:M
<a href="#">00:db:df:1e:4fe7</a>	192.168.1.78	xyzcorp		2	iap1	39.0Mbps	144.4Mbps	-51	none	0:00:49	

Figure 93. Stations (Application Control)

The rest of the fields and display options on this window (including the **Identification**, **Security**, and **Connection Info** checkboxes) are as described in “[Stations](#)” on page 131.



## System Log Window

This is a status only window that allows you to review the system log, where system alerts and messages are displayed. Although there are no configuration options available in this window, you do have the usual choice of deciding how the event messages are sorted by clicking in the column header for the desired field (Time Stamp, Priority, or Message).

- **Time Stamp**—sorts the list based on the time the event occurred.
- **Priority**—sorts the list based on the priority assigned to the message.
- **Message**—sorts the list based on the message category

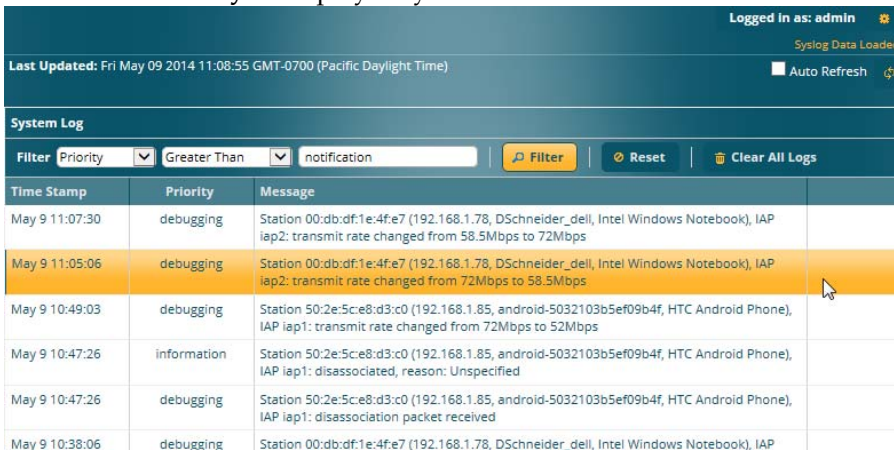
The displayed messages may be filtered by using the **Filter Priority** option, which allows control of the minimum priority level displayed. For example, you may choose (under **Services >System Log**) to log messages at or above Debug level but use **Filter Priority** to display only those at Information level and above.



Logged in as: admin   
Syslog Data Loaded  
Last Updated: Fri May 09 2014 11:08:55 GMT-0700 (Pacific Daylight Time)  Auto Refresh 

System Log

Filter Priority

Time Stamp	Priority	Message
May 9 11:07:30	debugging	Station 00:db:df:1e:4f:e7 (192.168.1.78, D5schneider_dell, Intel Windows Notebook), IAP iap2: transmit rate changed from 58.5Mbps to 72Mbps
May 9 11:05:06	debugging	Station 00:db:df:1e:4f:e7 (192.168.1.78, D5schneider_dell, Intel Windows Notebook), IAP iap2: transmit rate changed from 72Mbps to 58.5Mbps
May 9 10:49:03	debugging	Station 50:2e:5ce8:d3:c0 (192.168.1.85, android-5032103b5ef09b4f, HTC Android Phone), IAP iap1: transmit rate changed from 72Mbps to 52Mbps
May 9 10:47:26	information	Station 50:2e:5ce8:d3:c0 (192.168.1.85, android-5032103b5ef09b4f, HTC Android Phone), IAP iap1: disassociated, reason: Unspecified
May 9 10:47:26	debugging	Station 50:2e:5ce8:d3:c0 (192.168.1.85, android-5032103b5ef09b4f, HTC Android Phone), IAP iap1: disassociation packet received
May 9 10:38:06	debugging	Station 00:db:df:1e:4f:e7 (192.168.1.78, D5schneider_dell, Intel Windows Notebook), IAP

Figure 94. System Log (Alert Level Highlighted)

Use the **Highlight Priority** field if you wish to highlight messages at the selected priority level. Click on the **Refresh** button to refresh the message list, or click on the **Clear All** button at the upper left to delete all messages. You can also click in the **Auto Refresh** check box to instruct the AP to refresh this window automatically.

## IDS Event Log Window

This status only window displays the Intrusion Detection System (IDS) Event log, listing any detected attacks on your network. For descriptions of the types of attacks detected, as well as the settings to fine-tune IDS on the AP, please see “[Intrusion Detection](#)” on page 378.

The displayed messages may be filtered by using the **Filter Event** setting, which allows you to select just one type of intrusion to display. For example, you may choose to display only beacon flood attacks.

Time Stamp	IAP	Channel	Event	SSID	MAC Address	Period	Current	Average	Maximum
May-09 10:21:56	iap1	1	AP impersonation			60	3	0	
May-09 10:20:56	iap1	1	AP impersonation			60	2	0	
May-09 10:19:56	iap1	1	AP impersonation			60	7	0	
May-09 10:18:55	iap1	1	AP impersonation			60	1	0	
May-09 10:17:55	iap1	1	AP impersonation			60	1	0	
May-09 10:16:55	iap1	1	AP impersonation			60	5	0	
May-09 10:15:35	iap1	1	AP impersonation			60	2	0	
May-09 10:14:35	iap1	1	AP impersonation			60	2	0	
May-09 10:13:25	iap1	1	AP impersonation			60	3	0	
May-09 10:11:15	iap1	1	AP impersonation			60	2	0	

Figure 95. IDS Event Log

Use the **Highlight Event** field if you wish to highlight all events of one particular type in the list. Click on a column header to sort the rows based on that column. Click on the **Refresh** button to refresh the message list, or click the **Auto Refresh** check box to instruct the AP to refresh this window automatically.

Although there are no configuration options available in this window, you do have the usual choice of deciding how the event messages are sorted by clicking in the column header for the desired field.

- **Time Stamp**—the time that the event occurred.
- **IAP**—the affected radio.
- **Channel**—the affected channel.
- **Event**—the type of attack, as described in [Intrusion Detection](#).
- **SSID**—the SSID that was attacked.
- **MAC Address**—the MAC address of the attacker.

- **Period**—the length of the window used to determine whether the count of this type of event exceeded the threshold.
- **Current**—the count of this type of event for the current period.
- **Average**—the average count per period of this type of event.
- **Maximum**—the maximum count per period of this type of event.





# Configuring the Wireless AP

The following topics include procedures for configuring the AP using the product's embedded Windows Management Interface (WMI). Procedures have been organized into functional areas that reflect the [flow and content](#) of the WMI. The following WMI windows allow you to establish configuration parameters for your AP, and include:

- [“Express Setup” on page 167](#)
- [“Network” on page 173](#)
- [“Services” on page 189](#)
- [“VLANs” on page 217](#)
- [“Tunnels” on page 225](#)
- [“Security” on page 230](#)
- [“SSIDs” on page 274](#)
- [“Groups” on page 310](#)
- [“IAPs” on page 317](#)
- [“WDS” on page 391](#)
- [“Filters” on page 398](#)
- [“Mobile” on page 407](#)

After making changes to the configuration settings of an AP you must click the **Save** button  at the top of the configuration window, otherwise the changes you make will not be applied the next time the AP is rebooted.



*Some pages or individual settings are only available if the AP's license includes appropriate features. If a setting is unavailable (grayed out), then your license or your AP model does not support the feature. See [“About Licensing and Upgrades” on page 412](#).*



*If you have added modular IAPs to your AP, note that its model number will be automatically adjusted to reflect the count and types of IAPs currently installed. See [Upgrading with 802.11ac radio modules](#).*

This chapter only covers using the configuration windows on the AP. To view status or use system tools on the AP, please see:

- [“Viewing Status on the Wireless AP” on page 99](#)
- [“Using Tools on the Wireless AP” on page 411](#)

## Express Setup

Initial AP configuration via XMS sets items such as SSIDs and security, as described in “Zero-Touch Provisioning and Ongoing Management” on page 79. This page allows you to see many of these values, or change them locally.

<b>License</b>	
License Key:	<input type="text" value="1P34Q-B75X6-9UR11-AI"/> <input type="button" value="Apply"/>
<b>Contact Information</b>	
Location:	<input type="text" value="Anywhere, USA"/>
Contact Name:	<input type="text" value="J Smith"/>
Contact Email:	<input type="text" value="jsmith@xyzcorp.com"/>
Contact Phone:	<input type="text" value="212 555-1212"/>
<b>Network Settings</b>	
Host Name:	<input type="text" value="factoryap"/>
Address Type:	<input checked="" type="radio"/> DHCP <input type="radio"/> Static
IP Settings:	Address: <input type="text" value="192.168.1.84"/> Subnet Mask: <input type="text" value="255.255.255.0"/> Default Gateway: <input type="text" value="192.168.1.254"/> <input type="button" value="Apply"/>
<b>SSID Settings</b>	
SSID Name (Replaces SSID "xirrus"):	<input type="text"/>
Wireless Security:	<input type="text" value="Open"/> <input type="button" value="Apply SSID Settings"/>
Current SSIDs	guest honeypot xyzcorp
<b>Admin Settings</b>	
New Admin User (Replaces user "admin"):	<input type="text"/>
New Admin Privilege Level:	<input type="text" value="1 : read-write"/>
New Admin Password:	<input type="text"/>
Confirm Admin Password:	<input type="text"/>
	<input type="button" value="Apply Admin Settings"/>
<b>Time and Date Settings</b>	
Time Zone:	<input type="text" value="(GMT - 08:00) Pacific Time (US &amp; Canada); Tijuana"/>
<b>Quick Configuration</b>	
Apply Quick Configuration Template:	<input type="text" value="Select a Te..."/> <input type="button" value="Apply"/>
<b>IAP Settings</b>	
Enable/Configure All IAPs:	<input type="button" value="Execute"/>

Figure 96. WMI: Express Setup

When finished, click the **Save** button  if you wish to make your changes permanent.

### *Procedure for Performing an Express Setup*

1. **License Key:** An unlicensed AP will automatically contact Riverbed to obtain its license, if it has Internet connectivity. If you need to enter a license manually, enter it here. The factory installed license key is listed here. See [“Licensing” on page 84](#).
2. Configure the **Contact Information** settings.
  - a. **Location:** Enter a brief but meaningful description that accurately defines the physical location of the AP. In an environment where multiple units are installed, clear definitions for their locations are important if you want to identify a specific unit.
  - b. **Contact Name:** Enter the name and contact information of the person who is responsible for administering the AP at the designated location.
  - c. **Contact Email:** Enter the email address of the admin contact you entered in Step 3.
  - d. **Contact Phone:** Enter the telephone number of the admin contact you entered in Step 3.
3. Configure the **Network** settings. Please see [“Interfaces” on page 174](#) for more information.
  - a. **Host Name:** Specify a unique [host name](#) for this AP. The host name is used to identify the AP on the network. Use a name that will be meaningful within your network environment, up to 64 alphanumeric characters. The default is the AP’s serial number.
  - b. **Address Type:** Choose **DHCP** to instruct the AP to use **DHCP** to assign IP addresses to the AP’s Ethernet interfaces, or choose **Static** if you intend to enter IP addresses manually. If you choose the Static IP option, you must enter the following **IP Settings**:

- c. **IP Settings:** If you choose the **Static** IP addressing option, enter the following:
  - **Address:** Enter a valid IP address for this AP. To use a remote connection (Web, [SNMP](#), or [SSH](#)), a valid IP address must be used.
  - **Subnet Mask:** Enter a valid IP address for the [subnet mask](#) (the default is 255.255.255.0). The subnet mask defines the number of IP addresses that are available on the routed subnet where the AP is located.
  - **Default Gateway:** Enter a valid IP address for the [default gateway](#). This is the IP address of the router that the AP uses to forward data to other networks.
  - Click the **Apply** button for this interface when done making IP changes.



*For improved security, you should also take the additional steps described in “Securing Low Level Access to the AP” on page 85.*

4. **SSID Settings:** This section specifies the wireless network name and security settings.
  - a. **SSID Name** is a unique name that identifies a wireless network. The default SSID is **xirrus**. Entering a value in this field will replace the this default SSID with the new name.

For additional information about SSIDs, go to the [Multiple SSIDs](#) section of “[Frequently Asked Questions](#)” on page 532.

- b. **Wireless Security:** Select the desired wireless security scheme (Open, [WEP](#) or [WPA](#)). Make your selection from the choices available in the pull-down list.
    - **Open**—This option offers no data encryption and is not recommended, though you might choose this option if clients are required to use a VPN connection through a secure SSH utility, like PuTTY.

- **WEP** (Wired Equivalent Privacy)—An optional IEEE 802.11 function that offers frame transmission privacy similar to a wired network. WEP generates secret shared encryption keys that both source and destination stations can use to alter frame bits to avoid disclosure to eavesdroppers.
- **WPA** (Wi-Fi Protected Access)—A Wi-Fi Alliance standard that contains a subset of the IEEE 802.11i standard, using TKIP or AES as an encryption method and 802.1x for authentication. WPA is the stronger of the two wireless security schemes.
- **WPA2** (Wi-Fi Protected Access 2)—WPA2 is the follow-on security method to WPA for wireless networks and provides stronger data protection and network access control. It offers Enterprise and consumer Wi-Fi users with a high level of assurance that only authorized users can access their wireless networks. Like WPA, WPA2 is designed to secure all versions of 802.11 devices, including 802.11a, 802.11b, 802.11g, and 802.11n, multi-band and multi-mode.
- **WPA-Both** (WPA and WPA2)—This option makes use of both WPA and WPA2.

For more information about security, including a full review of all security options and settings, go to [“Understanding Security” on page 231](#).

- WEP Encryption Key/WPA Passphrase:** Depending on the wireless security scheme you selected, enter a unique WEP key or WPA passphrase. This field and the one below only appear if you select a **Wireless Security** option other than **Open**.
- Confirm Encryption Key/Passphrase:** If you entered a WEP key or WPA passphrase, confirm it here.
- Click **Apply SSID Settings** when done.
- Current SSIDs:** This lists all of the currently defined SSIDs for you (regardless of whether they are enabled or not).

5. **Admin Settings:** This section allows you to change the default admin username, password, and privileges for the AP. You may change the password and leave the user name as is, but we suggest that you change both to improve AP security.
  - a. **New Admin User (Replaces user “admin”):** Enter the name of a new administrator user account. Be sure to record the new account name and password, because the default **admin** user will be deleted! Note that the AP also offers the option of authenticating administrators using a RADIUS server (see [“Admin Management” on page 236](#)).
  - b. **New Admin Privilege Level:** By default, the new administrator will have read/write privileges on the AP (i.e., the new user will be able to change the configuration of the AP). If you wish the new account to have different privileges, select the desired level from the drop-down list. For more information about user privileges, please see [“Admin Privileges” on page 238](#). Take care to make sure to leave yourself enough read/write privileges on at least one account to be able to administer the AP.
  - c. **New Admin Password:** Enter a new administration password for managing this AP. If you forget this password, you must reset the AP to its factory defaults so that the password is reset to **admin** (its default setting).
  - d. **Confirm Admin Password:** If you have entered a new administration password, confirm the new password here.
  - e. Click **Apply Admin Settings** when done.
6. **Time and Date Settings:** System time is synchronized using NTP (Network Time Protocol) by default. Use the drop-down list to select the **Time Zone**.
7. **Quick Configuration:** This offers predefined configuration options such as **Classroom** and **High-Density** that capture best practices from years of field experience. If one of the options in the drop-down list is appropriate

to your deployment, select it and click **Apply**. For example, the **High-Density** option uses best practices to configure the AP for high density settings such as lecture halls, convention centers, stadiums, etc.

8. **IAP Settings:**

Figure 97. LEDs are Switched On

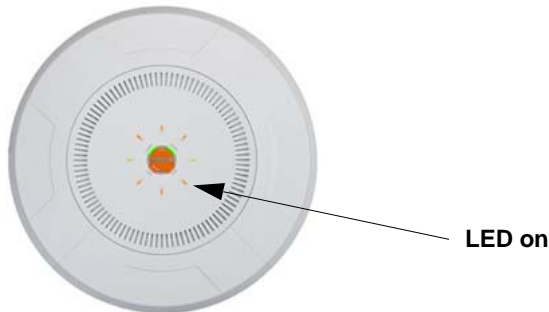

**Enable/Configure All IAPs:** Click on the **Execute** button to enable and auto configure all IAPs (a message displays the countdown time—in seconds—to complete the auto-configuration task). When enabled, the IAP's LED is switched on.

9. Click the **Save** button  at the upper right to make your changes permanent, i.e., these settings will still be in effect after a reboot.



## Network

This is a status-only window that provides a snapshot of the configuration settings currently established for the Ethernet interfaces. [DNS Settings](#) and other settings are summarized as well. You must go to the appropriate configuration window to make changes to any of the settings displayed here (configuration changes cannot be made from this window). You can click on any item in the **Interface** column to “jump” to the associated configuration window.





Logged in as: admin 												
Ethernet Information Loaded 												
Ethernet Settings Summary 												
Interface	State	Management	LED	Auto Neg	Link	Duplex	Speed (Mbps)	MTU Size	DHCP	IP Address	Subnet Mask	Gateway
<a href="#">gig1</a>	enabl...	enabled	disabled	on	up	full	1000	1500	enabled	192.16...	255.25...	192.168.1...
<a href="#">gig2</a>	enabl...	enabled	disabled	on	down	full	10	1500	enabled	192.16...	255.25...	192.168.1...
Bond Settings Summary 												
Interface	Bond		Mode		Ports		Active VLANs		Mirror			
<a href="#">gig1</a>	bond1		link-backup		gig1 gig2		all		off			
<a href="#">gig2</a>	bond1		link-backup		gig1 gig2		all		off			
DNS Settings Summary												
Hostname		Domain		DNS Server 1		DNS Server 2		DNS Server 3				
factoryap		gateway.2wire.net		192.168.1.254								

Figure 98. Network Interfaces

WMI windows that allow you to change or view configuration settings associated with the network interfaces include:

- “Interfaces” on page 174
- “Bonds and Bridging” on page 177
- “DNS Settings” on page 184
- “Cisco Discovery Protocol (CDP) Settings” on page 185
- “LLDP Settings” on page 186

### See Also

[DNS Settings](#)  
[Interfaces](#)

Network Status Windows  
Spanning Tree Status  
Network Statistics

## Interfaces

XR-500, XR-1000, and some XR-2000 Series APs have one Gigabit Ethernet interface, while XR- 600, XR-4000 and some XR-2000 Series APs have two, and XR-6000 Series models have four. This window allows you to establish configuration settings for these interfaces.

Logged In as: admin

### Gigabit Ethernet 1 Settings

Enable Interface:  Yes  No  
 LED Indicator:  Enabled  Disabled  
 Allow Management On Interface:  Yes  No  
 Auto Negotiate:  Yes  No  
 Duplex:  Full  Half  
 Maximum Transmission Unit (MTU):   
 Speed:   
 Configuration Server Protocol:  DHCP  Static  
 Address:  Subnet Mask:  Default Gateway:   
 IP Settings:

### Gigabit Ethernet 2 Settings

Enable Interface:  Yes  No  
 LED Indicator:  Enabled  Disabled  
 Allow Management On Interface:  Yes  No  
 Auto Negotiate:  Yes  No  
 Duplex:  Full  Half  
 Maximum Transmission Unit (MTU):   
 Speed:   
 Configuration Server Protocol:  DHCP  Static  
 Address:  Subnet Mask:  Default Gateway:   
 IP Settings:

Figure 99. Network Settings

When finished making changes, click the **Save** button  if you wish to make your changes permanent. When the status of a port changes, a Syslog entry is created describing the change.

### Network Interface Ports

For the location of network interface ports on an AP, see the illustrations in “User Interfaces” on page 80.

#### *Procedure for Configuring the Network Interfaces*

Configure the **Gigabit** network interfaces. The fields for each of these interfaces are the same, and include:

1. **Enable Interface:** Choose **Yes** to enable this network interface, or choose **No** to disable the interface.
2. **LED Indicator:** Choose **Enabled** to allow the LED for this interface to blink with traffic on the port, or choose **Disabled** to turn the LED off. The LED will still light during the boot sequence, then turn off. This option is only available for the Gigabit interfaces.
3. **Allow Management on Interface:** Choose **Yes** to allow management of this AP via the selected network interface, or choose **No** to deny all management privileges for this interface.



*For improved security, you should also take the additional steps described in “Securing Low Level Access to the AP” on page 85.*

4. **Auto Negotiate:** This feature allows the AP to negotiate the best transmission rates automatically. Choose **Yes** to enable this feature, or choose **No** to disable this feature—the default is enabled. If you disable the Auto Negotiate feature, you must define the Duplex and Speed options manually (otherwise these options are not available). Both sides of the link **must** have the same values for the following settings, or the connection will have errors.
  - a. **Duplex:** Full-duplex mode transmits data in two directions simultaneously (for example, a telephone is a full-duplex device because both parties can talk and be heard at the same time). Half-duplex allows data transmission in one direction at a time only (for example, a walkie-talkie is a half-duplex device). If the Auto-

Negotiate feature is disabled, you can manually choose **Half** or **Full** duplex for your data transmission preference.

- b. MTU:** The Maximum Transmission Unit size. This is the largest packet size (in bytes) that the interface can pass along.
  - c. Speed:** If the Auto-Negotiate feature is disabled, you must manually choose the data transmission speed from the pull-down list. For the Gigabit interfaces the options are **10 Megabit** or **100 Megabit**. (Note that 1000 Megabit speed can only be set by Auto-Negotiation. For APs that support 2.5 Gigabits, that speed can only be set by Auto-Negotiation.)
- 5. Configuration Server Protocol / IP Settings:** Choose **DHCP** to instruct the AP to use **DHCP** when assigning IP addresses to the AP, or choose **Static IP** if you intend to enter IP addresses manually. If you select the Static IP option you must specify the IP address, IP subnet mask and default gateway.
- a. Address:** If you selected the Static IP option, enter a valid IP address for the AP. To use any of the remote connections (Web, **SNMP**, or SSH), a valid IP address must be established.
  - b. Subnet Mask:** If you selected the Static IP option, enter a valid IP address for the **subnet mask** (the default for Class C is 255.255.255.0). The subnet mask defines the number of IP addresses that are available on the routed subnet where the AP is located.
  - c. Default Gateway:** If you selected the Static IP option, enter a valid IP address for the **default gateway**. This is the IP address of the router that the AP uses to send data to other networks. (You don't need to enter the gateway if it is on the same subnet as the AP.)
  - d.** Click the **Apply** button for this interface when done making IP changes.
- 6.** When done configuring all interfaces as desired, click the **Save** button  if you wish to make your changes permanent.

*See Also*

- [Bonds and Bridging](#)
- [DNS Settings](#)
- [Network](#)
- [Network Statistics](#)
- [Spanning Tree Status](#)

### Bonds and Bridging

On models with more than one Gigabit port these ports may be bonded, i.e. configured to work together in sets. For example, one port may provide active backup or load balancing for another, or other options as described in this section. XR-6000 Series APs have four Gigabit ports, and you may specify which ports are bonded to work together as a pair. You may also select more than two ports to work together in one group.

A special option lets you configure bridging between the Gigabit ports on an AP that has two of these ports.

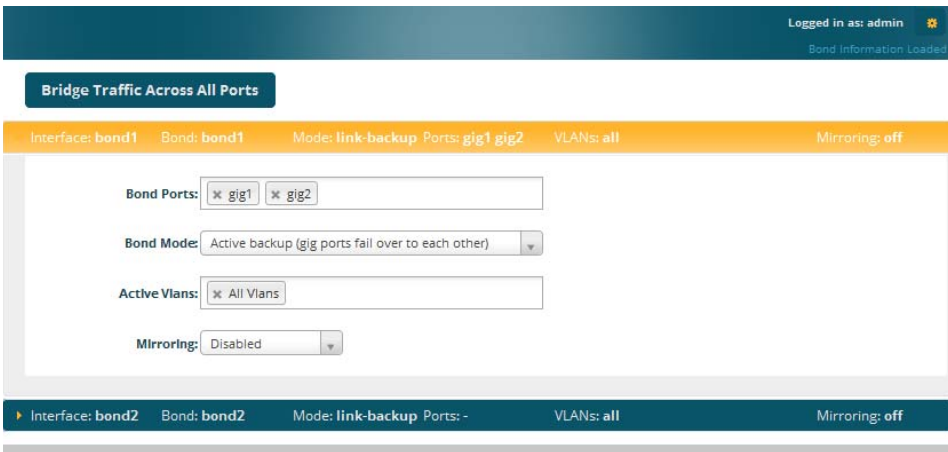

Figure 100. Network Bonds and Bridging

You may use the mirror option to have all the traffic that is ingressing and egressing one bond be transmitted by the bond you are configuring. For example, if you configure Bond2 to mirror Bond1, then all traffic going in and out of

Bond1's Gigabit ports will be transmitted out of Bond2's Gigabit ports. This way of duplicating one bond's traffic to another bond is very useful for troubleshooting with a network analyzer.



*If a set of Gigabit ports have been bonded, the IP address, IP mask, IP gateway, IP DHCP, and Management settings are shared between bonded ports. Any changes you make to these settings on one member will be reflected in the settings of the other members. Other settings may be configured individually.*

### ***Procedure for Configuring Network Bonds***

Configure the bonding behavior of the **Gigabit** network interfaces. The fields for each of these bonds are the same, and include:

1. **Bridge Traffic Across All Ports:** Click this for Layer 2 bridging between *all* Gigabit ports. (Figure 101)

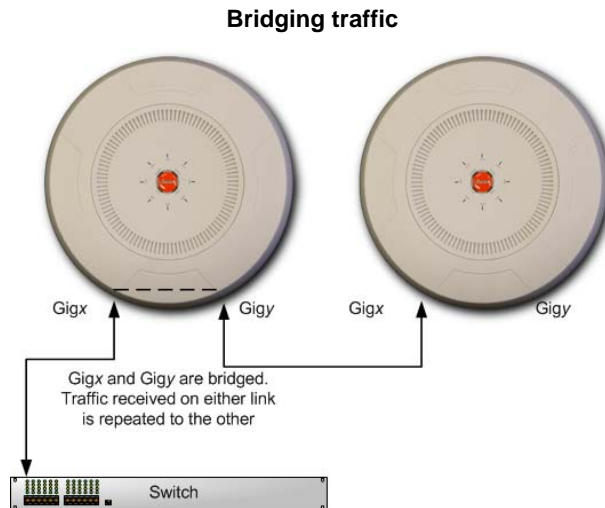

Figure 101. Bridging Traffic

Traffic received on Gig $x$  is transmitted by Gig $y$ ; similarly, traffic received on Gig $y$  is transmitted by Gig $x$ . The AP acts as a wired bridge—this allows APs to be chained and still maintain wired connectivity.



*Each AP in a chain must have power supplied to its PoE port from a compatible power injector or powered switch port. An AP does not supply power to another AP.*

When bridging is enabled, it configures the following bond settings for each bond. Do not make any manual changes to these settings afterwards if you wish to continue bridging.

- **Bond Mode** is set to **Active Backup** (the default value).
- Each port is in its own bond, by itself.
- **Bond Mirror** is **Off**.
- You will typically need to enable use of Spanning Tree manually, to prevent network loops.
- **Active VLANs** is set to **All**.

A bridge between ports **Gig1** and **Gig2** sets **Bond1** to contain only **Gig1**. **Bond2** contains only **Gig2**.

If you are bridging a chain of more than two APs, the endpoint AP is not actually bridging. It can be left with the default settings—**Bond1** is set to **Active Backup**, and will contain **Gig1** and **Gig2**.

Skip to [Step 7 on page 183](#).

2. If you are not enabling bridging, configure the bonding behavior of the **Gigabit** network interfaces as described in the following steps. The fields for each of these bonds are the same.
3. **Bond Mode**: Select the desired behavior for a set of bonded Gigabit Ethernet ports from the following options.

The modes below describe the relationship between a set of Gigabit ports—for example, load balancing or active backup. Use the **Bond Ports** field to select the ports that are bonded (set in [Step 4](#)). Two or more ports

may be bonded. You may also include just one single port in a bond—this is useful for mirroring one Gigabit port to another port ([Step c on page 182](#)). In APs that have four Gigabit ports, you have the option of bonding three or four ports together. In this discussion, we call two ports that are bonded **Gigx** and **Gigy**.

- a. **Active Backup (gig ports fail over to each other)**—This mode provides fault tolerance and is the default mode. Gigx acts as the primary link. Gigy is the backup link and is passive. Gigy assumes the IP properties of Gigx. If Gigx fails, the AP automatically fails over to Gigy. When a failover occurs in this mode, Gigy issues gratuitous ARPs to allow it to substitute for Gigx at Layer 3 as well as Layer 2. See [Figure 102 \(a\)](#). You may include more than two ports in the bond with Active Backup to provide additional fault tolerance. For example, if you have three Gigabit ports configured in a bond, if the first two ports in the bond were to go down, the AP would fail over traffic to the third Gigabit port.

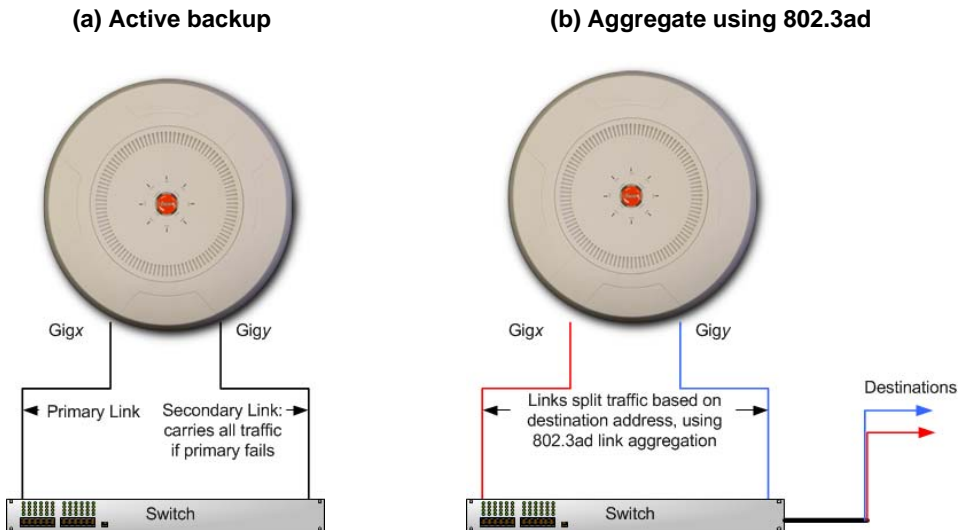

Figure 102. Port Modes (a, b)



- b. Aggregate Traffic from gig ports using 802.3ad**—The AP sends network traffic across all member Gigabit ports to increase link speed to the network. These ports act as a single logical interface, using a load balancing algorithm to balance traffic across the ports. For non-IP traffic (such as ARP), the last byte of the destination MAC address is used to do the calculation. If the packet is a fragment or not TCP or UDP, the source and destination IP addresses are used to do the calculation. If the packet is TCP or UDP over IP then the source IP address, destination IP address, source port number and destination port number are all used to do the calculation. The network switch must also support 802.3ad. If a port fails, the connection degrades gracefully—the other port still transmits. See [Figure 102 \(b\)](#).
- c. Transmit Traffic on all gig ports**—Transmits incoming traffic on all Gigabit ports. Any traffic received on Gigabit ports is sent to the onboard processor. This mode provides fault tolerance. See [Figure 103 \(c\)](#).

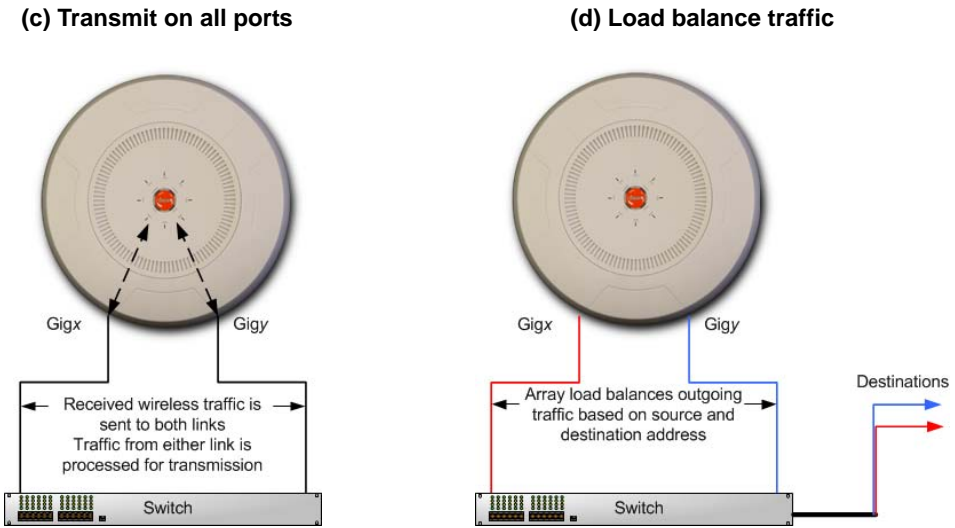

Figure 103. Port Modes (c, d)

- d. **Load balance traffic between gig ports**—This option provides trunking, similar to option (b)—**Aggregate Traffic from gig1 & gig2 using 802.3ad**, but it does not use 802.3ad and it uses a different load balancing algorithm to determine the outgoing Gigabit port. The outgoing port used is based on an exclusive OR of the source and destination MAC address. Like option (b), this mode also provides load balancing and fault tolerance. See [Figure 103 \(d\)](#).
4. **Bond Ports:** Select the ports to be members of this bond for the behavior specified by **Bond Mode**. By default, Bond1 contains Gig1 and Gig2. You may also set up a bond with a single port, for example, if you wish to mirror one Gigabit port to another. In APs that have four Gigabit ports, you also have the option of bonding three or four ports together.

When you check off a port to be a member of a bond, that port is automatically removed from any other bonds that contain it.

5. **Active VLANs:** **Active VLANs** shows the VLANs that you have selected to be passed through this port. Create and manage the list of VLANs that are allowed to be passed through this port. Traffic will be dropped for VLANs that are not in this list. The default setting is to pass All VLANs.
- a. To add a VLAN to the list of allowed VLANs, click this field and select the desired VLAN from the drop-down list. To allow all VLANs (current or future) to be passed, select **All VLANs**.
  - b. To allow only the set of currently defined VLANs (see [“VLANs” on page 217](#)) to be passed, select **All Current VLANs**. Essentially, this “fixes” the Active VLANs list to contain the currently defined VLANs, and only this set, until you make explicit changes to the Active VLANs list. If you create new VLANs, they will not be passed unless you take action to add them to the list.
  - c. To remove a VLAN from the list of allowed VLANs, click the X before its name.
6. **Mirroring**—Specify one of the active bonds (Bond $x$ ) that is to be mirrored by this bond (Bond $y$ ). ([Figure 104](#)) All wireless traffic received on the AP is transmitted out both Bond $x$  and Bond $y$ . All traffic received

on Bondx is passed on to the onboard processor as well as out Bondy. All traffic received on Bondy is passed on to the onboard processor as well as out Bondx. This allows a network analyzer to be plugged into Bondy to capture traffic for troubleshooting, while the bonded ports provide network connectivity for data traffic.

If each bond contains just one port, then you have the simple case of one port mirroring another.

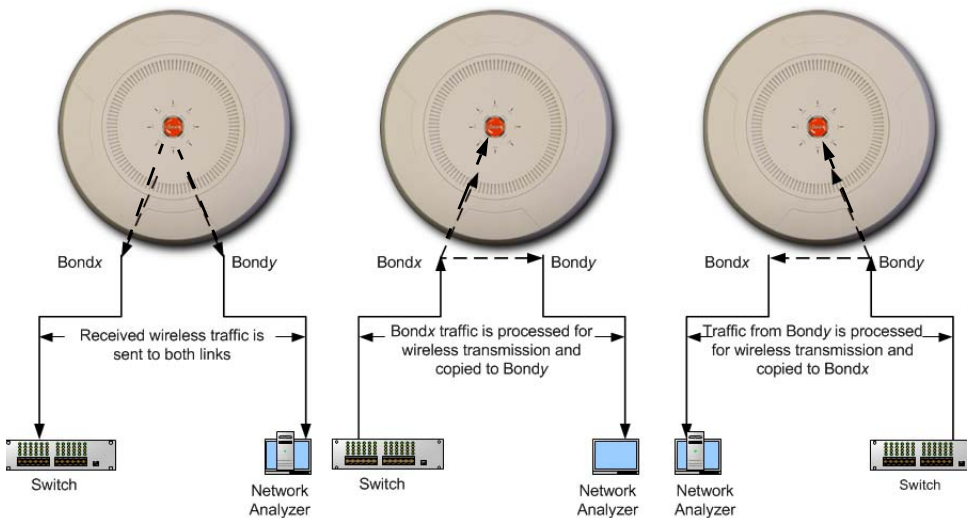



Figure 104. Mirroring Traffic

7. When done configuring bonds and bridging as desired, click the **Save** button  if you wish to make your changes permanent.

### See Also

[Interfaces](#)

[DNS Settings](#)

[Network](#)

[Network Statistics](#)

[Spanning Tree Status](#)

## DNS Settings

This window allows you to establish your **DNS** (Domain Name System) settings. The AP uses these DNS servers to resolve host names into IP addresses. The AP also registers its own Host Name with these DNS servers, so that others may address the AP using its name rather than its IP address. An option allows you to specify that the AP's DNS servers will be assigned via a DHCP server on the wired network.

Note that the DNS servers defined here are not used by wireless clients—servers for stations associated to the AP are defined along with DHCP pools. See “[DHCP Server](#)” on page 204. At least one DNS server must be set up if you want to offer clients associating with the AP the ability to use meaningful host names instead of numerical IP addresses. When finished, click the **Save** button  if you wish to make your changes permanent.



Logged in as: admin

DNS Hostname: FactoryAP

DNS Domain: gateway.2wire.net

DNS Server 1: 192.168.1.254

DNS Server 2:

DNS Server 3:

Use DNS settings assigned by DHCP  On  Off

Figure 105. DNS Settings

### *Procedure for Configuring DNS Servers*

1. **DNS Host Name:** Enter a valid DNS **host name**.
2. **DNS Domain:** Enter the DNS **domain** name.
3. **DNS Server 1:** Enter the IP address of the primary DNS server.
4. **DNS Server 2** and **DNS Server 3:** Enter the IP address of the secondary and tertiary DNS servers (if required).
5. **Use DNS settings assigned by DHCP:** If you are using DHCP to assign the AP's IP address, you may turn this option **On**. The AP will then obtain its DNS domain and server settings from the network DHCP

server that assigns an IP address to the AP, rather than using the DNS Server fields above. You may also configure that DHCP server to assign a host name to the AP.

6. Click the **Save** button  if you wish to make your changes permanent.

### *See Also*

[DHCP Server](#)

[Network](#)

[Interfaces](#)

[Network Statistics](#)

[Spanning Tree Status](#)

### **Cisco Discovery Protocol (CDP) Settings**

CDP is a layer 2 network protocol used to share information (such as the device manufacturer and model, network capabilities, and IP address) with other directly connected network devices. Wireless APs can both advertise their presence by sending CDP announcements, and gather and display information sent by neighbors (see [“CDP List” on page 116](#)).

This window allows you to establish your CDP settings. When finished, use the Save button  if you wish to make your changes permanent.

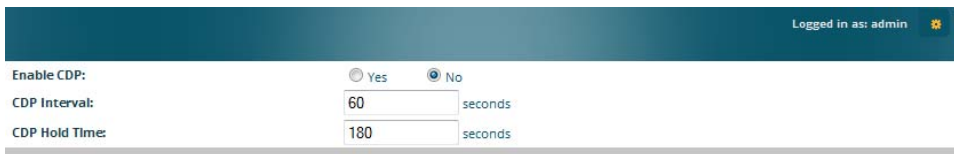

Enable CDP:	<input type="radio"/> Yes	<input checked="" type="radio"/> No
CDP Interval:	<input type="text" value="60"/>	seconds
CDP Hold Time:	<input type="text" value="180"/>	seconds

Figure 106. CDP Settings

### *Procedure for Configuring CDP Settings*

1. **Enable CDP:** When CDP is enabled, the AP sends out CDP announcements of the AP's presence, and gathers CDP data sent by neighbors. When disabled, it does neither. CDP is disabled by default.

2. **CDP Interval:** The AP sends out CDP announcements advertising its presence at this interval. The default is 60 seconds.
3. **CDP Hold Time:** CDP information received from neighbors is retained for this period of time before aging out of the AP's neighbor list. Thus, if a neighbor stops sending announcements, it will no longer appear on the [CDP List](#) window after CDP Hold Time seconds from its last announcement. The default is 180 seconds.

### See Also

[CDP List](#)

[Network](#)

[Interfaces](#)

[Network Statistics](#)

### LLDP Settings

Link Layer Discovery Protocol (LLDP) is a Layer 2 network protocol used to share information (such as the device manufacturer and model, network capabilities, and IP address) with other directly connected network devices. APs can both advertise their presence by sending LLDP announcements, and gather and display information sent by neighbors (see [“LLDP List” on page 117](#)).

This window allows you to establish your LLDP settings. When finished, use the Save button  if you wish to make your changes permanent.

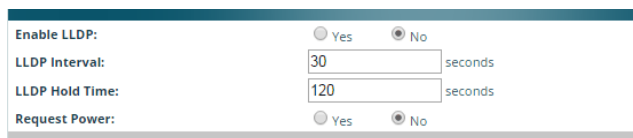

Enable LLDP:	<input type="radio"/> Yes	<input checked="" type="radio"/> No
LLDP Interval:	<input type="text" value="30"/>	seconds
LLDP Hold Time:	<input type="text" value="120"/>	seconds
Request Power:	<input type="radio"/> Yes	<input checked="" type="radio"/> No

Figure 107. LLDP Settings

### *Procedure for Configuring LLDP Settings*

1. **Enable LLDP:** When LLDP is enabled, the AP sends out LLDP announcements of the AP's presence, and gathers LLDP data sent by neighbors. When disabled, it does neither. LLDP is disabled by default.
2. **LLDP Interval:** The AP sends out LLDP announcements advertising its presence at this interval. The default is 30 seconds.
3. **LLDP Hold Time:** LLDP information received from neighbors is retained for this period of time before aging out of the AP's neighbor list. Thus, if a neighbor stops sending announcements, it will no longer appear on the [LLDP List](#) window after LLDP Hold Time seconds from its last announcement. The default is 120 seconds.
4. **Request Power:** You must enable LLDP before enabling this feature. If Request Power is set to **Yes** and LLDP discovers a device port that supplies power to this AP (on a powered switch, for example), the AP checks that the port is able to supply the peak power that is required by this AP model. The Request Power feature does this by requesting this peak power (in watts) from the PoE source, and it expects the PoE source to reply with the amount of power allocated. If the AP does not receive a response confirming that the power allocated by the PoE source is equal to or greater than the power requested, then the AP issues a Syslog message and keeps the radios down for ten minutes. The radios may be enabled manually after this—see [“IAP Settings” on page 319](#).

Using this feature provides a more graceful way of handling an underpowered situation on a Wi-Fi device. When the radios are turned off, XMS can notify you so that you don't have to hunt down an intermittent problem. This feature is disabled by default.

Request Power is available on XR-500/600, XR-2000, and XD4-240 models. It is especially useful for XR-2000 models ending in 5 or 6 (except for the XR-2435/2436), since these models draw PoE+ power levels. Some of these models use Request Power to draw higher power than the IEEE 802.3at maximum of 25.5W. Requested levels are:

XR-2225/2226 (two 2x2 radios) = 22.5W

XR-2235/2236 (two 3x3 radios) = 26.1W

XR-2425/2426 (four 2x2 radios) = 30W

XD4-240/XA4-240 (four 4x4 radios) = 46W

XH2-240 (two 4x4 radios) = 22W

Note that Request Power is not available on the XR-2435/2436. Additionally, it is not available on certain other APs, including these XR Series models: XR-1000, XR-4000, XR-6000, XR-7000.

### *See Also*

[LLDP List](#)

[Network](#)

[Interfaces](#)

[Network Statistics](#)



## Services

This is a status-only window that allows you to review the current settings and status for services on the AP, including DHCP, SNMP, Syslog, and Network Time Protocol (NTP) services. For example, for the DHCP server, it shows each DHCP pool name, whether the pool is enabled, the IP address range, the gateway address, lease times, and the DNS domain being used. There are no configuration options available in this window, but if you are experiencing issues with network services, you may want to print this window for your records.

Time Settings Summary													
NTP Server Status				NTP Server 1 Address				NTP Server 2 Address					
Enabled				time.nist.gov				pool.ntp.org					
Netflow Summary													
State				Collector Host				Collector Port					
Disabled								2055					
System Log Settings Summary													
Log Levels										Log Servers : Ports			
State	Console	Local Lines	Console	Local	1st	2nd	3rd	Email	Primary	Secondary	Tertiary	Email	
on	off	2000	6	7	6	6	6	4	:514	:514	:514	:25	
SNMP Settings Summary													
SNMPv2 State		Trap Auth Failures		Trap Host IP 1		Trap Host IP 2		Trap Host IP 3		Trap Host IP 4			
Enabled		Enabled		Avaya-WOS									
SNMPv3 State		SNMPv3 Security		Trap Port 1		Trap Port 2		Trap Port 3		Trap Port 4			
Disabled		sha / aes		162		162		162		162			
DHCP Server Settings													
DHCP Name	State	NAT	IP Range/Mask	IP Gateway	Default Lease	Maximum Lease	DNS Domain						
WiFi Tag Summary													
State		UDP Port		Tag Channel BG		Ekahau Server							
Disabled		1144		0									
Location Summary													
State				URL				Key		Period			
Disabled										15			

Figure 108. Services

The following sections discuss configuring services on the AP:

- [“Time Settings \(NTP\)” on page 190](#)
- [“NetFlow” on page 193](#)
- [“Wi-Fi Tag” on page 194](#)
- [“Location” on page 195](#)

- “System Log” on page 197
- “SNMP” on page 201
- “DHCP Server” on page 204
- “Proxy Services” on page 206

## Time Settings (NTP)

This window allows you to manage the AP’s time settings, including synchronizing the AP’s clock with a universal clock from an Network Time Protocol (NTP) server. We recommend that you use NTP for proper operation of SNMP in XMS, since a lack of synchronization will cause errors to be detected. Synchronizing the AP’s clock with an NTP server also ensures that Syslog time-stamping is maintained across all units.

It is possible to use authentication with NTP to ensure that you are receiving synchronization from a known source. For example, the instructions for requesting a key for the NIST Authenticated NTP server are available at [http://www.nist.gov/pml/div688/grp00/upload/ntp\\_instructions.pdf](http://www.nist.gov/pml/div688/grp00/upload/ntp_instructions.pdf). The AP allows you to enter optional authentication information.

Configuration Changes are Ready for Saving

Logged in as: admin

Current Access Point Date and Time: Sat May 03 2014 20:59:39

Time Zone: (GMT) Greenwich Mean Time: Dublin, Lisbon, London

Auto Adjust Daylight Savings:  Yes  No

Use Network Time Protocol:  Yes  No

Adjust Time (hrs:min:sec): 8 : 59 : 06 PM

Adjust Date (month/day/year): 05 / 03 / 2014

Figure 109. Time Settings (Manual Time)

### *Procedure for Managing the Time Settings*

1. **Current AP Date and Time:** Shows the current time.
2. **Time Zone:** Select the time zone you want to use (normally your local time zone) from the pull-down list.

3. **Auto Adjust Daylight Savings:** Check this box to have the system adjust for daylight savings automatically, else leave it unchecked (default).
4. **Use Network Time Protocol:** Select whether to set time manually or use NTP to manage system time.
5. **Setting Time Manually**
  - a. **Adjust Time (hrs:min:sec):** If you are not using NTP, use this field if you want to adjust the current system time. Enter a revised time (hours, minutes, seconds, am/pm) in the corresponding fields. Click **Set Time** to apply the changes.
  - b. **Adjust Date (month/day/year):** If you are not using NTP, use this field if you want to adjust the current system date. Enter a revised date (month, day and year) in the corresponding fields. Click **Set Date** to apply the changes.
6. **Using an NTP Server**
  - a. **NTP Primary Server:** If you are using NTP, enter the IP address or domain name of the NTP server.

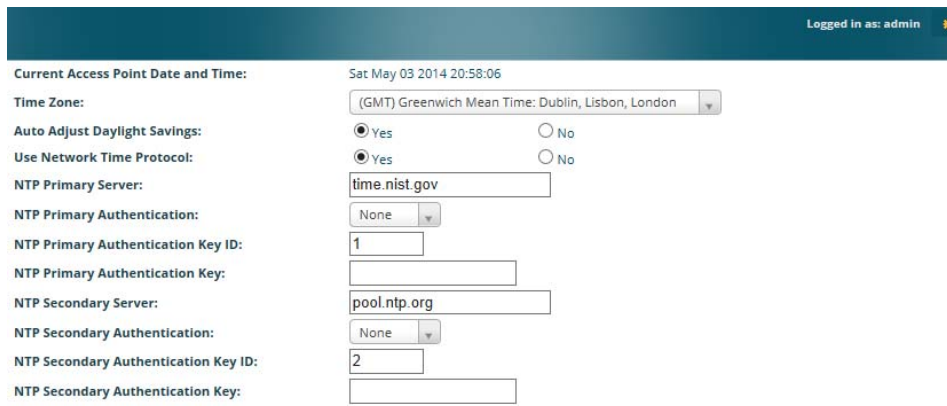

Logged in as: admin

Current Access Point Date and Time: Sat May 03 2014 20:58:06

Time Zone: (GMT) Greenwich Mean Time: Dublin, Lisbon, London

Auto Adjust Daylight Savings:  Yes  No

Use Network Time Protocol:  Yes  No

NTP Primary Server: time.nist.gov

NTP Primary Authentication: None

NTP Primary Authentication Key ID: 1

NTP Primary Authentication Key:

NTP Secondary Server: pool.ntp.org

NTP Secondary Authentication: None

NTP Secondary Authentication Key ID: 2

NTP Secondary Authentication Key:

Figure 110. Time Settings (NTP Time Enabled)

- b. NTP Primary Authentication:** (optional) If you are using authentication with NTP, select the type of key: **MD5** or **SHA1**. Select **None** if you are not using authentication (this is the default).
- c. NTP Primary Authentication Key ID:** Enter the key ID, which is a decimal integer.
- d. NTP Primary Authentication Key:** Enter your key, which is a string of characters.
- e. NTP Secondary Server:** Enter the IP address or domain name of an optional secondary NTP server to be used in case the AP is unable to contact the primary server. You may use the authentication fields as described above if you wish to set up authentication for the secondary server.

*See Also*

[Express Setup](#)

[Services](#)

[SNMP](#)

[System Log](#)

### NetFlow

This window allows you to enable or disable the sending of NetFlow information to a designated collector. NetFlow is a proprietary but open network protocol developed by Cisco Systems for collecting IP traffic information. When NetFlow is enabled, the AP will send IP flow information (traffic statistics) to the designated collector.



Figure 111. NetFlow

NetFlow sends per-flow network traffic information from the AP. Network managers can use a NetFlow collector to view the statistics on a per-flow basis and use this information to make key decisions. Knowing how many packets and bytes are sent to and from certain IP addresses or across specific network interfaces allows administrators to track usage by various areas. Traffic flow information may be used to engineer networks for better performance.

#### *Procedure for Configuring NetFlow*

1. **Enable NetFlow:** Select one of the Netflow versions to enable NetFlow functionality: **v5**, **v9**, or **IPFIX**. Internet Protocol Flow Information Export (IPFIX) is an IETF protocol ([www.ietf.org](http://www.ietf.org)) performing many of the same functions as Netflow. Choose **Disable** if you wish to disable this feature.



*If you select IPFIX, 64 bit counters are supported starting with Release 7.1. IPFIX uses IF-MIB, whose ifXTables support 64 bit counters.*

2. **NetFlow Collector Host (Domain or IP):** If you enabled NetFlow, enter the domain name or IP address of the collector.
3. **NetFlow Collector Port:** If you enabled NetFlow, enter the port on the collector host to which to send data.

## Wi-Fi Tag

This window enables or disables Wi-Fi tag capabilities. When enabled, the AP listens for and collects information about Wi-Fi RFID tags sent on the designated channel. These tags are transmitted by specialized tag devices (for example, AeroScout or Ekahau tags). A Wi-Fi tagging server then queries the AP for a report on the tags that it has received. The Wi-Fi tagging server uses proprietary algorithms to determine locations for devices sending tag signals.

Figure 112. Wi-Fi Tag

### *Procedure for Configuring Wi-Fi Tag*

1. **Enable Wi-Fi Tag:** Choose **Yes** to enable Wi-Fi tag functionality, or choose **No** to disable this feature.
2. **Wi-Fi Tag UDP Port:** If Wi-Fi tagging is enabled, enter the UDP port that the Wi-Fi tagging server will use to query the AP for data. When queried, the AP will send back information on tags it has observed. For each, the AP sends information such as the MAC address of the tag transmitting device, and the RSSI and noise floor observed.
3. **Wi-Fi Tag Channel BG:** If you enabled Wi-Fi tagging, enter the 802.11 channel on which the AP will listen for tags. The tag devices must be set up to transmit on this channel. Only one channel may be configured, and it must be an 802.11b/g channel in the range of Channel 1 to 11.
4. **Ekahau Server:** If you enabled Wi-Fi tagging and you are using an Ekahau server, enter its IP address or hostname. Ekahau Wi-Fi Tag packets received by the AP will be encapsulated as expected by Ekahau, and forwarded to the server.

### Location

The AP offers an integrated capability for capturing and uploading visitor analytics data, eliminating the need to install a standalone sensor network. This data can be used to characterize information such as guest or customer traffic and location, visit duration, and frequency. Use this Location window to configure the AP to send collected data to an analytics server, such as Euclid.

When Location Support is enabled, the AP collects information about stations, including the station ID and manufacturer, time and length of the visit and related time interval statistics, and signal strength and its related statistics. Data collected from stations comprises only basic device information that is broadcast by Wi-Fi enabled devices. Devices that are only detected are included, as well as those that actually connect to the AP. Multiple data points may be sent for a station— data is sent for each IAP that sees a probe request from the station. The AP sending the data also sends its own ID so that the server knows where the visitors were detected. Data messages are uploaded via HTTPS, and they are encrypted if a **Location Customer Key** has been entered. Data is sent as JSON (JavaScript Object Notation) objects, as described in “[Location Service Data Formats](#)” on page 545.

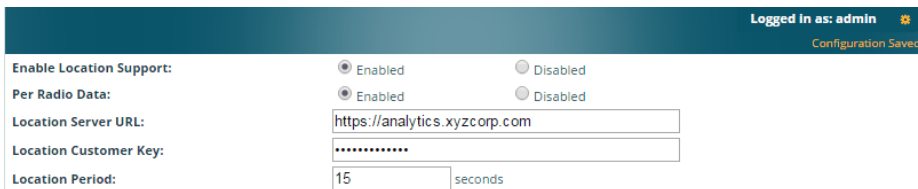

Logged in as: admin	
Configuration Saved	
Enable Location Support:	<input checked="" type="radio"/> Enabled <input type="radio"/> Disabled
Per Radio Data:	<input checked="" type="radio"/> Enabled <input type="radio"/> Disabled
Location Server URL:	<input type="text" value="https://analytics.xyzcorp.com"/>
Location Customer Key:	<input type="text" value="....."/>
Location Period:	<input type="text" value="15"/> seconds

Figure 113. Location

#### *Procedure for Configuring Location*

1. **Enable Location Support:** Choose **Enabled** to enable the collection and upload of visitor analytic data, or choose **Disabled** to disable this feature.
2. **Per Radio Data:** Choose **Enabled** to enable the collection and upload of visitor analytic data on a per-radio basis, or choose **Disabled** to disable this feature.

3. **Location Server URL:** If Location Support is enabled, enter the URL of the location/analytics server. If this URL contains the string **euclid**, then the AP knows that data is destined for a Euclid location server.

For a Euclid analytics server, use the URL that was assigned to you as a customer by Euclid. The AP will send JSON-formatted messages in the form required by Euclid via HTTPS.

For any other location analytics server, enter its URL. The AP will send JSON-formatted messages in the form described in “[Location Service Data Formats](#)” on page 545.

4. **Location Customer Key** (optional):
  - If no string is entered, data is sent unencrypted.
  - If the string **MD5** or **SHA1** is entered, data is sent with that form of encryption. These satisfy the privacy requirements of the EU General Data Protection Regulation (GDPR). In particular, this assures that client device MAC addresses are encrypted when sent.
  - If a Location Customer Key other than MD5 or SHA1 has been entered, data is sent encrypted using AES with that key.
  - The following characters are allowed in the Customer Key—numbers, upper and lower case letters, and these characters:  
~`!@#\$%^&\*()--=+[{}]\|;:'",<.>/
5. **Location Period:** If you enabled Location Support, specify how often data is to be sent to the server, in seconds.



## System Log

This window allows you to enable or disable the Syslog server, define primary, secondary, and tertiary servers, set up email notification, and set the level for Syslog reporting for each server and for email notification—the Syslog service will send Syslog messages at the selected severity or above to the defined Syslog servers and email address. An option allows you to use a Splunk application to analyze AP events by sending data in key:value pairs, as described in “About Using Splunk for Riverbed APs” on page 200.

The screenshot shows a web interface for configuring the System Log. At the top, it says "Configuration Changes are Ready for Saving" and "Logged in as: admin". The main configuration area includes:

- Enable Syslog Server:** Radio buttons for Yes (selected) and No.
- Console Logging:** Radio buttons for Yes and No (selected).
- Local File Size (1-2000 lines):** Text input field with "2000".
- Primary Server Address (Hostname or IP) and Port:** Text input fields for "192.168.1.111" and "514".
- Secondary Server Address (Hostname or IP) and Port:** Text input fields for "192.168.1.112" and "514".
- Tertiary Server Address (Hostname or IP) and Port:** Text input fields for "192.168.1.113" and "514".
- Email Syslog SMTP Server Address (Hostname or IP) and Port:** Text input fields for "mail.xyzcorp.com" and "25".
- Email Syslog SMTP Server User Name:** Text input field with "jsmith".
- Email Syslog SMTP Server User Password:** Password field with masked characters.
- Email Syslog From:** Text input field with "wos\_syslog".
- Email Syslog Recipient Addresses (semicolon delimited):** Text input field with "jsmith@xyzcorp.com".
- Station Formatting:** Radio buttons for Standard (selected) and Key / Value.
- Station URL Logging:** Radio buttons for Enable and Disable (selected).

Below this is a section titled "Syslog Levels" with dropdown menus for:

- Console Logging:** "information and more serious"
- Local File:** "debugging and more serious"
- Primary Server:** "information and more serious"
- Secondary Server:** "information and more serious"
- Tertiary Server:** "information and more serious"
- Email SMTP Server:** "warning and more serious"

Figure 114. System Log

### *Procedure for Configuring Syslog*

1. **Enable Syslog Server:** Choose **Yes** to enable Syslog functionality, or choose **No** to disable this feature.

2. **Console Logging:** If you enabled Syslog, select whether or not to echo Syslog messages to the console as they occur. If you enable console logging, be sure to set the Console Logging level (see [Step 9](#) below).
3. **Local File Size** (1-2000 lines): Enter a value in this field to define how many Syslog records are retained locally on the AP's internal Syslog file. The default is 2000.
4. **Primary Server Address (Hostname or IP) and Port:** If you enabled Syslog, enter the hostname or IP address of the primary Syslog server. You may also change the port used on the server if you do not wish to use 514, the default port.
5. **Secondary/Tertiary Server Address (Hostname or IP) and Port:** (Optional) If you enabled Syslog, you may enter the hostname or IP address of one or two additional Syslog servers to which messages will also be sent. You may also change the port used on each server if you do not wish to use 514, the default port. You may set one of the server addresses to the address of a server for Splunk (see "[About Using Splunk for Riverbed APs](#)" on page 200).
6. **Email Notification:** (Optional) The following parameters allow you to send an email to a designated address each time a Syslog message is generated. The email will include the text of the Syslog message.
  - a. **Email Syslog SMTP Server Address (Hostname or IP) and Port:** The hostname or the IP address of the SMTP server to be used for sending the email. Note that this specifies the mail server, **not** the email recipient. You may also change the port used on the server if you do not wish to use 25, the default SMTP port.
  - b. **Email Syslog SMTP User Name:** Specify a user name for logging in to an account on the mail server designated in [Step a](#).
  - c. **Email Syslog SMTP User Password:** Specify a password for logging in to an account on the mail server designated in [Step a](#).
  - d. **Email Syslog SMTP From:** Specify the "From" email address to be displayed in the email.

- e. Email Syslog SMTP Recipient Addresses:** Specify the entire email address of the recipient of the email notification. You may specify additional recipients by separating the email addresses with semicolons (;).
- 7. Station Formatting:** If you are sending event information to a Splunk server, select **Key/Value** to send data in Splunk's expected format, otherwise leave this at the default value of **Standard**. See [“About Using Splunk for Riverbed APs”](#) on page 200.
- 8. Station URL Logging:** When enabled, Syslog messages are sent for each URL that each station visits. Only HTTP destinations (port 80) are logged; HTTPS destinations (port 443) are not logged. All URLs in a domain are logged, so for example, if an HTTP request to yahoo.com generates requests to 57 other URLs, all are logged. Furthermore, each visit to the same URL generates an additional log message. No deep packet inspection is performed by the URL logging, so no [Application Control](#) information is included in the Syslog message.

The following information is included in the syslog message:

- Date / Time
- Source Device MAC and IP address
- Destination Port
- Destination Site address (e.g., 20.20.20.1)
- The specific URL (e.g., <http://20.20.20.1.24/online/images/img2.jpg>)

Station URL Logging is disabled by default.

- 9. Syslog Levels:** For each of the Syslog destinations, choose your preferred level of Syslog reporting from the pull-down list. Messages with criticality at the selected level and above will be shown. The default level varies depending on the destination.
  - a. Console Logging:** For messages to be echoed to the console, the default level is **Critical and more serious**. This prevents large numbers of non-critical messages from being displayed on the

console. If you set this level too low, the volume of messages may make it very difficult to work with the CLI or view other output on the console.

- b. Local File:** For records to be stored on the AP's internal Syslog file, choose your preferred level of Syslog reporting from the pull-down list. The default level is **Debugging and more serious**.
- c. Primary Server:** Choose the preferred level of Syslog reporting for the primary server. The default level is **Debugging and more serious**.
- d. Secondary/Tertiary Server:** Choose the preferred level of reporting for the secondary/tertiary server. The default level is **Information and more serious**. (Optional)
- e. Email SMTP Server:** Choose the preferred level of Syslog reporting for the email notifications. The default level is **Warning and more serious**. This prevents your mailbox from being filled up with a large number of less severe messages such as informational messages.

10. Click the **Save** button  if you wish to make your changes permanent.

### About Using Splunk for Riverbed APs

Splunk may be used to provide visibility into client experience and analyze usage on APs.

To use Splunk, set up your Splunk server with the Splunk application—available from [apps.splunk.com](https://apps.splunk.com) at [Splunk for Riverbed XR Wireless APs](#). Configure the AP to send data to Splunk by setting a **Primary**, **Secondary**, or **Tertiary Server Address** to the IP address or hostname of your Splunk server. Then set **Station Formatting** to **Key/Value** to send data in Splunk's expected format.

You may specify Server Addresses for Syslog servers and a Splunk server on the same AP. Selecting the **Key/Value** option will not cause any problems with Syslog.

*See Also*  
[System Log](#)

Services

SNMP

Time Settings (NTP)

**SNMP**

This window allows you to enable or disable SNMP v2 and SNMP v3 and define the SNMP parameters. SNMP allows remote management of the AP by the XMS and other SNMP management tools. SNMP v3 was designed to offer much stronger security. You may enable either SNMP version, neither, or both.

The screenshot shows a web-based configuration interface for an XMS device. At the top right, it indicates the user is logged in as 'admin'. The interface is divided into three main sections:

- SNMPv2 Settings:** Includes an 'Enable SNMPv2' checkbox (checked 'Yes'), a 'Read-Write Community String' field (masked with dots), and a 'Read-Only Community String' field (masked with dots).
- SNMPv3 Settings:** Includes an 'Enable SNMPv3' checkbox (checked 'Yes'), 'Authentication' options (SHA selected, MD5 unselected), 'Privacy' options (AES selected, DES unselected), a 'Context Engine ID' field (80005215030007d568780), and fields for 'Read-Write Username' (xirrus-rw), 'Read-Write Authentication Password', 'Read-Write Privacy Password', 'Read-Only Username' (xirrus-ro), 'Read-Only Authentication Password', and 'Read-Only Privacy Password' (all masked).
- SNMP Trap Settings:** Includes four 'Trap Host' IP Address fields (the first is Xirrus-XMS) with corresponding 'Port' fields (all set to 162), a 'Send Auth Failure Traps' checkbox (checked 'Yes'), and a 'Keepalive Trap Interval' field (set to 1).

Figure 115. SNMP

For a summary of traps sent by the AP, see “ArrayOS Traps” on page 539. Complete SNMP details for the AP are found in the Riverbed MIB, available at [support.riverbed.com](http://support.riverbed.com), in the **Downloads** section (login is required to download the MIB).

***NOTE:** If you are managing your APs with XMS (the Xirrus Management System), it is very important to make sure that your SNMP settings match those that you have configured for XMS. XMS uses both SNMP v2 and v3.*

### *Procedure for Configuring SNMP*

#### *SNMPv2 Settings*

- 1. Enable SNMPv2:** Click the checkbox to the left of the **Enabled** label to enable or disable SNMP v2 functionality. When used in conjunction with the Xirrus Management System, SNMP v2 (**not** SNMP v3) must be enabled on each AP to be managed with XMS. The default for this feature is Enabled.
- 2. SNMP Read-Write Community String:** Enter the read-write community string. The default is **xirrus**.
- 3. SNMP Read-Only Community String:** Enter the read-only community string. The default is **xirrus\_read\_only**.

#### *SNMPv3 Settings*

- 4. Enable SNMPv3:** Click the checkbox to the left of the **Enabled** label to enable or disable SNMP v3 functionality. The default for this feature is Disabled.
- 5. Authentication:** Select the desired method for authenticating SNMPv3 packets: Secure Hash Algorithm (**SHA**) or Message Digest Algorithm 5 (**MD5**).
- 6. Privacy:** Select the desired method for encrypting data: Data Encryption Standard (**DES**) or the stronger Advanced Encryption Standard (**AES**).

7. **Context Engine ID:** The unique identifier for this SNMP server. We recommend that you do not change this value. The Context Engine ID must be set if data collection is to be done via a proxy agent. This ID helps the proxy agent to identify the target agent from which data is to be collected.
8. **SNMP Read-Write Username:** Enter the read-write user name. This username and password allow configuration changes to be made on the AP. The default is **xirrus-rw**.
9. **SNMP Read-Write Authentication Password:** Enter the read-write password for authentication (i.e., logging in). The default is **xirrus-rw**.
10. **SNMP Read-Write Privacy Password:** Enter the read-write password for privacy (i.e., a key for encryption). The default is **xirrus-rw**.
11. **SNMP Read-Only Username:** Enter the read-only user name. This username and password do not allow configuration changes to be made on the AP. The default is **xirrus-ro**.
12. **SNMP Read-Only Authentication Password:** Enter the read-only password for authentication (i.e., logging in). The default is **xirrus-ro**.
13. **SNMP Read-Only Privacy Password:** Enter the read-only password for privacy (i.e., a key for encryption). The default is **xirrus-ro**.

### *SNMP Trap Settings*

14. **SNMP Trap Host IP Address:** Enter the **IP Address** or hostname, as well as the **Port** number, of an SNMP management station that is to receive SNMP traps. You may specify up to four hosts that are to receive traps. Note that by default, **Trap Host 1** sends traps to **Riverbed-XMS**. Thus, the AP will automatically communicate its presence to XMS (as long as the network is configured correctly to allow this host name to be resolved—note that DNS is not normally case-sensitive).

For a definition of the traps sent by Riverbed Wireless APs, you may download the Riverbed MIB from [support.riverbed.com](http://support.riverbed.com) (login required). Search for the string **TRAP** in the MIB file.

15. **Send Auth Failure Traps:** Click the checkbox to the left of the **Enabled** label to enable or disable log authentication failure traps.
16. **Keepalive Trap Interval** (minutes): Traps are sent out at this interval to indicate the presence of the AP on the network. Keepalive traps are required for proper operation with XMS. To disable keepalive traps, set the value to 0.
17. Click the **Save** button  if you wish to make your changes permanent.

### See Also

[Services](#)

[System Log](#)

[Time Settings \(NTP\)](#)

## DHCP Server

This window allows you to create, enable, modify and delete **DHCP** (Dynamic Host Configuration Protocol) address pools. DHCP allows the AP to provide wireless clients with IP addresses and other networking information. The DHCP server will not provide DHCP services to the wired side of the network. If you do not use the DHCP server on the AP, then your wired network must be configured to supply DHCP addresses and gateway and DNS server addresses to wireless clients.

When you create a DHCP pool, you must define the **DHCP lease** time (default and maximum), the IP address ranges (pools) that the DHCP server can assign, and the gateway address and DNS servers to be used by clients.



DHCP Pool	On	Lease Time (secs)		NAT	Lease IP Range		Subnet Mask	Gateway	Domain	DNS Servers
		Default	Max		Start	End				

Figure 116. DHCP Management



DHCP usage is determined in several windows—see [SSID Management](#), [Group Management](#), and [VLAN Management](#).

### *Procedure for Configuring the DHCP Server*

1. **New Internal DHCP Pool:** Enter a name for the new DHCP pool, then click on the **Create** button. The new pool ID is added to the list of available DHCP pools. You may create up to 16 DHCP pools (up to 8 on the XR-500 Series).
2. **On:** Click this checkbox to make this pool of addresses available, or clear it to disable the pool.
3. **Lease Time—Default:** This field defines the default [DHCP lease](#) time (in seconds). The factory default is 300 seconds, but you can change the default at any time.
4. **Lease Time—Max:** Enter a value (in seconds) to define the maximum allowable DHCP lease time. The default is 300 seconds.
5. **Network Address Translation (NAT):** Check this box to enable the Network Address Translation feature. The NATed address uses the IP address of the AP's outbound gigabit Ethernet interface.
6. **Lease IP Range—Start:** Enter an IP address to define the start of the IP range that will be used by the DHCP server. The default is 192.168.1.100.
7. **Lease IP Range—End:** Enter an IP address to define the end of the IP range that will be used by the DHCP server. The DHCP server will only use IP addresses that fall between the start and end range that you define on this page. The default is 192.168.1.200.
8. **Subnet Mask:** Enter the subnet mask for this IP range for the DHCP server. The default is 255.255.255.0.
9. **Gateway:** If necessary, enter the IP address of the gateway.
10. **Domain:** Enter the DNS domain name. See [“DNS Settings” on page 184](#).

11. **DNS Servers** (1 to 3): Enter the IP address of the primary DNS server, secondary DNS server and tertiary DNS server. These DNS server addresses will be passed to stations when they associate, along with the assigned IP address. Note that if you leave these blank, no DNS information is sent to the stations. DHCP will **not** default to sending the DNS servers that are configured in DNS Settings. See also, “[DNS Settings](#)” on page 184.
12. Click the **Save** button  if you wish to make your changes permanent.

### See Also

[DHCP Leases](#)  
[DNS Settings](#)  
[Network Map](#)

### Proxy Services



*XR-520/XR-1000 Series APs do not support HTTP/S proxy. You will receive an error message if you attempt to configure this feature.*

If your organization uses a proxy server such as Blue Coat or Netbox Blue to control Internet access, use this page to configure proxy forwarding on the AP. Options are provided for proxying user traffic and AP management traffic.

Proxy services for user traffic are discussed in the following topics:

- “[About Proxy Forwarding](#)” on page 207
- “[Proxy Forwarding for HTTPS](#)” on page 208
- “[Summary of Proxy Forwarding Behavior on the AP](#)” on page 209
- “[Configuring Proxy Forwarding on Clients for HTTPS](#)” on page 210
- “[Procedure for Configuring Proxy Forwarding on the AP](#)” on page 214

Proxy services for management traffic are discussed in the following topics:

- “[About Using a Proxy Client for Management Traffic](#)” on page 214
- “[Procedure for Configuring Proxy Client for Management Traffic](#)” on page 215

## About Proxy Forwarding

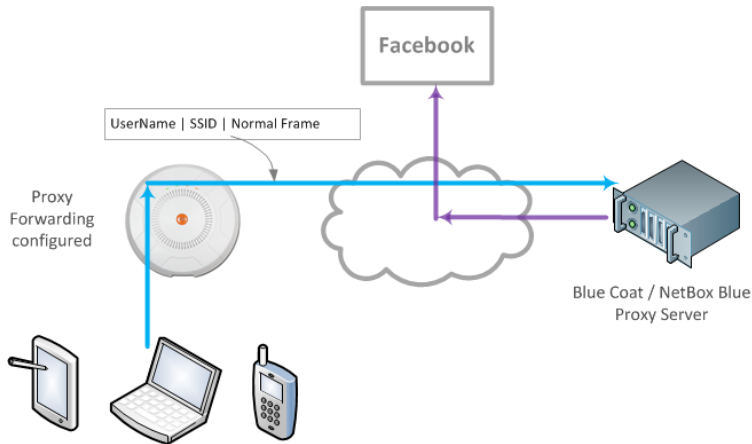

Figure 117. Proxy Forwarding Example

When you configure proxy forwarding settings on the AP, it forwards each HTTP request to the proxy server (for example, Blue Coat) at the specified URL, which checks if the policies that you have set up on the server are satisfied. If so, the proxy server sends the request on to the desired web site. An example is shown in [Figure 117](#). The user of the laptop tries to open Facebook on a browser. The AP forwards this request to the proxy server that you have specified, after adding a prefix with the **user's ID** and the **SSID** (the SSID serves as a user group; for unauthenticated clients, the MAC address serves as the user name). The proxy server checks whether its configured policies permit this access for this user and SSID. If so, the frame is forwarded to the desired web site.



- SSID and client User Name restrictions permit the following characters.*
- Blue Coat permits only alphanumerics and + and /.
  - Netbox Blue permits only alphanumerics and dot, hyphen, underscore, and space characters.

Proxy forwarding on the AP is designed for proxy servers such as Blue Coat and Netbox Blue whose purpose is restricting Internet access to sites, applications and content, and the monitoring and reporting of this activity. It is not used for enhanced performance utilizing content caching.

*Blue Coat policy configuration:*

The AuthConnector utility is not used with the Riverbed implementation. Traffic must first be passed through the portal to dynamically add the User to Blue Coat's list of recognized Users, based on the User header inserted in the packets. When configuring Blue Coat Content Filtering policy, you may select "Users from Reporting". Only the User value can be used in this manner. The Group header value is not dynamically added to Blue Coat's Group list, and it can't be added manually.

*Netbox Blue policy configuration:*

Users and Groups are manually configured on the server. Users are manually assigned to Groups, and policy is applied on a per-Group basis.

Proxy forwarding on the AP is configured as described in "Procedure for Configuring Proxy Forwarding on the AP" on page 214. This proxies all HTTP traffic to the specified server. If you wish to proxy HTTPS traffic as well, you must take the additional steps described below.

### Proxy Forwarding for HTTPS

There are two usage scenarios for proxy forwarding:

- Use proxy forwarding for HTTP traffic only: set up the AP per "Procedure for Configuring Proxy Forwarding on the AP" on page 214. HTTPS traffic is unaffected and proceeds in the usual way.
- Use proxy forwarding for both HTTP and HTTPS traffic: set up the AP per "Procedure for Configuring Proxy Forwarding on the AP" on page 214. Then you must set up browsers on client stations (laptops, smart phones, tablets, ...) to proxy both HTTP and HTTPS traffic to the AP. Each client must also download and install the SSL certificate from the Blue Coat or Netbox Blue proxy server. Follow the procedure below to perform these steps on each client. Note that when a proxy is set up and used for HTTPS, HTTP traffic will also use the proxy server, so configure both as instructed in "Configuring Proxy Forwarding on Clients for HTTPS" on page 210.

### Summary of Proxy Forwarding Behavior on the AP

If proxy forwarding is **not** enabled in the AP and the client browser is **not** configured to use a proxy:

- HTTP traffic (port 80) and HTTPS traffic (port 443) pass transparently through the AP in the usual way.

If proxy forwarding **is** enabled for Blue Coat or Netbox Blue and the client browser is **not** configured to use a proxy (i.e., you do not wish to proxy secure traffic):

- The browser still uses HTTP (port 80) and this traffic is captured and proxied by the AP.
- The browser still uses HTTPS (port 443) and this traffic is passed transparently through the AP.
- If proxy forwarding is not working correctly, HTTP traffic (port 80) is blocked.

If proxy forwarding **is** enabled for Blue Coat or Netbox Blue and the client browser **is** configured to use a proxy:

- The browser is configured to proxy HTTPS to www.xirrus.com port 4388.
- The browser automatically proxies HTTP traffic to the **same** port that is used for HTTPS traffic—port 4388.
- All HTTP/HTTPS traffic is captured by the AP and proxied to Blue Coat or Netbox Blue per your settings.
- If AP proxy forwarding is not working correctly (for example, if the configuration is incorrect), all HTTP/HTTPS/4388 traffic is blocked.

### Configuring Proxy Forwarding on Clients for HTTPS

To set the proxy server on an Apple laptop, skip to [Step 3](#).

1. For Windows laptops, click the desktop **Start** button. In the **Search programs and files** field, enter **Configure proxy server**. The Internet Properties dialog is displayed. ([Figure 118](#)) Click the **LAN Settings** button. The Local Area Network dialog displays.

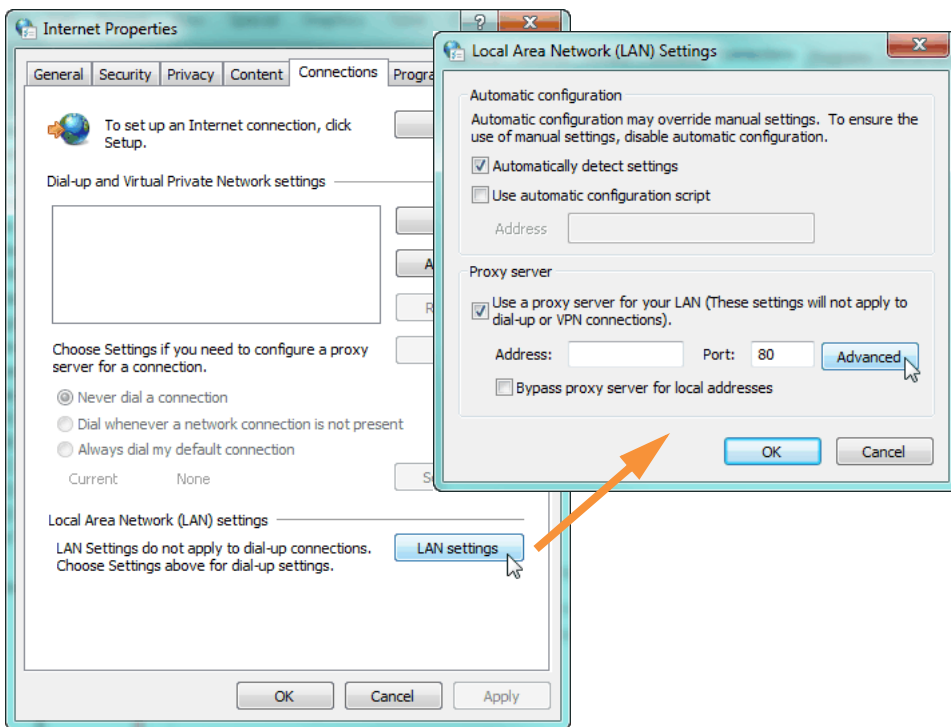

Figure 118. Set up a Proxy Server on each Client (Windows)

2. In the Proxy Server section, click the **Advanced** button. The Proxy Settings dialog displays. ([Figure 119](#))

For **HTTPS**: Enter any valid address, such as your company's web site in the **Proxy address to use** field. For example, **www.xyzcorp.com** as shown in [Figure 115](#). This field is not actually used, but Windows needs it to be a

valid address or domain name. You **must** set the **Port** to **4388**. This is **very important!** This is the AP port that should receive all HTTPS traffic if you are using a proxy server.

For **HTTP**: HTTP traffic will automatically use the same port that you have configured for HTTPS: 4388. We suggest that you enter your company's web site, **Port 4388** here to make it obvious that HTTP traffic is being proxied in this way.

Continue to [Step 5](#).

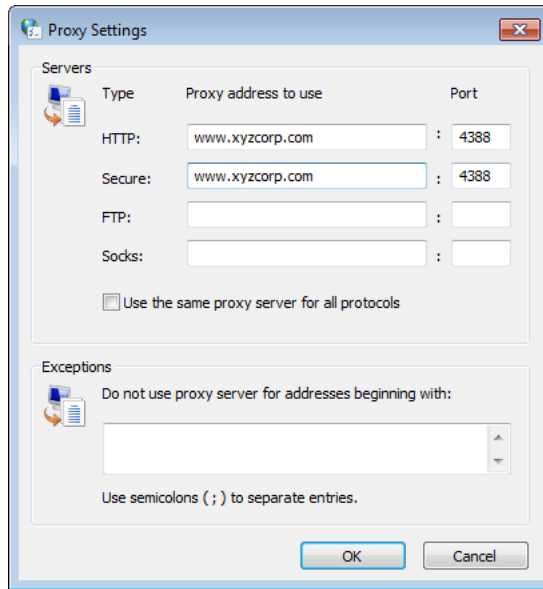

Figure 119. Specify Proxy Servers (Windows)

- For Apple laptops, open **System Preferences** and select **Network**. The Network dialog is displayed. (Figure 120) Click the **Advanced** button.

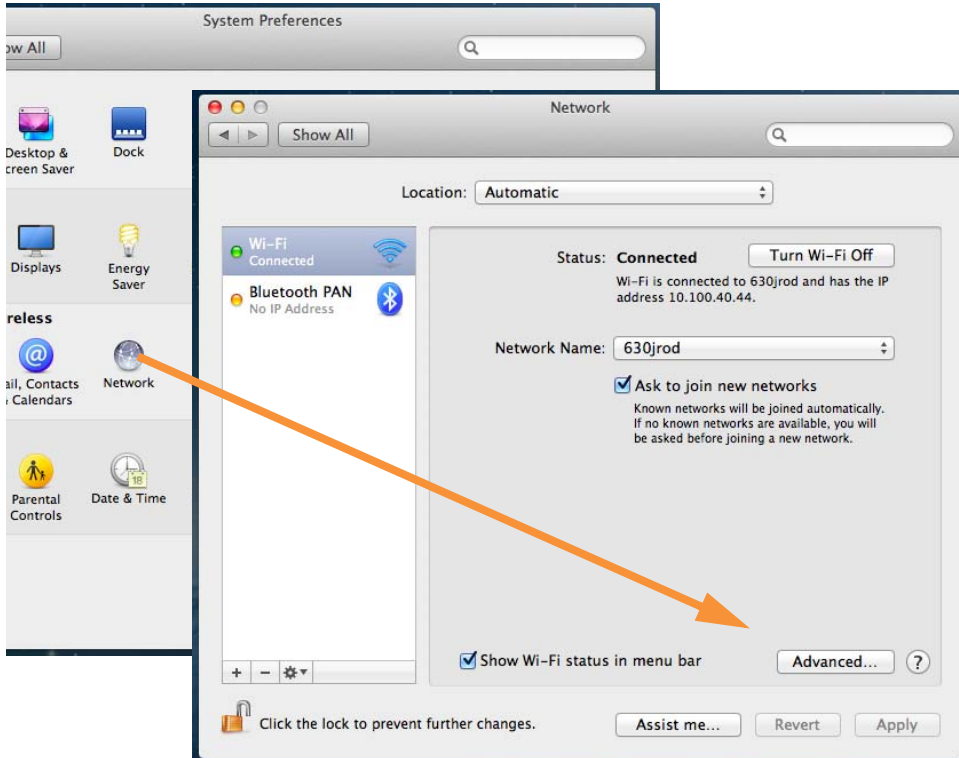

Figure 120. Set up a Proxy Server on each Client (Apple)

- Select the **Proxies** tab. (Figure 121)

Check **Secure Web Proxy (HTTPS)**: Under **Secure Web Proxy Server**, you can enter any valid address. We suggest that you enter **www.xirrus.com**. (This field is not actually used, but it must be a valid address or domain name). You **must** set the **Port** to **4388**. This is **very** important! This is the AP port that must receive all HTTPS traffic if you are using a proxy server for HTTPS.



Check **Web Proxy (HTTP)**: Under **Web Proxy Server**, we suggest that you enter **www.xirrus.com Port 4388** to make it obvious that HTTP traffic is being proxied in this way.

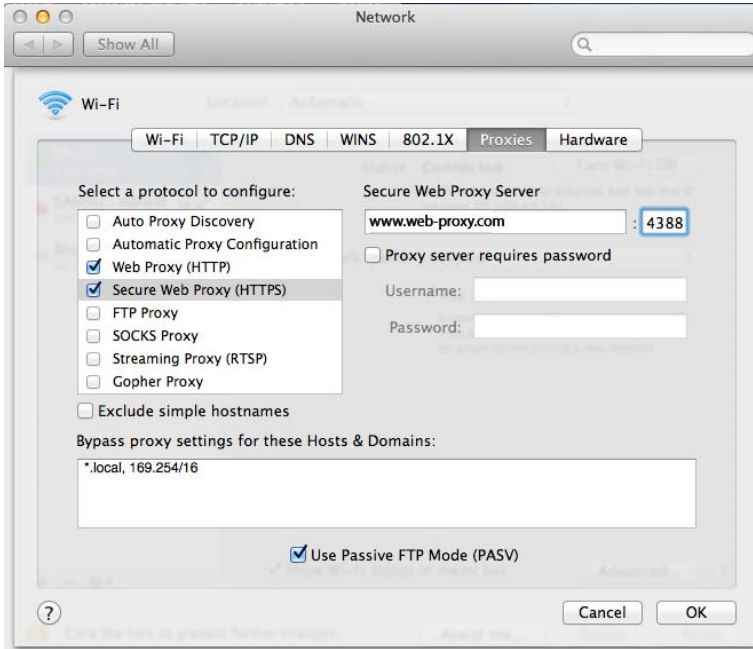

Figure 121. Specify Proxy Servers (Apple)

5. **SSL Certificate**: you must download and install the security certificate from your proxy server—Blue Coat or Netbox Blue. It must be installed on each of your client devices.

### Procedure for Configuring Proxy Forwarding on the AP

1. **Enable:** If you wish to use proxy forwarding, select the proxy server type—**Blue Coat** or **Netbox Blue**.

The screenshot shows a web interface for configuring proxy forwarding. At the top right, it says "Logged in as: admin" and "Proxy Forward Information Loaded". The main section is titled "Proxy Forwarding" and contains the following configuration options:

- Enable:** Three radio buttons are present: "Off" (selected), "BlueCoat", and "NetBoxBlue".
- BlueCoat URL:** A text input field containing "proxy.threatpulse.net".
- NetBox Blue URL:** A text input field containing "xirrus.netboxblue.com".

Figure 122. Proxy Forwarding

2. **BlueCoat URL:** If you selected **Blue Coat** above, enter the URL of the proxy server, for example, **http://proxy.threatpulse.net**.
3. **Netbox Blue URL:** If you selected **Netbox Blue** above, enter the actual URL of the proxy server, for example, **xirrus.netboxblue.com**. Note that this default URL is not an actual proxy server—this prevents you from unintentionally forwarding traffic.

### About Using a Proxy Client for Management Traffic

Some deployments require that all Internet traffic, including management traffic, use proxy services. For instance, some school systems require *all* traffic to use a proxy server. The AP generates management traffic to implement essential functions such as licensing/activation, XMS-Cloud configuration, and XMS Guest Access authentication. The AP allows you to configure clients that are used to proxy such management traffic.

If your deployment requires proxying the AP's management traffic, rather than allowing that traffic to go directly out to the Internet, you will need to configure the following clients:

- **HTTP and HTTPS:** This traffic sends traps and fetches configurations from XMS. If you are using the XMS-Cloud Guest Access service, this also uses the HTTPS proxy client. You must enter the IP address and subnet

mask of the proxy server. If this server requires authentication, you may enter a user name and password as well.

- **SOCKS:** Other management functions use this form of socket to send traffic. For example, this socket is used by the XMS-Cloud configuration service which communicates with the XMS-Cloud using web sockets. Currently, two versions of SOCKS are broadly used on the Internet – Version 4 and Version 5. The service defaults to Version 5 if no version is declared.

The SOCKS proxy client requires a whitelist of networks that will not be proxied. At the least, this must include the loopback address and the subnet where the proxy server lives. Additional defined subnets should include DNS servers and authentication servers.

### *Procedure for Configuring Proxy Client for Management Traffic*

1. **Enable:** For each proxy client, you must **Enable** it if you wish to use it.

Type	Enable	IP Address	Port	Username	Password	
HTTP	<input type="checkbox"/>	192.168.254.2	3128	proxyuser	proxypass	Reset
HTTPS	<input type="checkbox"/>	192.168.254.2	3128	proxyuser	proxypass	Reset
SOCKS 5	<input type="checkbox"/>	192.168.254.2	1080	proxyuser	proxypass	Reset

Socks Network Whitelist

Network	Mask
<input type="text" value="192.168.1.0"/>	<input type="text" value="255.255.255.0"/>

(10 additional local socks subnets can be configured)

Figure 123. Proxy Client for Management Traffic

2. **IP Address/Port:** For each proxy client, enter the IP Address and Port of the proxy server. For the **HTTP** and **HTTPS** proxy clients, you may specify a fully qualified domain name (FQDN) or an IP address. For

SOCKS, an FQDN is not allowed—an IP address is required. The default Port settings are standard defaults for these ports.

3. **Username/Password:** For each proxy client, if the proxy server requires authentication, enter the Username and Password here.
4. **SOCKS 4/ SOCKS 5:** Select the version of SOCKS in use on your proxy server. The default is SOCKS 5.
5. **Socks Network Whitelist:** Enter a whitelist of subnetworks that must not be proxied. Specify each subnet by entering its **Network** address and its subnet **Mask**, then click **Add**. At the least, create entries for the loopback address and the subnet where the proxy server lives. You should also enter subnets that include your DNS servers and authentication servers.

## VLANs

This is a status-only window that allows you to review the current status of configured VLANs and VLAN Pools. VLANs are virtual LANs used to create broadcast domains. VLAN pools are provided for special situations where clients are to be assigned one of a set of VLANs that are treated as a pool. See “VLAN Pools” on page 219.



*You should create VLAN entries on the AP for all of the VLANs in your wired network if you wish to make traffic from those VLANs available on the wireless network. Each tagged VLAN should be associated with a wireless SSID (see “VLAN Management” on page 221). The AP will discard any VLAN-tagged packets arriving on its wired ports, unless the same VLAN has been defined on the AP. See “Undefined VLANs” on page 118.*

In addition to listing all VLANs, this window shows your settings for the Default Route VLAN and the Native (Untagged) VLAN ([Step 1 page 222](#)).

VLAN Summary									
Vlan Name	Number	Management	Roaming	Active	DHCP				
					State	IP Address	Subnet Mask	Gateway	
Administration	30	disabled	disabled	false	disabled				
Faculty	40	disabled	disabled	false	disabled				
VLAN-3101	3101	disabled	disabled	false	disabled				
VLAN-3102	3102	disabled	disabled	false	disabled				
VLAN-3103	3103	disabled	disabled	false	disabled				
VLAN-3104	3104	disabled	disabled	false	disabled				

VLAN Pools			
Pool	VLAN ID	VLAN Name	
- VLAN-PoolA - 4 item(s)			
VLAN-PoolA	3101	VLAN-3101	
VLAN-PoolA	3102	VLAN-3102	
VLAN-PoolA	3103	VLAN-3103	
VLAN-PoolA	3104	VLAN-3104	

Figure 124. VLANs

## Understanding Virtual Tunnels

Riverbed APs support Layer 2 tunneling. This allows an AP to use tunnels to transport traffic for one or more SSID-VLAN pairs onto a single destination network through the Layer 3 core network. Tunnels may be implemented with:

- The Riverbed Tunnel Server (XTS)—see the *Riverbed Tunnel Server User's Guide*.
- [Virtual Tunnel Server \(VTS\)](#)—see below.

You may specify a tunnel for a VLAN as described below and in [“Procedure for Managing VLANs” on page 222](#). These tunnels are typically set up to be encrypted. Alternatively, the GRE tunnels created in [“Tunnel Management” on page 226](#) are not encrypted, offering much higher throughput and improved scaling. If tunneled traffic is not traversing public networks, GRE is recommended. While VLAN tunnels and GRE can be used on the same AP simultaneously, more than one tunnel shouldn't be configured to tunnel the same traffic.

### *Virtual Tunnel Server (VTS)*

Tunneling capability is provided by a Virtual Tunnel Server. You supply the server and deploy it in your network using open-source VTun software, available from [vtun.sourceforge.net](http://vtun.sourceforge.net). To enable the AP to use tunneling for a VLAN, simply enter the IP address, port and secret for the tunnel server as described in [Step 12 on page 224](#).

VTun may be configured for a number of different tunnel types, protocols, and encryption types. For use with APs, we recommend the following configuration choices:

- Tunnel Type: Ether (Ethernet tunnel)
- Protocol: UDP
- Encryption Type: select one of the encryption types supported by VTun (AES and Blowfish options are available)
- Keepalive: yes

### ***VTS Client-Server Interaction***

The AP is a client of the Virtual Tunnel Server. When you specify a VTS for an active VLAN-SSID pair, the AP contacts the VTS. The server then creates a tunnel session to the AP. VTun encapsulated packets will cross the Layer 3 network from the AP to the VTS. When packets arrive at the VTS, they will be de-encapsulated and the resultant packets will be passed to your switch with 802.1q VLAN tags for final Layer 2 processing. The process occurs in reverse for packets traveling in the other direction.

We recommend that you enable the VTun keep-alive option. This will send a keep-alive packet once per second to ensure that the tunnel remains active. Tunnels can be configured to come up on demand but this is a poor choice for wireless, since tunnel setup can take roughly 5-20 seconds and present a problem for authentication.

### **VLAN Pools**

A VLAN pool is a set of VLANs. Using a pool allows a client associating to an AP to be assigned to one of the VLANs in the pool rather than to a particular VLAN. This is useful in special networking situations. For example, a large hotel uses four Internet access gateways to capture Wi-Fi users. Each gateway uses one VLAN. On the hotel's APs, we create a VLAN pool with the four gateway VLANs. When a client connects to an AP, it is assigned to one of the VLANs in the pool. This distributes users approximately evenly among the gateways, roughly balancing their loads.

Each client device is assigned to a pool VLAN with a computation based on the lower digits of its MAC address, so that the device will always be assigned to the same VLAN. This ensures that a client roaming from one AP to the next will be handled properly. Note that the VLAN assigned is also based on the VLANs in the pool, so that if changes are made to the pool, the client device may be assigned to a different VLAN.

You may specify a VLAN pool rather than a particular VLAN for SSIDs or for user groups. See [“Procedure for Managing SSIDs” on page 284](#) or [“Procedure for Managing Groups” on page 312](#).

You may create up to 16 VLAN pools, and each may contain up to the maximum number of VLANs that may be created on the AP. If a user has a VLAN assigned via RADIUS authentication, then this VLAN will be used rather than one from the VLAN pool. If a user has a VLAN assigned via a [Group](#), then this VLAN will be used rather than one from the VLAN pool.

To set up a VLAN pool, see the next section.



## VLAN Management

This window allows you to set up VLANs and VLAN Pools. After creating a new VLAN (added to the list of VLANs), you can modify the configuration parameters of an existing VLAN or delete a selected VLAN. For ArrayOS 6.6 and later releases, you may create up to 64 VLANs (up to 32 on XR-520).

Default Route:

Native VLAN:

---

**VLAN Pools** Reset All VLAN Pools

Create New Pool:

---

**VLANs** Reset All VLANs

Create New VLAN:  ID:

VLAN Information	Management	FastRoaming	Tunnel Server	DHCP
100 100	Off	Off	None defined	disabled

VLAN: 100 (100)

Allow Management:  Disabled

Fast Roaming:  Disabled

DHCP:  Disabled IP:  Mask:  Gateway:

Tunnel: Server:  Port:  Secret:   Encrypt

VLAN Information	Management	FastRoaming	Tunnel Server	DHCP
200 200	Off	Off	None defined	disabled
VLAN Information	Management	FastRoaming	Tunnel Server	DHCP
210 210	Off	Off	None defined	disabled

Figure 125. VLAN Management



The Wireless AP supports dynamic VLAN assignments specified by RADIUS policy settings. When RADIUS sends these assignments, the AP dynamically assigns wireless stations to VLANs as requested. VLAN tags on traffic are passed through the AP (i.e., VLAN tags are not stripped). Once a station has been dynamically moved to a new VLAN, it will be shown in the Stations window as a member of the new VLAN. (Figure 69 on page 131)

It is critical to configure all VLANs to be used on the AP, even those that will be dynamically assigned.

### Procedure for Managing VLANs

- 1. Default Route:** This option sets a default route from the AP. The AP supports a default route on native and tagged interfaces. Once the default route is configured the AP will attempt to use Address Resolution Protocol (ARP) to find the default router. ARP finds the MAC address of a device with a given IP address by sending out a broadcast message requesting this information. This option allows you to choose a default VLAN route from the pull-down list. The IP Gateway must be established for this function to work. After changing the **Default Route**, you *must* click the **Save** button  and then reboot.
- 2. Native VLAN:** This option sets whether the AP management is tagged or untagged. If you select a Native VLAN, then that VLAN will use an untagged (Native) link. Otherwise, the AP will use 802.1Q tagging and a specific VLAN ID with management enabled for management of the AP.

### VLAN Pools

- 3.** See “VLAN Pools” on page 219 for a discussion of VLAN pools. To add a new pool, type its name in **Create New Pool**, and click ENTER. The new VLAN pool entry is added to the list.

4. First, create all of the VLANs that will belong to this pool. See [Step 5](#) below.

Click in the field for the new pool to display a list of VLANs. Add the desired VLANs to this pool, one at a time. This field also provides a search feature—type in a string, and a list will display all VLANs whose names contain that string in any position (VLAN names are searched, but not VLAN numbers). Click the **Apply** button on the right when done adding VLANs. Note that the same VLAN can be added to more than one pool. Be sure to consider any network implications of using the same VLAN in multiple pools.

Click **Reset** if you want to remove all of the VLANs from this pool, i.e., to empty it. Click **Remove** to delete this pool. You may use **Reset All Pools** on the bottom to delete all pools.

### VLANs

5. **Create New VLAN:** Enter a name for the new VLAN in this field. **ID:** Enter a number for this VLAN (0-4094). Click the **Create VLAN** button. The new VLAN appears in the list. Entries are sorted alphabetically by VLAN name. Select the new entry to modify any of the settings below.
6. **Management:** Move the slider if you want to allow AP management over this VLAN.
7. **Fast Roaming:** Move the slider if you want to allow roaming over this VLAN.
8. **DHCP:** Move the slider if you want the DHCP server to assign the IP address, subnet mask and gateway address for this VLAN automatically, otherwise you must go to the next step and assign these parameters manually.
9. **IP Address:** If the DHCP option is disabled, enter a valid IP address for this VLAN association.
10. **Subnet Mask:** If the DHCP option is disabled, enter the subnet mask IP address for this VLAN association.

11. **Gateway:** If the DHCP option is disabled, enter the IP gateway address for this VLAN association.
12. **Tunnel Server:** If this VLAN is to be tunneled, enter the IP address or host name of the tunnel server that will perform the tunneling. For more information on virtual tunnels, please see [“Understanding Virtual Tunnels”](#) on page 218.
13. **Tunnel Server Port:** If this VLAN is to be tunneled, enter the port number of the tunnel server.
14. **New Secret:** Enter the password expected by the tunnel server.
15. **Delete VLAN:** To delete the selected VLAN, simply click the **Delete** button to remove the VLAN from the list.
16. Click the **Save** button  if you wish to make your changes permanent.

*See Also*

[VLAN Statistics](#)

[VLANs](#)

[Tunnels](#)

## Tunnels

This read-only window allows you to review the tunnels that have been defined on the AP. It lists all tunnels and their settings, including the type of authentication and the local and remote endpoints for each tunnel.

Tunnels are discussed in these sections:

- [About Riverbed Tunnels](#)
- [Tunnel Management](#)
- [SSID Assignments](#)
- [VLAN Assignments](#)

Tunnel Name	Enabled	Type	SSID	Local Endpoint	Primary Remote Endpoint	Secondary Remote Endpoint	DHCP Option	Failover		
								MTU	Interval	Failures
Central	disabled	none	none				disabled	1458	10	6

Figure 126. Tunnel Summary

### About Riverbed Tunnels

Riverbed APs offer GRE (Generic Routing Encapsulation) tunneling with VLAN support. This allows an AP to use tunnels to bridge Layer 2 traffic for one or more SSIDs onto a single destination network through the Layer 3 network. You may specify particular VLANs on an SSID to be tunneled, or tunnel all of the VLANs that are on this SSID. GRE tunneling is quite flexible, and can encapsulate many network layer protocols. As a result, it can support a variety of applications. For example, a Wi-Fi hotspot can allow guest logins and use the tunnel to give guests direct access to the Internet, without allowing access to the local network. In a small office, you may define a tunnel to connect users to the corporate office network. Tunnels may also be used when providing cellular offload capability. For non-GRE tunnels associated with particular VLANs, see [“Understanding Virtual Tunnels” on page 218](#).

Tunnels may be implemented with:

- The Riverbed Tunnel Server (XTS)—see the Riverbed *Tunnel Server User's Guide*.
- VTS—see “[Virtual Tunnel Server \(VTS\)](#)” on page 218.

To create a tunnel, you specify the **Local Endpoint**, which should be one of the AP's wired ports, and the **Primary Remote Endpoint**. A **Secondary Remote Endpoint** may also be specified in case of a failure at the first endpoint. Traffic for the designated VLANs on an SSID is sent in GRE encapsulated packets across the Layer 3 network from the AP to the remote endpoint. When packets arrive, the encapsulation is stripped and the resultant packets are passed to your switch with 802.1q VLAN tags for final Layer 2 processing. The process occurs in reverse for packets traveling in the other direction.

## Tunnel Management

This window allows you to create tunnels.

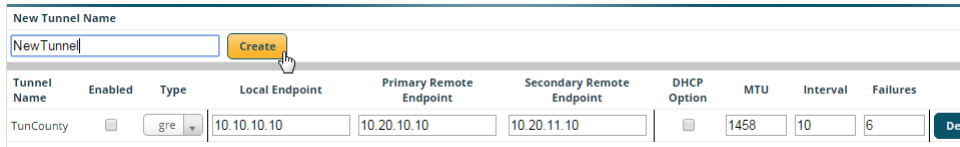

The screenshot shows a web interface for tunnel management. At the top, there is a form to create a new tunnel. It includes a text input field for 'New Tunnel Name' containing 'NewTunnel', a 'Create' button, and a 'Type' dropdown menu set to 'gre'. Below the form is a table listing existing tunnels.

Tunnel Name	Enabled	Type	Local Endpoint	Primary Remote Endpoint	Secondary Remote Endpoint	DHCP Option	MTU	Interval	Failures	
TunCountry	<input type="checkbox"/>	gre	10.10.10.10	10.20.10.10	10.20.11.10	<input type="checkbox"/>	1458	10	6	Del

Figure 127. Tunnel Management

### Procedure for Managing Tunnels

1. **New Tunnel Name:** Enter a name for the new tunnel in this field, then click on the **Create** button. The new tunnel is added to the list. You may create up to 250 Layer 3 tunnels.
2. **Enabled:** The new tunnel is created in the disabled state. Click this checkbox to enable it.
3. **Type:** Enter the type of tunnel, **none** or **gre**.
4. **Local Endpoint:** Enter the IP address of the AP Gigabit or 10 Gigabit port where the tunnel is to begin.

- 5. Primary Remote Endpoint:** Enter the IP address of the remote endpoint of the tunnel.
- 6. Secondary Remote Endpoint:** This provides a failover capability. If the primary tunnel fails, traffic is switched over to the secondary tunnel. Enter the IP address of the remote endpoint of the secondary tunnel.
- 7. DHCP Option:** When this option is enabled, the AP snoops station DHCP requests and inserts relay agent information (Option 82, in the CIRCUIT-ID sub-option) into these DHCP packets. Information inserted includes AP BSSID, SSID name, and SSID encryption type. You may use this option here or on the [SSID Management](#) page, but not in both places. Information is inserted as a colon-separated text string in the CIRCUIT ID value field in this format: [AP\_MAC];[SSID];[ENC]

[AP\_MAC] length = 17 (aa:bb:cc:dd:ee:ff)

[SSID] length = length of SSID name

[ENC] length = 1 (encryption type: 'o' = open, 's' = non-open)

Note that this is a different format than is used for Option 82 with SSIDs.

- 8. MTU:** Set maximum transmission unit (MTU) size.
- 9. Interval:** The tunnel mechanism will ping the current remote endpoint periodically to ensure that it is still reachable. Enter the ping interval (in seconds).
- 10. Failures:** Enter the number of consecutive ping failures that will cause the AP to consider the tunnel to be down. tunnel to failover to the other remote endpoint.
- 11.** Click the **Save** button  if you wish to make your changes permanent.
- 12.** Proceed to [SSID Assignments](#) to define the SSIDs for which each tunnel will bridge data. You may create up to 16 tunnels. Assign one or more SSIDs to each tunnel. You may restrict the tunnel to handling traffic for particular VLANs on each SSID if you wish, as described in [VLAN Assignments](#).

## SSID Assignments

This window allows you to select the SSIDs to be bridged by each tunnel. Station traffic for SSIDs assigned will be bridged through the tunnel, but you may restrict which VLANs are tunneled for each SSID (see [VLAN Assignments](#), below). By default, all VLANs will be tunneled. When VLAN traffic is tunneled, it will be tagged accordingly.

SSID Assignments				
TUNNEL	County	Public	SS1	ALL SS
TunCounty	<input checked="" type="checkbox"/>	<input type="checkbox"/>	<input type="checkbox"/>	<input type="checkbox"/>

Figure 128. Tunnel SSID Assignments

### *Procedure for Assigning SSIDs*

This window lists the tunnels and SSIDs that you have defined.

1. For each tunnel, select the SSIDs that are to be bridged to the remote endpoint. Clear the checkbox for any SSID that you no longer wish to include in the tunnel. You may use the **ALL SSIDs** checkbox to toggle between selecting all SSIDs, or none.
2. Click the **Save** button  to make your changes permanent.



## VLAN Assignments

When you assign an SSID to a tunnel, all VLANs on that SSID will be transported to the tunnel by default. This window allows you to select specific VLANs to be bridged by each tunnel. A VLAN's station traffic bridged through a tunnel will be tagged accordingly. Station traffic for a VLAN that is not tunneled is forwarded to the local subnet, i.e., dropped off locally at the edge of the switch network to which the AP is connected.

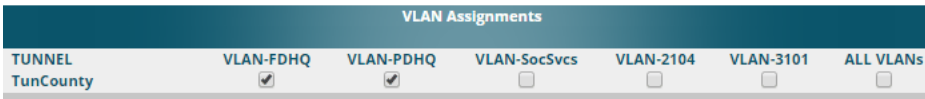

TUNNEL	VLAN-FDHQ	VLAN-PDHQ	VLAN-SocSvcs	VLAN-2104	VLAN-3101	ALL VLANs
TunCounty	<input checked="" type="checkbox"/>	<input checked="" type="checkbox"/>	<input type="checkbox"/>	<input type="checkbox"/>	<input type="checkbox"/>	<input type="checkbox"/>

Figure 129. Tunnel VLAN Assignments

### *Procedure for Assigning SSIDs*

This window lists the tunnels and VLANs that you have defined.

1. For each tunnel, select the VLANs that are to be bridged to the remote endpoint. Clear the checkbox for any VLAN that you no longer wish to include in the tunnel. You may use the **ALL VLANs** checkbox to toggle between selecting all VLANs, or none. Note that if you add any VLANs to this list, then they will be the **only** VLANs transported on this tunnel. Also note that many VLANs may be in use on an SSID if they are assigned to stations dynamically by a RADIUS server or by user groups (see “Groups” on page 310).
2. Click the **Save** button  to make your changes permanent.

### *See Also*

[Tunnels](#)

[VLANs](#)

[SSIDs](#)

## Security

This status-only window allows you to review the AP's security parameters. It includes the assigned network administration accounts, Access Control List (ACL) values, management settings, encryption and authentication protocol settings, and RADIUS configuration settings. There are no configuration options available in this window, but if you are experiencing issues with security, you may want to print this window for your records.

Administration									
Accounts	Level 0	Level 1	Level 2	Level 3	Level 4	Level 5	Level 6	Level 7	Level 8
1	0	1	0	0	0	0	0	0	0
Access Control List									
Enabled		Entries			List Type				
No		0			N/A				
Management Control									
SSH Enabled		Telnet Enabled		HTTPS Enabled		Avaya Virtual Console Enabled		Console Enabled	
Yes		No		Yes		Yes		N/A	
Global Security									
TKIP Enabled		AES Enabled			PSK Enabled		EAP Enabled		
No		Yes			No		Yes		
Radius									
Server In Use		External Primary Server		External Primary Port		External DAS Port		Internal Radius Users	
external-radius				1812		3799		0	

Figure 130. Security

For additional information about wireless network security, refer to:

- [“Security Planning” on page 60](#)
- [“Understanding Security” on page 231](#)
- [The Security section of “Frequently Asked Questions” on page 532](#)

For information about secure use of the WMI, refer to:

- [“Certificates and Connecting Securely to the WMI” on page 234](#)
- [“Using the AP’s Default Certificate” on page 235](#)
- [“Using an External Certificate Authority” on page 236](#)
- [“About Creating Admin Accounts on the RADIUS Server” on page 240](#)

- [“About Creating User Accounts on the RADIUS Server” on page 260](#)

Security settings are configured with the following windows:

- [“Admin Management” on page 236](#)
- [“Admin Privileges” on page 238](#)
- [“Admin RADIUS” on page 240](#)
- [“Management Control” on page 243](#)
- [“Access Control List” on page 253](#)
- [“Global Settings” on page 255](#)
- [“External Radius” on page 259](#)
- [“Internal Radius” on page 264](#)
- [“Active Directory” on page 266](#)
- [“Rogue Control List” on page 270](#)
- [“OAuth 2.0 Management” on page 271](#)

### Understanding Security

The Riverbed Wireless AP incorporates many configurable security features. After initially installing an AP, always change the default administrator password (the default is admin), and choose a strong replacement password (containing letters, numbers and special characters). When appropriate, issue read-only administrator accounts.

Other security considerations include:

- **SSH versus Telnet:** Be aware that Telnet is not secure over network connections and should be used only with a direct serial port connection. When connecting to the unit’s Command Line Interface (CLI) over a network connection, you must use a Secure SHell version 2 (SSH-2) utility. SSH-2 provides stronger security than SSH-1. The most commonly used freeware providing SSH tools is PuTTY.
- **Configuration auditing:** The optional XMS offers powerful management features for small or large wireless deployments, and can audit your configuration settings automatically. In addition, using the XMS eliminates the need for an FTP server.

- **Choosing an encryption method:** Wireless data encryption prevents eavesdropping on data being transmitted or received over the airwaves. The AP allows you to establish the following data encryption configuration options:
  - **Open**—this option offers no data encryption and is not recommended, though you might choose this option if clients are required to use a VPN connection through a secure SSH utility, like PuTTY.
  - **Wired Equivalent Privacy (WEP)**—this option provides minimal protection (though much better than using an open network). An early standard for wireless data encryption and supported by all Wi-Fi certified equipment, WEP is vulnerable to hacking and is therefore not recommended for use by Enterprise networks.
  - **Wi-Fi Protected Access (WPA and WPA2)**—these are much stronger encryption modes than WEP, using Temporal Key Integrity Protocol (TKIP) or Advanced Encryption Standard (AES) to encrypt data.

WPA solves security issues with WEP. It also allows you to establish encryption keys on a per-user-basis, with key rotation for added security. In addition, TKIP provides Message Integrity Check (MIC) functionality and prevents active attacks on the wireless network.

AES is the strongest encryption standard and is used by government agencies; however, old legacy hardware may not be capable of supporting the AES mode (it probably won't work on older wireless clients). Because AES is the strongest encryption standard currently available, WPA2 with AES is highly recommended for Enterprise networks.

Any of the above encryption methods can be used and an AP can support multiple encryption methods simultaneously, but only one method may be selected per SSID (except that selecting **WPA-Both** allows WPA and WPA2 to be used at the same time on the same SSID). Otherwise, if multiple security methods are needed, you must define multiple SSIDs.

The encryption mode (WEP, WPA, etc.) is selected in the **SSIDs >SSID Management** window (see “[SSID Management](#)” on page 283). The encryption standard used with WPA or WPA2 (AES or TKIP) is selected in the **Security>Global Settings** window under **WPA Settings** (see “[Global Settings](#)” on page 255).

- **Choosing an authentication method:** User authentication ensures that users are who they say they are. For this purpose, the AP allows you to choose between the following user authentication methods:
  - **Pre-Shared Key**—users must manually enter a key (passphrase) on the client side of the wireless network that matches the key stored by the administrator in the AP.

This method should be used only for smaller networks when a RADIUS server is unavailable. If PSK must be used, choose a strong passphrase containing between 8 and 63 characters (20 is preferred). Always use a combination of letters, numbers and special characters. Never use English words separated by spaces.
  - **RADIUS 802.1x with EAP**—802.1x uses a RADIUS server to authenticate large numbers of clients, and can handle different Extensible Authentication Protocol (EAP) authentication methods, including EAP-TLS, EAP-TTLS, EAP-PEAP, and LEAP-Passthrough. The RADIUS server can be internal (provided by the Wireless AP) or external. An external RADIUS server offers more functionality and security, and is recommended for large deployments. When using this method, user names and passwords must be entered into the RADIUS server for user authentication.
  - **MAC Address Access Control Lists (ACLs)**—MAC address ACLs provide a list of client adapter MAC addresses that are allowed or denied access to the wireless network. Access Control Lists work well when there are a limited number of users—in this case, enter the MAC address of each user in the Allow list. In the event of a lost or stolen MAC adapter, enter the affected MAC

address in the Deny list. The Wireless AP will accept up to 1,000 ACL entries.

- **PCI DSS or FIPS 140-2 Security**—to implement the requirements of these security standards on the AP, please see [“Auditing PCI DSS” on page 603](#) or [“Implementing FIPS Security” on page 609](#).

### **Certificates and Connecting Securely to the WMI**

When you point your browser to the AP to connect to the WMI, the AP presents an X.509 security certificate to the browser to establish a secure channel. One significant piece of information in the certificate is the AP’s host name. This ties the certificate to a particular AP and ensures the client that it is connecting to that host.

Certificate Authorities (CAs) are entities that digitally sign certificates, using their own certificates (for example, VeriSign is a well-known CA). When the AP presents its certificate to the client’s browser, the browser looks up the CA that signed the certificate to decide whether to trust it. Browsers ship with a small set of trusted CAs already installed. If the browser trusts the certificate’s CA, it checks to ensure the host name (and IP address) match those on the certificate. If any of these checks fail, you get a security warning when connecting to the WMI.

The AP ships with a default certificate that is signed by the Riverbed CA. You may choose to use this certificate, or to use a certificate issued by the CA of your choice, as described in the following sections:

- [Using the AP’s Default Certificate](#)
- [Using an External Certificate Authority](#)

### Using the AP's Default Certificate

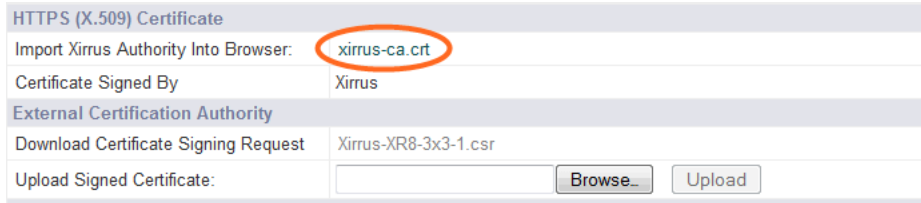

Figure 131. Import Riverbed Certificate Authority

The AP's certificate is signed by a Riverbed CA that is customized for your AP and its current host name. By default, browsers will not trust the AP's certificate. You may import the Riverbed certificate to instruct the browser to trust the Riverbed CA on all future connections to APs. The certificate for the Riverbed CA is available on the AP, so that you can import it into your browser's cache of trusted CAs (right alongside VeriSign, for example). On the [Management Control](#) window of the WMI you will see the **xirus-ca.crt** file. (Figure 131)

By clicking and opening this file, you can follow your browser's instructions and import the Riverbed CA into your CA cache (see "[HTTPS \(X.509\) Certificate](#)" on [page 250](#) for more information). This instructs your browser to trust any of the certificates signed by the Riverbed CA, so that when you connect to any of our APs you should no longer see the warning about an untrusted site. Note however, that this only works if you use the host name when connecting to the AP. If you use the IP address to connect, you get a lesser warning saying that the certificate was only meant for 'hostname'.

Since an AP's certificate is based on the AP's host name, any time you change the host name the AP's CA will regenerate and sign a new certificate. This happens automatically the next time you reboot after changing the host name. If you have already installed the Riverbed CA on a browser, this new AP certificate should automatically be trusted.

When you install the Riverbed CA in your browser, it will trust a certificate signed by any Riverbed AP, as long as you connect using the AP's host name.

## Using an External Certificate Authority

If you prefer, you may install a certificate on your AP signed by an outside CA.

The AP's certificate is used for security when stations attempt to associate to an SSID that has Web Page Redirect (captive portal) enabled. In this case, it is preferable for the AP to present a certificate from an external CA that is likely to be trusted by most browsers. When a WPR login page is presented, the user will not see a security error if the AP's certificate was obtained from an external CA that is already trusted by the user's browser.

WMI provides options for creating a Certificate Signing Request that you can send to an external CA, and for uploading the signed certificate to the AP after you obtain it from the CA. This certificate will be tied to the AP's host name and private key. See [“External Certificate Authority” on page 251](#) for more details.

## Admin Management

This window allows you to manage network administrator accounts (create, modify and delete). It also allows you to limit account access to a read only status. When finished, click the **Save** button  if you wish to make your changes permanent.

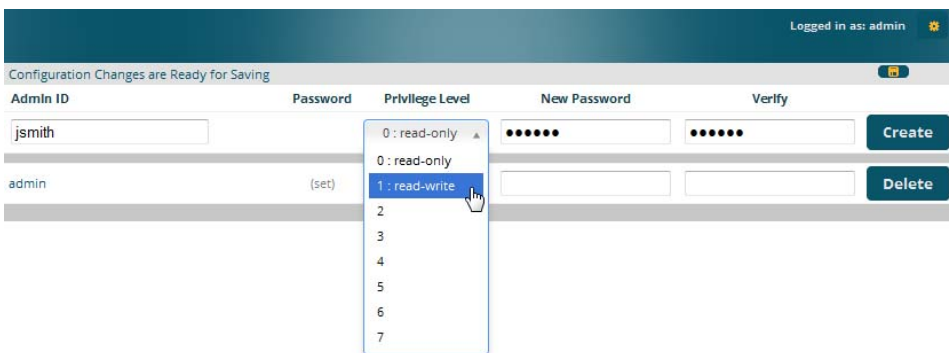



Figure 132. Admin Management



### *Procedure for Creating or Modifying Network Administrator Accounts*

1. **Admin ID:** Enter the login name for a new network administrator ID. The length of the ID must be between 5 and 50 characters, inclusive.
2. **Read/Write:** Choose **1:read-write** if you want to give this administrator ID full read/write privileges, or choose **0:read-only** to restrict this user to read only status. In the read only mode, administrators cannot save changes to configurations. Or you may select one of your custom-defined privilege levels (see “[Admin Privileges](#)” on page 238).
3. **New Password:** Enter a password for this ID. The length of the password must be between 5 and 50 characters, inclusive.
4. **Verify:** Re-enter the password in this field to verify that you typed the password correctly. If you do not re-enter the correct password, an error message is displayed).
5. Click on the **Create** button to add this administrator ID to the list.
6. Click the **Save** button  if you wish to make your changes permanent.

### *See Also*

[Admin Privileges](#)  
[External Radius](#)  
[Global Settings](#)  
[Internal Radius](#)  
[Management Control](#)

## Admin Privileges

This window provides a detailed level of control over the privileges of AP administrators. Administrators may be assigned one of eight **Privilege Levels**. You may define the privilege level of each major feature (**Configuration Section**) that may be configured on the AP. For example, say that you set the privilege level to 4 for Reboot AP, Security, Radius Server, and SNMP, and you leave all other configuration sections at the default privilege level of 1. In this case, any administrator with a privilege level of 4 or higher may perform any operation on the AP, while an administrator with a privilege level lower than 4 but at least 1 may perform any operation except those whose level was set to 4. An error message will be displayed if an operation is attempted without a sufficient privilege level.

Configuration Changes are Ready for Saving Logged in as: admin

**Privilege Level Names**

Privilege Level	Name
Level 0	read-only
Level 1	read-write
Level 2	2
Level 3	3
Level 4	4
Level 5	5
Level 6	6
Level 7	7

**Privilege Levels**

Configuration Section	Minimum Privilege Level							
	0	1	2	3	4	5	6	7
Access Control List	<input type="radio"/>	<input checked="" type="radio"/>	<input type="radio"/>	<input type="radio"/>	<input type="radio"/>	<input type="radio"/>	<input type="radio"/>	<input type="radio"/>
Administrator	<input type="radio"/>	<input checked="" type="radio"/>	<input type="radio"/>	<input type="radio"/>	<input type="radio"/>	<input type="radio"/>	<input type="radio"/>	<input type="radio"/>
Open Authentication	<input type="radio"/>	<input checked="" type="radio"/>	<input type="radio"/>	<input type="radio"/>	<input type="radio"/>	<input type="radio"/>	<input type="radio"/>	<input type="radio"/>
Boot Environment	<input type="radio"/>	<input checked="" type="radio"/>	<input type="radio"/>	<input type="radio"/>	<input type="radio"/>	<input type="radio"/>	<input type="radio"/>	<input type="radio"/>
CDP	<input type="radio"/>	<input checked="" type="radio"/>	<input type="radio"/>	<input type="radio"/>	<input type="radio"/>	<input type="radio"/>	<input type="radio"/>	<input type="radio"/>
Cluster	<input type="radio"/>	<input checked="" type="radio"/>	<input type="radio"/>	<input type="radio"/>	<input type="radio"/>	<input type="radio"/>	<input type="radio"/>	<input type="radio"/>
Console Interface	<input type="radio"/>	<input checked="" type="radio"/>	<input type="radio"/>	<input type="radio"/>	<input type="radio"/>	<input type="radio"/>	<input type="radio"/>	<input type="radio"/>
Contact Information	<input type="radio"/>	<input checked="" type="radio"/>	<input type="radio"/>	<input type="radio"/>	<input type="radio"/>	<input type="radio"/>	<input type="radio"/>	<input type="radio"/>

Figure 133. Admin Privileges

Privilege level 0 is **read-only**. As a minimum, all administrators have permission for read access to all areas of AP configuration. Higher privilege levels may be used to define additional privileges for specific configuration sections.

If you are using an [Admin RADIUS](#) server to define administrator accounts, please see “[RADIUS Vendor Specific Attribute \(VSA\) for Riverbed](#)” on page 544 to set the privilege level for each administrator.

### *Procedure for Configuring Admin Privileges*

1. **Privilege Level Names** (optional): You may assign a **Name** to each Privilege Level. The name may be used to describe the access granted by this level. By default, levels 0 and 1 are named **read-only** and **read-write**, respectively, and levels 2 through 7 have the same name as their level number.
2. **Privilege Levels**: Use this section to assign a **Minimum Privilege Level** to selected **Configuration Sections** as desired. By default, all sections are assigned level 1. When you select a higher privilege level for a configuration section, then only administrators who have at least that privilege level will be able to make configuration changes to that section.
3. You may click ^ at the bottom of any row to toggle the values in the entire column to either on or off.
4. Click the **Save** button  if you wish to make your changes permanent.

### *See Also*

[External Radius](#)

[Groups](#)

[Admin Management](#)

[Admin RADIUS](#)

[Security](#)

## Admin RADIUS

This window allows you to set up authentication of network administrators via RADIUS. Using RADIUS to control administrator accounts for logging in to APs has these benefits:

- Centralized control of administrator accounts.
- Less effort—you don't have to set up user names and passwords on each AP; just enter them once on the RADIUS server and then all of the APs can pull from the RADIUS server.
- Enforced policies—you may set password rules (e.g., passwords must contain at least one number and be at least 12 characters in length), and you may set expiration times for passwords.

Admin RADIUS settings override any local administrator accounts configured on the [Admin Management](#) window. If you have Admin RADIUS enabled, all administrator authentication is done via the configured RADIUS servers. The only exception to this is when you are connected via the Console port (using CLI). If you are using the Console port, the AP will authenticate administrators using accounts configured on the [Admin Management](#) window first, and then use the RADIUS servers. This provides a safety net to ensure that you are not completely locked out of an AP if the RADIUS server is down.

### About Creating Admin Accounts on the RADIUS Server

Permissions for RADIUS administrator accounts are controlled by the RADIUS **Riverbed-Admin-Role** attribute. This is a Vendor Specific Attribute (VSA). To define the privileges permitted to an administrator account, set the value of its Riverbed-Admin-Role attribute to the desired **Privilege Level Name** string, as defined in [“Admin Privileges” on page 238](#). For more information about the RADIUS VSAs used by Riverbed, see [“RADIUS Vendor Specific Attribute \(VSA\) for Riverbed” on page 544](#).

When configuring administrator accounts on the RADIUS server, you must observe the same restrictions for length and legal characters as when creating these accounts on the AP using the [Admin Management](#) window: the user name and password must be between 5 and 50 characters, inclusive.

Configuration Changes are Ready for Saving

Admin RADIUS Settings

Enable Admin RADIUS:  Yes  No

Authentication Type:  PAP  CHAP  MS-CHAP

Timeout (seconds):

Admin RADIUS Primary Server

Host Name / IP Address:

Port Number:

Shared Secret / Verify Secret:

Admin RADIUS Secondary Server

Host Name / IP Address:

Port Number:

Shared Secret / Verify Secret:

Figure 134. Admin RADIUS

### *Procedure for Configuring Admin RADIUS*

Use this window to enable/disable administrator authentication via RADIUS, and to set up primary and secondary servers to use for authentication of administrators attempting to log in to the AP.

#### 1. Admin RADIUS Settings:

- a. **Enable Admin RADIUS:** Click **Yes** to enable the use of RADIUS to authenticate administrators logging in to the AP. You will need to specify the RADIUS server(s) to be used.
- b. **Authentication Type:** Select the protocol used for authentication of administrators, **CHAP** or **PAP** (the default).
  - Password Authentication Protocol (PAP), is a simple protocol. PAP transmits ASCII passwords over the network “in the clear” (unencrypted) and is therefore considered insecure.
  - Challenge-Handshake Authentication Protocol (CHAP) is a more secure protocol. The login request is sent using a one-way hash function.

- 
- c. **Timeout (seconds):** Define the maximum idle time (in seconds) before the RADIUS server's session times out. The default is 600 seconds.
2. **Admin RADIUS Primary Server:** This is the RADIUS server that you intend to use as your primary server.
- a. **Host Name / IP Address:** Enter the IP address or domain name of this external RADIUS server.
  - b. **Port Number:** Enter the port number of this RADIUS server. The default is 1812.
  - c. **Shared Secret / Verify Secret:** Enter the shared secret that this RADIUS server will be using, then re-enter the shared secret to verify that you typed it correctly.



*The shared secret that you define must match the secret used by the RADIUS server.*

3. **Admin RADIUS Secondary Server** (optional): If desired, enter an alternative external RADIUS server. If the primary RADIUS server becomes unreachable, the AP will “failover” to the secondary RADIUS server (defined here).
- a. **Host Name / IP Address:** Enter the IP address or domain name of this RADIUS server.
  - b. **Port Number:** Enter the port number of this RADIUS server. The default is 1812.
  - c. **Shared Secret / Verify Secret:** Enter the shared secret that this RADIUS server will be using, then re-enter the shared secret to verify that you typed it correctly.

## Management Control

This window allows you to enable or disable the AP management interfaces and set their inactivity time-outs. The range is 300 (default) to 100,000 seconds.

The screenshot shows a web interface for configuring an AP. The 'General' section is active and contains the following settings:

- Maximum login attempts allowed (1 - 255): 3 (with an 'Unlimited' checkbox that is unchecked)
- Failed login retry period (0 - 65535 seconds): 0
- Status LED:

Below the 'General' section are several collapsed sections, each with a small upward-pointing arrow:

- Pre-Login Banner
- Post-Login Banner
- Management Transports
- Management Modes
- HTTPS (X.509) Certificate
- External Certificate Authority

Figure 135. Management Control

### *Procedure for Configuring Management Control*

#### 1. Management Settings:

- a. **Maximum login attempts allowed (1-255):** After this number of consecutive failing administrator login attempts via ssh or telnet, the **Failed login retry period** is enforced. The default is 3.
- b. **Failed login retry period (0-65535 seconds):** After the maximum number (defined above) of consecutive failing administrator login attempts via ssh or telnet, the administrator's IP address is denied access to the AP for the specified period of time (in seconds). The default is 0.
- c. **Pre-login Banner:** Text that you enter here will be displayed below the WMI login prompt. (Figure 136) Click the **Submit** button when done typing.

If you wish to display more than 256 characters of text (for instance, to display usage restrictions for the wireless network), you may

upload a text file. Click **Choose File** and browse to the file. Click **Upload** when done.

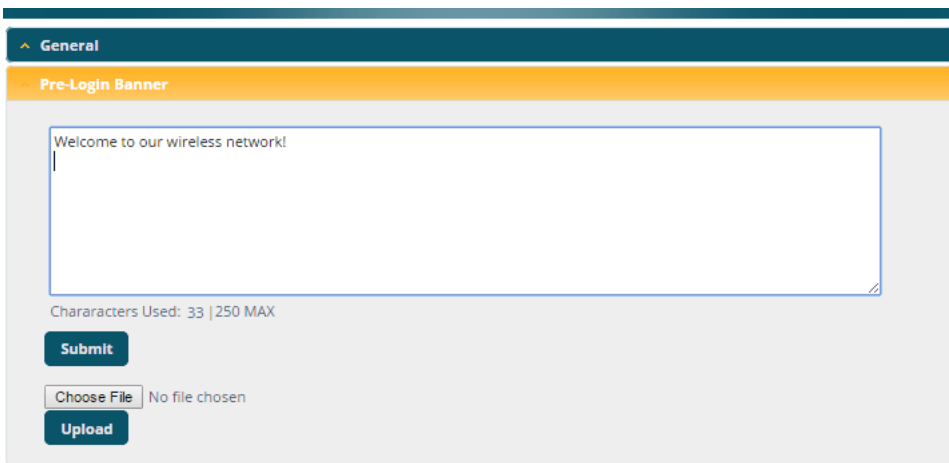

The screenshot shows a web interface for configuring a wireless access point. At the top, there is a dark blue header with the word "General" and a small upward-pointing triangle. Below this is a yellow header with the text "Pre-Login Banner". The main content area is a light gray box containing a large text input field with a blue border. The text "Welcome to our wireless network!" is entered in the field. Below the text field, it says "Characters Used: 33 | 250 MAX". There are three buttons: a dark blue "Submit" button, a "Choose File" button (which is a text input field with "No file chosen" next to it), and a dark blue "Upload" button.

Figure 136. Pre-login Banner

- d. **Post-login Banner:** Text that you enter here will be displayed in a message box after a user logs in to the WMI.

If you wish to display more than 256 characters of text, upload a text file. Click **Choose File** and browse to the file, then click **Upload**.



	Timeout (30-100000 seconds)	Port
SSH: <input checked="" type="radio"/> On <input type="radio"/> Off	100000	22
Telnet: <input type="radio"/> On <input checked="" type="radio"/> Off	300	23
Xircon: <input type="radio"/> On <input type="radio"/> Off <input checked="" type="radio"/> ArrayOS only <input type="radio"/> Boot only	300	22612
Console: <input checked="" type="radio"/> On <input type="radio"/> Off	300	
HTTPS: <input type="radio"/> On <input type="radio"/> Off	100000	443

Figure 137. Management Transports

## 2. SSH

- a. **On/Off:** Choose **On** to enable management of the AP over a Secure Shell (SSH-2) connection, or **Off** to disable this feature. Be aware that only SSH-2 connections are supported by the AP. SSH clients used for connecting to the AP must be configured to use SSH-2.
- b. **Connection Timeout 30-100000 (Seconds):** Enter a value in this field to define the timeout (in seconds) before your SSH connection is disconnected. The value you enter here must be between 30 seconds and 100,000 seconds.
- c. **Port:** Enter a value in this field to define the port used by SSH. The default port is 22.

## 3. Telnet:

- a. **On/Off:** Choose **On** to enable AP management over a Telnet connection, or **Off** to disable this feature. SSH offers a more secure connection than Telnet, and is recommended over Telnet.
- b. **Connection Timeout 30-100000 (Seconds):** Enter a value in this field to define the timeout (in seconds) before your Telnet connection is

disconnected. The value you enter here must be between 30 seconds and 100,000 seconds.

- c. **Port:** Enter a value in this field to define the port used by Telnet. The default port is 23.

#### 4. Xircon

The Xircon utility connects to Riverbed APs that do not have a physical console port, or whose console port is not accessible. Please see [“Securing Low Level Access to the AP” on page 85](#) for more information about Xircon. You can enable or disable Xircon access to the AP as instructed below.

**!** *Warning: If you disable Xircon access completely on models that have no console port, you **must** ensure that you do not lose track of the username and password to log in to CLI/WMI! There is no way to recover from a lost password, other than returning the AP to Riverbed.*

- a. **On/Off:** Choose **On** to enable Xircon access to the AP at the ArrayOS (CLI) and Riverbed Boot Loader (XBL) levels, or **Off** to disable access at both levels. Xircon access is **On** by default.
- b. **ArrayOS only:** Choose this radio button to enable Xircon access at the ArrayOS level only (i.e., Xircon can access CLI only). Access to the AP at the Riverbed Boot Loader (XBL) level is disabled.
- c. **Boot only:** Choose this radio button to enable Xircon access at the Riverbed Boot Loader (XBL) level only. ArrayOS level (CLI) access to the AP is disabled.
- d. **Connection Timeout 30-100000 (Seconds):** Enter a value in this field to define the timeout (in seconds) before your Xircon connection is disconnected. The value you enter here must be between 30 seconds and 100,000 seconds.
- e. **Port:** Enter a value in this field to define the port used by Xircon. The default port is 22612.

5. Console

- a. **On/Off:** Choose **On** to enable management of the AP via a serial connection, or choose **Off** to disable this feature.
- b. **Connection Timeout 30-100000 (Seconds):** Enter a value in this field to define the timeout (in seconds) before your serial connection is disconnected. The value you enter here must be between 30 seconds and 100,000 seconds.

6. HTTPS

- a. **Connection Timeout 30-100000 (Seconds):** Enter a value in this field to define the timeout (in seconds) before your HTTPS connection is disconnected. The value you enter here must be between 30 seconds and 100,000 seconds. Management via HTTPS (i.e., the Windows Management Interface) cannot be disabled on this window. To disable management over HTTPS, you must use the Command Line Interface.
- b. **Port:** Enter a value in this field to define the port used by HTTPS. The default port is 443.

7. Management Modes



Figure 138. Management Modes

- a. **Network Assurance:** Click the **On** button to enable this mode. Network assurance checks network connectivity to each server that you configure, such as the NTP server, RADIUS servers, SNMP trap hosts, etc. By proactively identifying network resources that are unavailable, the network manager can be alerted of problems potentially before end-users notice an issue. The distributed intelligence of APs provides this monitoring at multiple points across the network, adding to the ability to isolate the problem and expedite the resolution

Connectivity is checked when you configure a server. If a newly configured server is unreachable, you will be notified directly and a Syslog entry is created. Configured servers are checked once per **Period** which by default is 300 seconds (five minutes). Servers are checked regardless of whether they are configured as IP addresses or host names.

If a server becomes unreachable, a Syslog message is generated. When the server again becomes reachable, another Syslog message is generated.

To view the status of all configured servers checked by this feature, please see [“Network Assurance” on page 117](#).

- b. **PCI Audit Mode:** Click the **On** button to enable this mode, which is provided as an aid to setting up APs to pass PCI DSS audit requirements. In PCI Audit Mode, the AP checks whether its configuration is appropriate for auditing PCI DSS wireless security. This mode does not change any other settings, but will inform you of any incorrect settings that exist. Furthermore, the AP will monitor changes that you make to its configuration in CLI or the WMI. PCI Mode will warn you (and issue a Syslog message) if the change is inappropriate for PCI DSS. A warning is issued when a non-compliant change is first applied to the AP, and also if you attempt to save a configuration that is non-compliant. Use this command in conjunction with [“The Riverbed AP PCI Compliance Configuration” on page 605](#) to ensure that you are using the AP in accordance with

the PCI DSS requirements. For more information, see [“Auditing PCI DSS” on page 603](#).

The `pci-audit` command checks items such as:

- Telnet is disabled.
  - Admin RADIUS is enabled (admin login authentication is via RADIUS server).
  - An external Syslog server is in use.
  - All SSIDs must set encryption to WPA or better (which also enforces 802.1x authentication)
- c. **FIPS 140-2, Level 2 Security:** Please see [“Implementing FIPS Security” on page 609](#) for more information, including step-by-step instructions for proceeding to implement FIPS Level 2 Security requirements on the AP.

Click the **On** button to enable FIPS. This will perform all of the setting changes necessary to make the AP comply with FIPS requirements. A message is displayed showing the changes that were performed. The AP continues to enforce FIPS requirements by preventing you from making non-compliant configuration changes. Click the **Off** button to stop enforcing FIPS requirements.

Note that when you enable FIPS, the AP does *not* save your previous settings, and it will not restore them if you click the **Off** button. If you think you may wish to disable FIPS and restore your previous configuration at some later time, use **Set Restore Point** to save a copy of your configuration before enabling FIPS (see [Step 4 on page 419](#) in [Using Tools on the Wireless AP](#)).

- d. **Spanning Tree Protocol:** this protocol is used in Layer 2 networks to turn off ports when necessary to prevent network loops. It is **Off** by default, and is turned on automatically if you are using [WDS](#) to interconnect APs using wireless links. Use the **On** button to enable spanning tree if your network topology requires it. See [“Spanning Tree Status” on page 113](#).

## 8. HTTPS (X.509) Certificate



ArrayOS releases 6.5 and above only support 2048-bit certificates, while previous releases only support 1024-bit certificates. When ArrayOS is upgraded to 6.5 or above, a new self-signed certificate will be automatically generated.

If you have imported a previous (pre-Release 6.5 version) Riverbed CA-signed certificate into your browser, the trusted Riverbed CA needs to be updated. Delete the current Riverbed CA in the browser. Upgrade the AP to release 6.5 or above and then download the new **xirrus-ca.crt** file and import it into the browser as a trusted CA, as explained below.

If you are using a certificate signed by an external CA, its use is not impacted in any way by this change.

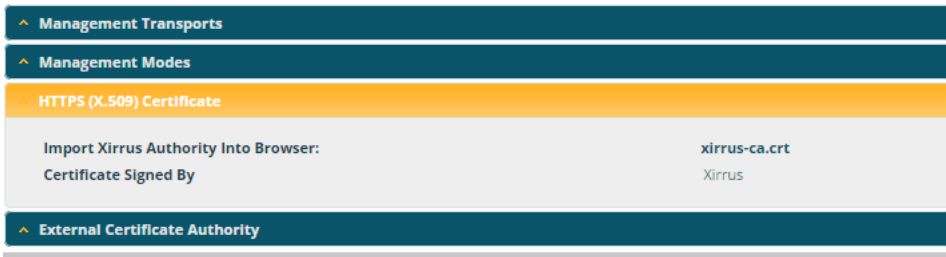

Figure 139. HTTPS (X.509) Certificate

- a. **Import Riverbed Authority into Browser:** This feature imports the Riverbed Certificate Authority (CA) into your browser (for a discussion, please see [“Certificates and Connecting Securely to the WMI” on page 234](#)). Click the link (**xirrus-ca.crt**), and then click **Open** to view or install the current Riverbed CA certificate. Click **Install Certificate** to start your browser’s Certificate Install Wizard. We recommend that you use this process to install Riverbed as a root authority in your browser.

When you assign a **Host Name** to your AP using the [Express Setup](#) window, then the next time you reboot the AP (or restart the HTTPS

service by turning it off and on again using the CLI), it automatically creates a security certificate for that host name. That certificate uses Riverbed as the signing authority. Thus, in order to avoid having certificate errors on your browser when using WMI:

- You must have assigned a host name to the AP and rebooted at some time after that.
  - Use **Import Riverbed Authority into Browser**
  - Access WMI by using the host name of the AP rather than its IP address.
- b. **HTTPS (X.509) Certificate Signed By:** This read-only field shows the signing authority for the current certificate.

### 9. External Certificate Authority

The screenshot shows a web interface for configuring an External Certificate Authority. At the top, there is a dark teal header with a caret icon and the text "HTTPS (X.509) Certificate". Below this is an orange header with the text "External Certificate Authority". The main content area is light gray and contains the following sections:

- Create a Certificate Signing Request (CSR):** This section includes several input fields: "Common Name:" with the value "XR4012802207C", "Organization Name:", "Organizational Unit Name:", "Locality (City):", "State or Province:", "Country Name (2 Letter Code):", and "Email Address:". A dark teal "Create" button is positioned below these fields.
- Download Certificate Signing Request:** This section shows the text "No CSR created for XR4012802207C.csr".
- Upload Signed Certificate:** This section features a "Choose File" button, the text "No file chosen", and a dark teal "Upload" button.

Figure 140. External Certificate Authority

This step and [Step 10](#) allow you to obtain a certificate from an external authority and install it on an AP. “[Using an External Certificate Authority](#)” on [page 236](#) discusses reasons for using an external CA.

For example, to obtain and install a certificate from VeriSign on the AP, follow these steps:

- If you don’t already have the certificate from the external (non-Riverbed) Certificate Authority, see [Step 10](#) to create a request for a certificate.
- Use option (a) to review the request and copy its text to send to VeriSign.
- When you receive the new certificate from VeriSign, upload it to the AP using option (b).

External Certification Authority has the following options:

- Download Certificate Signing Request:** After creating a certificate signing request (.csr file—[Step 10](#)), click the **View** button to review it. If it is satisfactory, click the name of the .csr file to display the text of the request. You can then copy this text and use it as required by the CA. You may also click on the filename of the .csr file to download it to your local computer.
- Upload Signed Certificate:** To use a custom certificate signed by an authority other than Riverbed, use the **Browse** button to locate the certificate file, then click **Upload** to copy it to the AP. The AP’s web server will be restarted and will pick up the new certificate. This will terminate any current web sessions, and you will need to reconnect and re-login to the AP.

## 10. To create a Certificate Signing Request

- a. Fill in the fields in this section: **Common Name**, **Organization Name**, **Organizational Unit Name**, **Locality (City)**, **State or Province**, **Country Name**, and **Email Address**. Spaces may be used in any of the fields, except for Common Name, Country Name, or Email



Address. Click the **Create** button to create the certificate signing request. See [Step 9](#) above to use this request.

11. Click the **Save** button  if you wish to make your changes permanent.

### See Also

[Interfaces](#) - to enable/disable management over an Ethernet interface

[Global Settings](#) - to enable/disable management over IAPs

[Admin Management](#)

[External Radius](#)

[Global Settings](#)

[Internal Radius](#)

[Access Control List](#)

[Security](#)

### Access Control List

This window allows you to enable or disable the use of the global Access Control List (ACL), which controls whether a station with a particular MAC address may associate to the AP. You may create station access control list entries and delete existing entries, and control the type of list.

There is only one global ACL, and you may select whether its type is an Allow List or a Deny List, or whether use of the list is disabled.

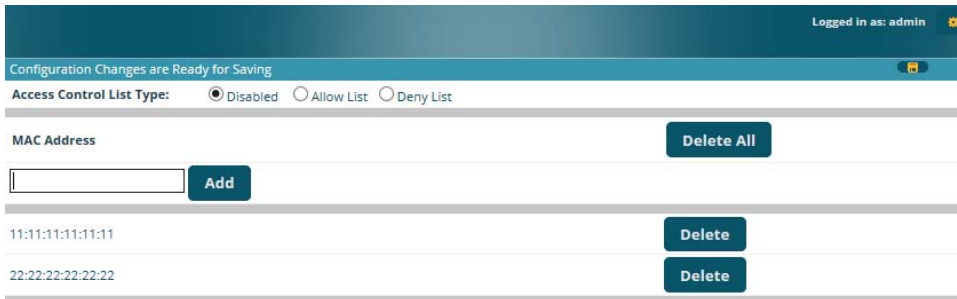

Logged in as: admin

Configuration Changes are Ready for Saving

Access Control List Type:  Disabled  Allow List  Deny List

MAC Address	
	Delete All
<input type="text"/>	Add
11:11:11:11:11:11	Delete
22:22:22:22:22:22	Delete

Figure 141. Access Control List

There is also a per-SSID ACL (see “[Per-SSID Access Control List](#)” on page 305). If the same MAC address is listed in both the global ACL and in an SSID’s ACL, and if either ACL would deny that station access to that SSID, then access will be denied.

### *Procedure for Configuring Access Control Lists*

1. **Access Control List Type:** Select **Disabled** to disable use of the Access Control List, or select the ACL type—either **Allow List** or **Deny List**.
  - **Allow List:** Only allows the listed MAC addresses to associate to the AP. All others are denied.
  - **Deny List:** Denies the listed MAC addresses permission to associate to the AP. All others are allowed.



*In addition to these lists, other authentication methods (for example, RADIUS) are still enforced for users.*

2. **MAC Address:** If you want to add a MAC address to the ACL, enter the new MAC address here, then click on the **Add** button. The MAC address is added to the ACL. You may use a wildcard (\*) for one or more digits to match a range of addresses. You may create up to 1000 entries.
3. **Delete:** You can delete selected MAC addresses from this list by clicking their **Delete** buttons.
4. Click the **Save** button  if you wish to make your changes permanent.

### *See Also*

[External Radius](#)

[Global Settings](#)

[Internal Radius](#)

[Management Control](#)

[Security](#)

[Station Status Windows](#) (list of stations that have been detected by the AP)

### Global Settings

This window allows you to establish the security parameters for your wireless network, including WEP, WPA, WPA2 and RADIUS authentication. When finished, click the **Save** button  if you wish to make your changes permanent.

For additional information about wireless network security, refer to “Security Planning” on page 60 and “Understanding Security” on page 231.

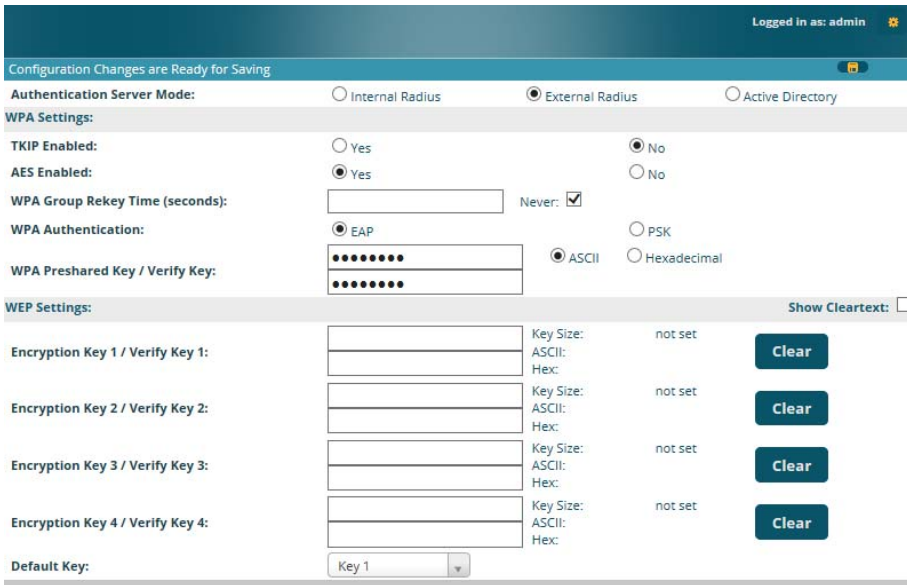

Configuration Changes are Ready for Saving

Logged in as: admin

Authentication Server Mode:  Internal Radius  External Radius  Active Directory

WPA Settings:

TKIP Enabled:  Yes  No

AES Enabled:  Yes  No

WPA Group Rekey Time (seconds):  Never:

WPA Authentication:  EAP  PSK

WPA Preshared Key / Verify Key:   ASCII  Hexadecimal

WEP Settings:  Show Cleartext:

Encryption Key 1 / Verify Key 1:	<input type="text"/>	Key Size: not set ASCII: Hex:	<input type="button" value="Clear"/>
Encryption Key 2 / Verify Key 2:	<input type="text"/>	Key Size: not set ASCII: Hex:	<input type="button" value="Clear"/>
Encryption Key 3 / Verify Key 3:	<input type="text"/>	Key Size: not set ASCII: Hex:	<input type="button" value="Clear"/>
Encryption Key 4 / Verify Key 4:	<input type="text"/>	Key Size: not set ASCII: Hex:	<input type="button" value="Clear"/>

Default Key:

Figure 142. Global Settings (Security)

#### Procedure for Configuring Network Security

1. **Authentication Server Mode:** Choose the type of Authentication Server that you will use for authenticating wireless users:
  - **Internal RADIUS** defines wireless user accounts locally on the AP. See “Internal Radius” on page 264.
  - **External RADIUS** defines wireless user accounts on a RADIUS server external to the AP. See “External Radius” on page 259.

- **Active Directory** defines wireless user accounts on an Active Directory server external to the AP. See “Active Directory” on page 266.

### WPA Settings

These settings are used if the **WPA** or **WPA2** encryption type is selected on the **SSIDs > SSID Management** window or the **Express Setup** window (on this window, encryption type is set in the **SSID Settings: Wireless Security** field).

2. **TKIP Enabled:** Choose **Yes** to enable **TKIP** (Temporal Key Integrity Protocol), or choose **No** to disable TKIP.



*TKIP encryption does not support high throughput rates for 802.11n, per the IEEE 802.11n specification.*

*TKIP should never be used for WDS links on APs.*

3. **AES Enabled:** Choose **Yes** to enable **AES** (Advanced Encryption Standard), or choose **No** to disable AES. If both AES and TKIP are enabled, the station determines which will be used.
4. **WPA Group Rekey Time (seconds):** Enter a value to specify the group rekey time (in seconds). The default is **Never**.
5. **WPA Preshared Key / Verify Key:** If you enabled PSK, enter a passphrase here, then re-enter the passphrase to verify that you typed it correctly.

### WEP Settings

These settings are used if the **WEP** encryption type is selected on the **SSIDs > SSID Management** window or the **Express Setup** window (on this window, encryption type is set in the **SSID Settings: Wireless Security** field).

Click the **Show Cleartext** button to make the text that you type in to the Key fields visible.



*WEP encryption does not support high throughput rates or features like frame aggregation or block acknowledgments for 802.11n, per the IEEE 802.11n specification.*

*WEP should never be used for WDS links on APs.*

#### 6. Encryption Key 1 / Verify Key 1:

**Key Size:** Key length is automatically computed based on the Encryption Key that you enter

- 5 ASCII characters (10 hex) for 40 bits (WEP-64)
- 13 ASCII characters for (26 hex) 104 bits (WEP-128)

**Encryption Key 1 / Verify Key 1:** Enter an encryption key in ASCII or hexadecimal. The ASCII and translated hexadecimal values will appear to the right if you selected the **Show Cleartext** button.

Re-enter the key to verify that you typed it correctly. You may include special ASCII characters, except for the double quote symbol (“).

7. **Encryption Key 2 to 4/ Verify Key 2 to 4/ Key Mode/Length** (optional): If desired, enter up to four encryption keys, in the same way that you entered the first key.
8. **Default Key:** Choose which key you want to assign as the default key. Make your selection from the pull-down list.
9. Click the **Save** button  if you wish to make your changes permanent.



*After configuring network security, the configuration must be applied to an SSID for the new functionality to take effect.*

*See Also*

Admin Management  
External Radius  
Internal Radius  
Access Control List  
Management Control  
Security  
Security Planning  
SSID Management

## External Radius

This window allows you to define the parameters of an external RADIUS server for user authentication. To set up an external RADIUS server, you must choose **External Radius** as the **Authentication Server Mode** in “Global Settings” on page 255.

<b>Primary Server</b>	
Host Name / IP Address:	RADIUS1
Port Number:	1812
Shared Secret / Verify Secret:	.....
<b>Secondary Server</b>	
Host Name / IP Address:	RADIUS2
Port Number:	1812
Shared Secret / Verify Secret:	.....
<b>Radius Fallover Settings</b>	
Timeout (seconds):	600
Fallover Timeout (seconds):	10
<b>RADIUS Dynamic Authorization Settings</b>	
DAS Port:	3799
DAS Event-Timestamp:	<input checked="" type="radio"/> Optional <input type="radio"/> Required
DAS Time Window:	300
NAS Identifier:	
<b>RADIUS Attribute Formatting</b>	
Called-Station-Id Attribute Format:	<input type="radio"/> BSSID <input checked="" type="radio"/> BSSID:SSID <input type="radio"/> Ethernet-MAC <input checked="" type="radio"/> lower-case [xxxxxxxxxxxx]
Station MAC Format:	<input type="radio"/> UPPER-case [xxxxxxxxxxxx] <input type="radio"/> lc-hyphenated [xx-xx-xx-xx-xx-xx] <input type="radio"/> UC-hyphenated [XX-XX-XX-XX-XX-XX]
Accounting:	<input checked="" type="radio"/> Off <input type="radio"/> On
<b>Accounting</b>	
Accounting Interval (seconds):	300
Primary Server Host Name / IP Address:	RADIUS1
Primary Server Port Number:	1813
Primary Server Shared Secret / Verify Secret:	.....
Secondary Server Host Name / IP Address:	RADIUS2
Secondary Server Port Number:	1813

Figure 143. External RADIUS Server

If you want to include user group membership in the RADIUS account information for users, see “Understanding Groups” on page 310. User groups allow you to easily apply a uniform configuration to a user on the AP.

### About Creating User Accounts on the RADIUS Server

An attribute of user (wireless client) accounts is controlled by RADIUS Vendor Specific Attributes (VSAs) defined by Riverbed. In particular, use the VSA named **Riverbed-Admin-Role** to set the privilege level for an account. For more information about the RADIUS VSAs used by Riverbed, see [“RADIUS Vendor Specific Attribute \(VSA\) for Riverbed” on page 544](#).

### Procedure for Configuring an External RADIUS Server

1. **Primary Server:** This is the external RADIUS server that you intend to use as your primary server.
  - a. **Host Name / IP Address:** Enter the IP address or domain name of this external RADIUS server.
  - b. **Port Number:** Enter the port number of this external RADIUS server. The default is 1812.
  - c. **Shared Secret / Verify Secret:** Enter the shared secret that this external RADIUS server will be using, then re-enter the shared secret to verify that you typed it correctly.



*The shared secret that you define must match the secret used by the external RADIUS server.*

2. **Secondary Server** (optional): If desired, enter an alternative external RADIUS server. If the primary RADIUS server becomes unreachable, the AP will “failover” to the secondary RADIUS server (defined here).
  - a. **Host Name / IP Address:** Enter the IP address or domain name of this external RADIUS server.
  - b. **Port Number:** Enter the port number of this external RADIUS server. The default is 1812.
  - c. **Shared Secret / Verify Secret:** Enter the shared secret that this external RADIUS server will be using, then re-enter the shared secret to verify that you typed it correctly.



**3. Radius Failover Settings:**

- a. Timeout (seconds):** Define the maximum time before the RADIUS server is retried after a failure. The default is 600 seconds. Note that this timeout applies to the primary and secondary servers, and is unrelated to Radius Dynamic Authorization—RFC 5176.
- b. Failover Timeout (seconds):** This limits the amount of time that the AP will continue to try RADIUS authentication requests to a server before switching to another server. This is especially useful for some devices such as iPads that only make a few authentication requests before they stop trying an SSID. The default is 10 seconds, with a configurable range of 10 to 600 seconds. The Failover Timeout is available globally and per SSID. Note that this timeout applies to the primary and secondary servers, and is unrelated to Radius Dynamic Authorization—RFC 5176.

**4. Settings (RADIUS Dynamic Authorization):** Some RADIUS servers have the ability to contact the AP (referred to as an NAS, see below) to terminate a user with a Disconnect Message (DM). Or RADIUS may send a Change-of-Authorization (CoA) Message to the AP to change a user's privileges due to changing session authorizations. This implements [RFC 5176—Dynamic Authorization Extensions to RADIUS](#).

- a. DAS Port:** RADIUS will use the DAS port on the AP for Dynamic Authorization Extensions to RADIUS. The default port is **3799**.
- b. DAS Event-Timestamp:** The Event-Timestamp Attribute provides a form of protection against replay attacks. If you select **Required**, both the RADIUS server and the AP will use the Event-Timestamp Attribute and check that it is current within the **DAS Time Window**. If the Event-Timestamp is not current, then the DM or CoA Message will be silently discarded.
- c. DAS Time Window:** This is the time window used with the **DAS Event-Timestamp**, above.
- d. NAS Identifier:** From the point of view of a RADIUS server, the AP is a client, also called a Network Access Server (NAS). Enter the NAS

Identifier (IP address) that the RADIUS servers expect the AP to use—normally the IP address of the AP's Gigabit1 port.

5. **RADIUS Attribute Formatting Settings:** Some RADIUS servers, especially older versions, expect information to be sent to them in a legacy format. These settings are provided for the unusual situation that requires special formatting of specific types of information sent to the RADIUS server. Most users will not need to change these settings.
  - a. **Called-Station-Id Attribute Format:** Define the format of the **Called-Station-Id** RADIUS attribute sent from the AP—**BSSID:SSID** (default) or **BSSID**. This identifies the AP that is attempting to authenticate a client. **BSSID** is the MAC address of the IAP receiving the client signal. The **BSSID:SSID** option additionally identifies the SSID to which the client wishes to connect. If your site is using Purple WiFi, you must use **Ethernet-MAC**, which identifies the AP using its wired network MAC address rather than a particular IAP. See [“Web Page Redirect for Purple WiFi Venues” on page 300](#).
  - b. **Station MAC Format:** Define the format of the **Station MAC** RADIUS attribute sent from the AP—lower-case or upper-case, hyphenated or not. The default is lower-case, not hyphenated.
6. **Accounting Settings:**

Note that RADIUS accounting start packets sent by the AP will include the client station's Framed-IP-Address attribute.

The RADIUS attribute Type-50 Acct-Multi-Session-Id is included in all RADIUS accounting messages generated by ArrayOS. This attribute is used, for example, by Aruba ClearPass to facilitate functions such as onboarding and guest access when stations are roaming between APs.

- a. **Accounting Interval (seconds):** Specify how often Interim records are to be sent to the server. The default is 300 seconds.
- b. **Primary Server Host Name / IP Address:** Enter the IP address or domain name of the primary RADIUS accounting server that you intend to use.

- c. **Primary Port Number:** Enter the port number of the primary RADIUS accounting server. The default is 1813.
  - d. **Primary Shared Secret / Verify Secret:** Enter the shared secret that the primary RADIUS accounting server will be using, then re-enter the shared secret to verify that you typed it correctly.
  - e. **Secondary Server Host Name / IP Address** (optional): If desired, enter an IP address or domain name for an alternative RADIUS accounting server. If the primary server becomes unreachable, the AP will “failover” to this secondary server (defined here).
  - f. **Secondary Port Number:** If using a secondary accounting server, enter its port number. The default is 1813.
  - g. **Secondary Shared Secret / Verify Secret:** If using a secondary accounting server, enter the shared secret that it will be using, then re-enter the shared secret to verify that you typed it correctly.
7. Click the **Save** button  if you wish to make your changes permanent.

### *See Also*

[Admin Management](#)

[Global Settings](#)

[Internal Radius](#)

[Access Control List](#)

[Management Control](#)

[Security](#)

[Understanding Groups](#)

## Internal Radius

This window allows you to define the parameters for the AP's internal RADIUS server for user authentication. However, the internal RADIUS server will only authenticate wireless clients that want to associate to the AP. This can be useful if an external RADIUS server is not available. To set up the internal RADIUS server, you must choose **Internal Radius** as the **Authentication Server Mode** in “Global Settings” on page 255.

Configuration Changes are Ready for Saving

Logged in as: admin

Delete All

User Name	SSID Restriction	User Group	Password / Verify	
<input type="text"/>	Select SSID...	Select Group...	<input type="text"/>	Create
AlfredENEuman	xyzcorp	Select Group...	<input type="text"/>	Delete
BuffySummers	xyzcorp	Select Group...	<input type="text"/>	Delete
JohnMcClaine	xyzcorp	Select Group...	<input type="text"/>	Delete

Figure 144. Internal RADIUS Server



*Clients using PEAP may have difficulty authenticating to the AP using the Internal RADIUS server due to invalid security certificate errors. To prevent this problem, the user may disable the **Validate Server Certificate** option on the station. Do this by displaying the station's wireless devices and then displaying the properties of the desired wireless interface. In the security properties, disable **Validate server certificate**. In some systems, this may be found by setting the authentication method to PEAP and changing the associated settings.*

### *Procedure for Creating a New User*

1. **User Name:** Enter the name of the user that you want to authenticate to the internal RADIUS server. You may enter up to 1000 users (up to 256 on the XR-500 Series, or up to 480 on two-radio APs).
2. **SSID Restriction:** (Optional) If you want to restrict this user to associating to a particular SSID, choose an SSID from the pull-down list.
3. **User Group:** (Optional) If you want to make this user a member of a previously defined user group, choose a group from the pull-down list. This will apply all of the user group's settings to the user. See [“Understanding Groups” on page 310](#).
4. **Password:** (Optional) Enter a password for the user.
5. **Verify:** (Optional) Retype the user password to verify that you typed it correctly.
6. Click on the **Create** button to add the new user to the list.

### *Procedure for Managing Existing Users*

1. **SSID Restriction:** (Optional) If you want to restrict a user to associating to a particular SSID, choose an SSID from its pull-down list.
2. **User Group:** (Optional) If you want to change the user's group, choose a group from the pull-down list. This will apply all of the user group's settings to the user. See [“Understanding Groups” on page 310](#).
3. **Password:** (Optional) Enter a new password for the selected user.
4. **Verify Password:** (Optional) Retype the user password to verify that you typed it correctly.
5. If you want to delete one or more users, click their **Delete** buttons.
6. Click the **Save** button  if you wish to make your changes permanent.

### *See Also*

[Admin Management](#)

[External Radius](#)

[Global Settings](#)

Access Control List  
Management Control  
Security  
Understanding Groups

## Active Directory



*XR-520/XR-1000 Series APs do not support Active Directory. You will receive an error message if you attempt to configure this feature.*

This window allows you to configure 802.1x user authentication without needing to set up and use an [External Radius](#) server. The AP performs authentication by utilizing an Active Directory server that you have deployed within your network domain.

This window configures the settings required to connect to the Active Directory server. Additionally, [Active Directory Test Tools](#) are provided to ease the process of validating proper communication between the Active Directory server and the AP.

To use the Active Directory settings on this page you must choose **Active Directory** as the **Authentication Server Mode** in “[Global Settings](#)” on page 255.

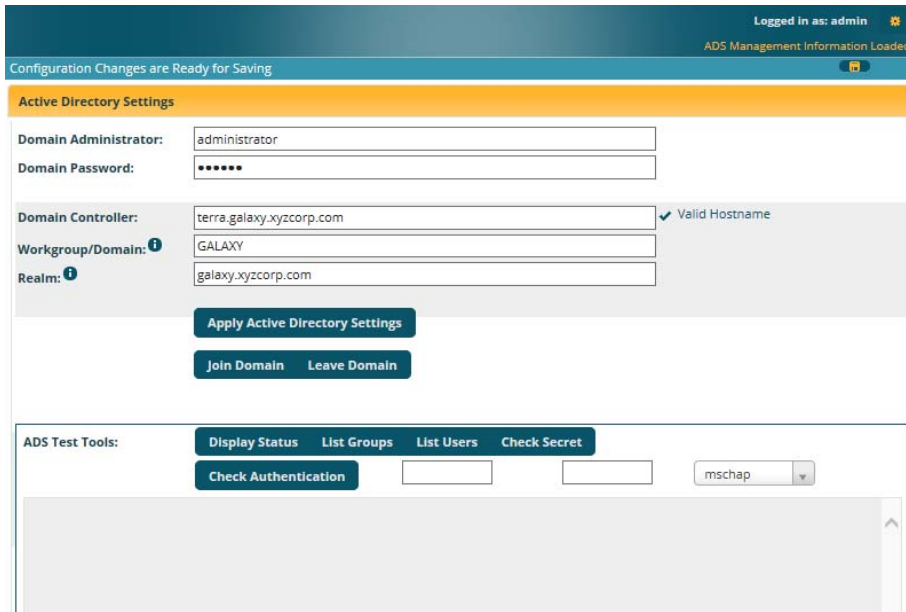

Figure 145. Active Directory Server

*Procedure for Use of an Active Directory Server*

1. Choose **Active Directory** as the **Authentication Server Mode** in “[Global Settings](#)” on page 255.
2. **Domain Administrator:** Enter the administrator account name for access to the domain controller. The AP will use this (together with the password) to create a machine account on the domain for the AP. This can be the name of any account that can join a machine to the domain.
3. **Domain Password:** The password for the **Domain Administrator** entered above.
4. **Domain Controller:** Enter the hostname to access the domain controller. This must be a fully qualified domain name (FQDN). This cannot be entered as an IP address. The AP will check that it is able to access the controller and place a checkmark to the right of the entry to indicate that it has been validated. Note that the checkmark only appears after you

have made a change requiring validation (i.e., entering a new hostname or changing an existing entry to a different hostname). If you return to this page at a later time, the checkmark will not be present.

5. **Workgroup/Domain:** Enter the Pre-Windows 2000 Domain name. This can be found by opening the Active Directory **Users and Computers**. Right click the domain in the left hand window and select **Properties**. This will display the **Domain name** that should be entered.

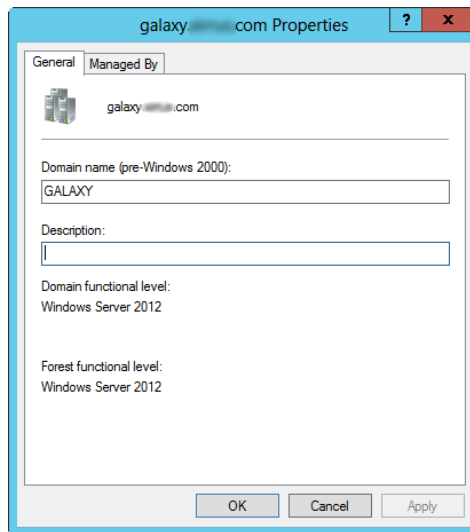

Figure 146. Finding the Domain Name from Active Directory

6. **Realm:** Realm name (may be the same as the domain name). **Workgroup** and **Realm** are both required. To find the Realm, open a command window on a domain workstation and type

```
echo %userdnsdomain%
```

This will display the Realm.

7. Click **Apply Active Directory Settings** to use these settings.
8. You must click **Join Domain** to ask the domain controller to join the AP to the domain. The AP is added to the list of computers in the workgroup. The status of the request will be displayed in the area below the Test



Tools. The domain controller will give the AP a secret that may be used as a key to fetch information. The secret may be checked with the **Check Secret** test tool, below. You may click **Leave Domain** to ask the domain controller to remove the AP from the domain and revoke its secret.

9. You may use the tools below to check that the AP is able to access and use the Active Directory successfully, or to troubleshoot any problems.

### *Active Directory Test Tools*

10. **Display Status:** Displays detailed status information for the Active Directory.
11. **List Groups:** Shows the groups defined in the Active Directory for this **Workgroup**.
12. **List Users:** Shows the users defined in the Active Directory for this **Workgroup**.
13. **Check Secret:** The continued validity of the secret granted by **Join Domain** may be checked with this test tool.
14. **Check Authentication:** Enter a **User** name and **Password**. Select the **Type** of encryption to be used (**MSCHAP**, **NTLM**, **PAP**, or **PEAP-MSCHAPv2**), to check that it will work with the Active Directory server. Then click **Check Authentication** to validate that the AP can authenticate the user with the selected type of encryption.

### *See Also*

[Admin Management](#)

[External Radius](#)

[Internal Radius](#)

[Security](#)

[Understanding Groups](#)

## Rogue Control List

This window allows you to set up a control list for rogue APs, based on a type that you define. You may classify rogue APs as blocked, so that the AP will take steps to prevent stations from associating with the blocked AP. See [“About Blocking Rogue APs”](#) on page 381. The AP can keep up to 5000 list entries.



*The **RF Monitor > Intrusion Detection** window provides an alternate method for classifying rogues. You can list all Unknown stations and select all the rogues that you'd like to set to Known or Approved, rather than entering the SSID/BSSID as described below. See [“Rogues”](#) on page 124.*

Rogue BSSID/SSID	Blocked	Approved	Known	Match Only:	BSSID	SSID	Manufacturer	
<input type="text"/>	<input type="radio"/>	<input type="radio"/>	<input checked="" type="radio"/>		<input checked="" type="radio"/>	<input type="radio"/>	<input type="radio"/>	Create
64:a7:dd:*	<input type="radio"/>	<input type="radio"/>	<input checked="" type="radio"/>		<input checked="" type="radio"/>	<input type="radio"/>	<input type="radio"/>	Delete

Figure 147. Rogue Control List

### Procedure for Establishing Rogue AP Control

1. **Rogue BSSID/SSID:** Enter the BSSID, SSID, or manufacturer string to match for the new rogue control entry. The **Match Only** radio buttons specify what to match (e.g., the MAC address, SSID, or manufacturer).

You may use the “\*” character as a wildcard to match any string at this position. For example, 00:0f:7d:\* matches any string that starts with 00:0f:7d:. Riverbed APs start with 00:0f:7d: or 50:60:28:00:0f:7d:\*. By default, the Rogue Control List contains two entries that match **00:0f:7d:\*** and **50:60:28:\*** and apply the classification **Known** to all Riverbed APs.

2. **Rogue Control Classification:** Enter the classification for the specified rogue AP(s), either **Blocked**, **Known** or **Approved**.

3. **Match Only:** Select the match criterion to compare the **Rogue BSSID/SSID** string against: **BSSID**, **Manufacturer**, or **SSID**. The BSSID field contains the MAC address.
4. Click **Create** to add this rogue AP to the Rogue Control List.
5. **Rogue Control List:** If you want to edit the control type for a rogue AP, just click the radio button for the new type for the entry: **Blocked**, **Known** or **Approved**.
6. To delete rogue APs from the list, click their **Delete** buttons.
7. Click the **Save** button  if you wish to make your changes permanent.

### *See Also*

[Network Map](#)

[Rogues](#)

[SSIDs](#)

[SSID Management](#)

### **OAuth 2.0 Management**

This window displays a list of tokens granted by the AP for access to its RESTful API (see [“API Documentation” on page 429](#) for a description of the features available in the API). OAuth 2.0 is used to provide the tokens. The list will be blank until tokens have been issued as described below. You may revoke (delete) existing tokens from the list, if desired.

Riverbed APs use the OAuth 2.0 standard’s client credential grant model. This allows you to use administrator account credentials to obtain a token to access RESTful API on an individual AP. Please note that the AP will issue only **one** token on behalf on of any administrator account at any given time. If you have a need for multiple tokens, then the AP will need multiple administrator accounts.

Follow the steps below to obtain a token and use the RESTful API.

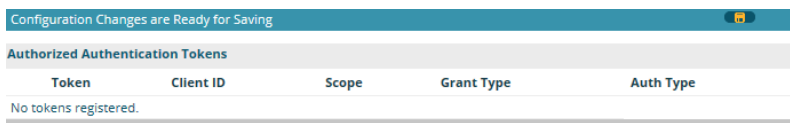

Authorized Authentication Tokens				
Token	Client ID	Scope	Grant Type	Auth Type
No tokens registered.				

Figure 148. OAuth 2.0 Management - Token List

### *Procedure for Obtaining a Token and Accessing RESTful API on the AP*

#### 1. Present User Credentials for a Permanent Token

A user-developed application must register by presenting the following information to the URL below:

```
https://[AP hostname or IP address]/oauth/authorize
```

- **grant\_type:** password
- **username:** username of an administrator account on the AP.
- **client\_id:** username of an administrator account on the AP (username and client\_id must match).
- **password:** password for the same administrator account on the AP

The OAuth Authorization API provides a permanent token that the application may use to access the RESTful API. This token remains valid until the administrator revokes the token on the **OAuth 2.0 Management** page, unless the token file somehow becomes corrupted or is removed from the AP's file system.

The token will be removed if the original account associated with it is deleted.

#### 2. Access the RESTful API

Once registration is completed and a permanent token has been provided, your application may access the API using the **client\_id** and the token at the following URL:

```
https://[AP hostname or IP address]/api/v3/[api-name]
```

Please see [“API Documentation”](#) on [page 429](#) for a description of the features available in the API.

## SSIDs

This status-only window allows you to review **SSID** (Service Set Identifier) assignments. It includes the SSID name, whether or not an SSID is visible on the network, any security and **QoS** parameters defined for each SSID, associated **VLAN** IDs, radio availability, and DHCP pools defined per SSID. Click on an SSID's name to jump to the edit page for the SSID. There are no configuration options available on this page, but if you are experiencing problems or reviewing SSID management parameters, you may want to print this page for your records.

Configuration Changes are Ready for Saving														
SSIDs														
SSID	Authenticati	Encryption	Security Settings	VLAN	VLAN Num	QC	Band	Avaya Roaming	Broadca	DHCP Pool	WPI	ACL	Fall	Mobile
xyzcorp	802-1x	wpa-both	unique-settings	none	0	2	Both	layer 2-only	on		off	off	off	none
Limits														
SSID	Enabled	Active	Station Limit	SSID	Stations	SSID	Stations	Time On	Time Off	Days On				
xyzcorp	yes	yes	unlimited	unlimited	unlimited	unlimited	unlimited	always	never	All				
WPR Whitelists						Access Control Lists								
SSID	Name					SSID	MAC							
Honeypot Whitelists						Honeypot Broadcast SSIDs								
Whitelist Name						Broadcast SSID								

Figure 149. SSIDs

The read-only **Limits** section of the SSIDs window allows you to review any limitations associated with your defined SSIDs. For example, this window shows the current state of an SSID (enabled or not), how much SSID and station traffic is allowed, time on and time off, days on and off, and whether each SSID is currently active or inactive.

For information to help you understand SSIDs and how multiple SSIDs are managed by the Wireless AP, go to [“Understanding SSIDs” on page 275](#) and the [Multiple SSIDs](#) section of [“Frequently Asked Questions” on page 532](#). For a description of how QoS operates on the AP, see [“Understanding QoS Priority on the Wireless AP” on page 277](#).

SSIDs are managed with the following windows:

- [“SSID Management” on page 283](#)
- [“Active IAPs” on page 304](#)
- [“Per-SSID Access Control List” on page 305](#)
- [“Honeypots” on page 306](#)
- [“Personal Wi-Fi” on page 308](#)

SSIDs are discussed in the following topics:

- [“Understanding SSIDs” on page 275](#)
- [“Understanding QoS Priority on the Wireless AP” on page 277](#)
- [“High Density 2.4G Enhancement—Honeypot SSID” on page 281](#)

### **Understanding SSIDs**

The SSID (Service Set Identifier) is a unique identifier that wireless networking devices use to establish and maintain wireless connectivity. Multiple access points on a network or sub-network can use the same SSIDs. SSIDs are case-sensitive and can contain up to 32 alphanumeric characters (do not include spaces when defining SSIDs).

#### ***Multiple SSIDs***

A BSSID (Basic SSID) refers to an individual access point radio and its associated clients. The identifier is the MAC address of the access point radio that forms the BSS. A group of BSSs can be formed to allow stations in one BSS to communicate to stations in another BSS via a backbone that interconnects each access point.

The Extended Service Set (ESS) refers to the group of BSSIDs that are grouped together to form one ESS. The ESSID (often referred to as SSID or “wireless network name”) identifies the Extended Service Set. Clients must associate to a

single ESS at any given time. Clients ignore traffic from other Extended Service Sets that do not have the same SSID.

Legacy access points typically support one SSID per access point. Wireless APs support the ability to define and use multiple SSIDs simultaneously.

### *Using SSIDs*

The creation of different wireless network names allows system administrators to separate types of users with different requirements. The following policies can be tied to an SSID:

- The wireless security mode needed to join this SSID.
- The wireless Quality of Service (QoS) desired for this SSID.
- The wired VLAN associated with this SSID.

As an example, one SSID named **accounting** might require the highest level of security, while another named **guests** might have low security requirements.

Another example may define an SSID named **voice** that supports voice over Wireless LAN phones with the highest Quality of Service (QoS) definition. This SSID might also forward traffic to specific VLANs on the wired network.

### *See Also*

[SSID Management](#)

[SSIDs](#)

[Understanding SSIDs](#)



### Understanding QoS Priority on the Wireless AP

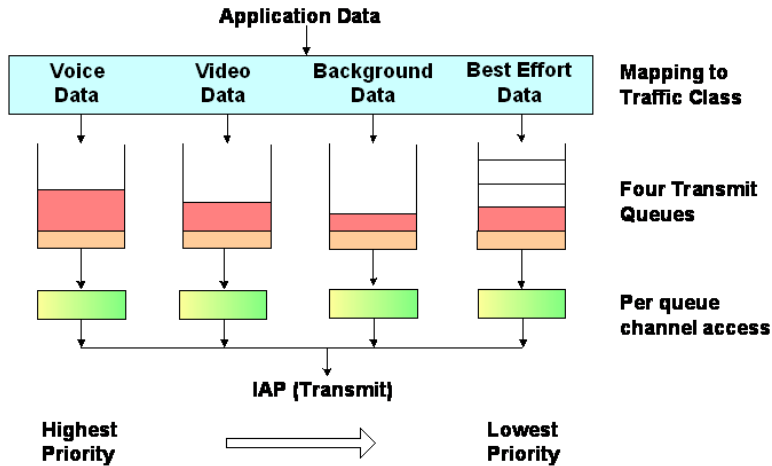

Figure 150. Four Traffic Classes

The Wireless AP's Quality of Service Priority feature (QoS) allows traffic to be prioritized according to your requirements. For example, you typically assign the highest priority to voice traffic, since this type of traffic requires delay to be under 10 ms. The AP has four separate queues for handling wireless traffic at different priorities, and thus it supports four traffic classes (QoS levels).

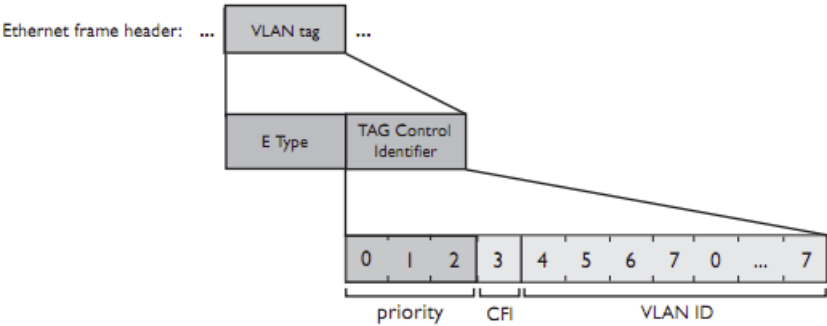

Figure 151. Priority Level—IEEE 802.1p (Layer 2)

IEEE802.1p uses three bits in an Ethernet frame header to define eight priority levels at the MAC level (Layer 2) for wired networks. Each data packet may be tagged with a priority level, i.e., a **user priority** tag. Since there are eight possible user priority levels and the AP implements four wireless QoS levels, user priorities are mapped to QoS as described below.

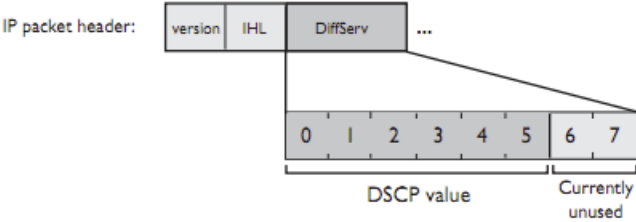

Figure 152. Priority Level—DSCP (DiffServ - Layer 3)

Differentiated Services Code Point or DiffServ (DSCP) uses 6 bits in the IPv4 or IPv6 packet header, defined in [RFC2474](#) and [RFC2475](#). The DSCP value classifies a Layer 3 packet to determine the Quality of Service (QoS) required. DSCP replaces the outdated Type of Service (TOS) field.

The description below describes how both of these priority levels are mapped to the AP’s four traffic classes.

**End-to-End QoS Handling**

Wired QoS - Ethernet Port:

- Egress: Outgoing wired packets are IEEE 802.1p tagged at the Ethernet port for upstream traffic, thus enabling QoS at the edge of the network.

FROM AP QoS (Wireless)	TO Priority Tag 802.1p (Wired)
1 (Lowest priority)	1
0	0
2 (Default)	5
3 (Highest priority)	6

- Ingress: Incoming wired packets are assigned QoS priority based on their SSID and 802.1p tag (if any), as shown in the table below. This table follows the mapping recommended by IEEE802.11e.

FROM Priority Tag 802.1p (Wired)	TO AP QoS (Wireless)	Typical Use
0	0	Best Effort
1	1 (Lowest priority)	Background—explicitly designated as low-priority and non-delay sensitive
2	1	Spare
3	0	Excellent Effort
4	2	Controlled Load
5	2	Video
6	3	Voice - requires delay <10ms
7 (Highest priority)	3 (Highest priority)	Network control

---

### Wireless QoS - Radios:

- Each SSID can be assigned a separate QoS priority (i.e., traffic class) from 0 to 3, where 3 is highest priority and 2 is the default. See [“SSID Management” on page 283](#). If multiple SSIDs are used, packets from the SSID with higher priority are transmitted first.
- The AP supports IEEE802.11e Wireless QoS for downstream traffic. Higher priority packets wait a shorter time before gaining access to the air and contend less with all other 802.11 devices on a channel.
- How QoS is set for a packet in case of conflicting values:
  - a. If an SSID has a QoS setting, and an incoming wired packet’s user priority tag is mapped to a higher QoS value, then the higher QoS value is used.
  - b. If a group or filter has a QoS setting, this overrides the QoS value above. See [“Groups” on page 310](#), and [“Filters” on page 398](#).
  - c. Voice packets have the highest priority (see [Voice Support](#), below).
  - d. If **DSCP to QoS Mapping Mode** is enabled, the IP packet is mapped to QoS level 0 to 3 as specified in the [DSCP Mappings](#) table. This value overrides any of the settings in cases a to c above.

In particular, by default:

- DSCP 8 is set to QoS level 1.
- DSCP 40 is typically used for video traffic and is set to QoS level 2.
- DSCP 48 is typically used for voice traffic and is set to QoS level 3—the highest level
- All other DSCP values are set to QoS level 0 (the lowest level—Best Effort).

### Packet Filtering QoS classification

- Filter rules can be used to redefine the QoS priority level to override defaults. See [“Filters” on page 400](#). This allows the QoS priority level to be assigned based on protocol, source, or destination.

### Voice Support

- The QoS priority implementation on the AP gives voice packets the highest priority to support voice applications.

### High Density 2.4G Enhancement—Honeypot SSID

Some situations pose problems for all wireless APs. For example, iPhones will remember every SSID and flood the airwaves with probes, even when the user doesn't request or desire this behavior. In very high density deployments, these probes can consume a significant amount of the available wireless bandwidth.

The AP “honeypot” SSID targets this problem. Simply create an SSID named **honeypot** (lower-case) on the AP, with no encryption or authentication (select **None/Open**). Once this SSID is created and enabled, it will respond to any station probe looking for a named open SSID (unencrypted and unauthenticated) that is *not* configured on the AP. It will make the station go through its natural authentication and association process. See [“Honeypots” on page 306](#).

The following SSIDs are excluded from being honeypotted:

- Explicitly whitelisted SSIDs. See [“Honeypots” on page 306](#).
- SSIDs that are encrypted and/or authenticated.
- SSIDs that are configured on this AP, whether or not they are enabled.

Traffic for a station connected to the honeypot SSID may be handled in various ways using other AP features:

- Traffic may be directed to WPR (captive portal) to display a splash page or offer the user the opportunity to sign in to your service (see [“Web Page Redirect \(Captive Portal\) Configuration” on page 293](#));
- Traffic may be filtered (see [“Filters” on page 398](#));
- or it may be dead-ended by defining a specific dead-end VLAN on the honeypot SSID to “trap” stations (see [“VLANs” on page 217](#)).

*Use the honeypot feature carefully* as it could interfere with legitimate SSIDs and prevent clients from associating to another available network. You may define a whitelist of allowed SSIDs which are not to be honeypotted. See [“Honeypots” on page 306](#). The Honey pots page also allows you to change the SSID name that is broadcast for the honeypot SSID.

## SSID Management

This window allows you to manage SSIDs (create, edit, schedule, rename, and delete), assign security parameters and VLANs on a per SSID basis, and configure the Web Page Redirect (WPR captive portal) functionality.

The screenshot displays the SSID Management configuration page. At the top, there are tabs for SSID, Enabled, Brdcast, Band, VLAN ID / Number, QoS, DHCP Pool / Opt, Filter List, Encryption / Authentication / Global, Xirrus Roaming, WPR, Fallback, and Mobile Manag. Below these are several rows of configuration options for different SSIDs, including SSID name, enabled status, broadcast status, band, VLAN ID, QoS, DHCP pool, filter list, encryption/authentication, Xirrus roaming, WPR, and fallback. The main configuration area is divided into several sections: Limits (Stations, Overall Traffic, Traffic per Station), Scheduling (Days Active, Time Active), Web Page Redirect Configuration (Landing Page URL, Background Image, Logo Image, Header Text File, Footer Text File, Authentication Timeout, Personal Wi-Fi), WPA Configuration (Encryption Ciphers, Authentication, Preshared Key, Verify Key), and Authentication Service Configuration (Authentication Server, Accounting). Arrows point from the legend below to specific fields in the interface: 'Create new SSID' points to the 'Create a New SSID' field; 'Configure parameters' points to the 'Limits' section; 'Configure WPR' points to the 'Web Page Redirect Configuration' section; 'Configure WPA' points to the 'WPA Configuration' section; 'Set traffic limits / usage schedule' points to the 'Limits' and 'Scheduling' sections; and 'Configure authentication server' points to the 'Authentication Service Configuration' section.

**Create new SSID**  
**Configure parameters**  
**Configure WPR**  
**Configure WPA**  
**Set traffic limits / usage schedule**  
**Configure authentication server**

Figure 153. SSID Management

---

### *Procedure for Managing SSIDs*

1. **New SSID:** To create a new SSID, enter a new SSID name. SSID names are case sensitive and may only consist of the characters A-Z, a-z, 0-9, dash, and underscore. You may create up to 16 SSIDs (up to 8 on the XR-500 Series). You may create a special SSID named **honeypot** (lower-case) to reduce the amount of unnecessary traffic caused by stations probing for open SSID names that they have learned in the past—see “[High Density 2.4G Enhancement—Honeypot SSID](#)” on page 281. In this case, a **Honeypot Service Whitelist Configuration** section will appear below (see [Step 1](#) on page 307).

To rename an SSID or schedule a range of dates during which it may be used, see “[SSID Limits and Scheduling](#)” on page 290.

### **SSID List (top of page)**

2. **SSID:** Shows all currently assigned SSIDs. When you create a new SSID, the SSID name appears in this table. Click any SSID in this list to select it.
3. **Enabled:** Check this box to activate this SSID or clear it to deactivate it. Once the SSID is enabled, its availability is also controlled by settings in “[SSID Limits and Scheduling](#)” on page 290.
4. **Brdcast:** Check this box to make the selected SSID visible to all clients on the network. Although the Wireless AP will not broadcast SSIDs that are hidden, clients can still associate to a hidden SSID if they know the SSID name to connect to it. Clear this box if you do not want this SSID to be visible on the network.
5. **Band:** Choose which wireless band the SSID will be beacons on. Select either **5 GHz**—802.11an, **2.4 GHz**—802.11bgn or **Both**.
6. **VLAN ID / Number:** (Optional) From the pull-down list, select a VLAN or VLAN Pool that you want this traffic to be forwarded to on the wired network. Select **numeric** to enter the number of a previously defined VLAN in the **Number** field. See “[VLANs](#)” on page 217 and “[VLAN Pools](#)” on page 219.



7. **QoS:** (Optional) Select a value in this field for QoS (Quality of Service) priority filtering. The QoS value must be one of the following:
  - 0—The lowest QoS priority setting, where QoS makes its best effort at filtering and prioritizing data, video and voice traffic without compromising the performance of the network. Use this setting in environments where traffic prioritization is not a concern.
  - 1—Medium, with QoS prioritization aggregated across all traffic types.
  - 2—High, normally used to give priority to video traffic.
  - 3—The highest QoS priority setting, normally used to give priority to voice traffic.

The QoS setting you define here will prioritize wireless traffic for this SSID over other SSID traffic, as described in [“Understanding QoS Priority on the Wireless AP” on page 277](#). The default value for this field is 2.

8. **DHCP Pool:** If you want to associate an internal DHCP pool to this SSID, choose the pool from the pull-down list. An internal DHCP pool must be created before it can be assigned. To create an internal DHCP pool, go to [“DHCP Server” on page 204](#).
9. **DHCP Option:** When this option is enabled, the AP snoops station DHCP requests and inserts relay agent information into these DHCP packets (option 82, in the CIRCUIT-ID sub-option). Information inserted includes AP MAC address and SSID name. You may use this option here or on the [Tunnel Management](#) page, but not in both places. Information is inserted as a colon-separated text string in the CIRCUIT ID value field, in this format: [AP\_MAC]:[SSID]

[AP\_MAC] length = 17 (aa-bb-cc-dd-ee-ff)

[SSID] length = length of SSID name

Example: aa-bb-cc-dd-ee-ff:mySSID

Note that the MAC address uses *dashes* as separators, and that format is different than that used for Option 82 with Tunnels.

10. **Filter List:** If you wish to apply a set of filters to this SSID's traffic, select the desired Filter List. See [“Filters” on page 398](#).
11. **Authentication:** The following authentication options are available (only valid encryption/authentication combinations are offered):

- **Open:** This option provides no authentication and is not recommended.
- **RADIUS MAC:** Uses an external RADIUS server to authenticate stations onto the wireless network, based on the user's MAC address. Accounting for these stations is performed according to the accounting options that you have configured specifically for this SSID or globally (see [Step 13](#) below).



*If this SSID is on a VLAN, the VLAN must have management turned on in order to pass CHAP authentication challenges from the client station to the RADIUS server.*

- **802.1x:** Authenticates stations onto the wireless network via a RADIUS server using 802.1x with EAP. The RADIUS server can be internal (provided by the Wireless AP) or external.
12. **Encryption:** Choose the encryption that will be required—specific to this SSID—either **None**, **WEP**, **WPA**, **WPA2** or **WPA-Both**. The None option provides no security and is not recommended; WPA2 provides the best Wi-Fi security.

Each SSID supports only one encryption type at a time (except that WPA and WPA2 are both supported on an SSID if you select WPA-Both). If you need to support other encryption types, you must define additional SSIDs. The encryption used with WPA or WPA2 is selected in [“Global Settings” on page 255](#). For an overview of the security options, see [“Security Planning” on page 60](#) and [“Understanding Security” on page 231](#).

13. **Global:** Check this box if you want this SSID to use the security settings established at the global level (see [“Global Settings” on page 255](#)). Clear this box if you want the settings established here to take precedence.

The screenshot displays the SSID Management configuration interface, divided into four main sections:

- Web Page Redirect Configuration:** Includes fields for Landing Page URL, Background Image, Logo Image, Header Text File, Footer Text File, and Authentication Timeout (1 - 10080 or none). It also features a Server selection (Internal Splash, Internal Login, External Login, Cloud, External Splash, Landing Page Only) and RADIUS Authentication Type (PAP, HTTP, HTTPS) with associated URL and Secret fields.
- WPR Whitelist Configuration:** A simple form with a Name field, a Create button, and a Delete All button.
- WPA Configuration:** Shows Encryption Ciphers (AES, TKIP) and Authentication (EAP, PSK, U-PSK). It includes a Preshared Key field with a Hex checkbox and a Verify Key field with a Set button.
- Authentication Service Configuration:** Features Authentication Servers (Active Directory, Internal Radius, External Radius) and Accounting. The External Radius and Accounting sections include tables for configuring Host / IP Address, Port, and Shared Secret.

Two arrows originate from the bottom of the WPA and Authentication Service Configuration sections, pointing to the text: **Set Encryption** and **Configure Radius, Accounting**.

Figure 154. SSID Management—Encryption, Authentication, Accounting

Additional sections will be displayed to allow you to configure encryption, authentication server, and RADIUS accounting settings.

- The **WPA Configuration** encryption settings have the same parameters as those described in [“Procedure for Configuring Network Security”](#) on page 255.

The **U-PSK** (User-PSK) Authentication settings are only used in conjunction with Cloud’s EasyPass Onboarding Portals. The Cloud automatically configures this setting for an SSID when you create an Onboarding portal and you assign that SSID to the portal. Thus, you should *not* normally change this setting manually. Note that the User-PSK settings are only available here, on the [SSID Management](#) page (i.e., they are configured per SSID rather than in [Global Settings](#)).

EasyPass Onboarding facilitates “Bring Your Own Device (BYOD)” usage. The Cloud’s onboarding lets you create user accounts in advance, and a user can self-register a number of devices simply by connecting to the wireless network from each device. Each user account is assigned a User-Preshared Key (U-PSK) to be used for registering each device and accessing the wireless network.

**U-PSK** should only be enabled for an SSID that is assigned to an EasyPass Onboarding portal. The Cloud will also automatically generate a unique Preshared Key for each user account.

**U-PSK Cache Timeout** (minutes)—this local cache on the AP stores the station’s preshared key that was authenticated by the cloud. The cache saves time the next time that the station associates to the AP, since there is no need to query the U-PSK cloud server again. U-PSK Cache Timeout specifies how long the cached entry is used before it must be re-validated.

**U-PSK Server Error** specifies what to do if the U-PSK server in the cloud cannot be accessed to check station authentication status. You may **Allow** station traffic if the server is unavailable, or **Block** it.

- To configure **Active Directory** settings, see [“Active Directory” on page 266](#)).
  - The **External RADIUS** and **Accounting** settings are configured in the same way as for an external RADIUS server (see [“Procedure for Configuring an External RADIUS Server” on page 260](#)). Note that external RADIUS servers may be specified using IP addresses or domain names.
- 14. Roaming:** For this SSID, select whether to enable fast roaming between IAPs or APs at **L2&L3** (Layer 2 and Layer 3), at **L2** (Layer 2 only), or disable roaming (**Off**). You may only select fast roaming at Layers 2 and 3 if this has been selected in [Global Settings](#). See [“Understanding Fast Roaming” on page 318](#).

- 15. WPR (Web Page Redirect**, also called captive portal): Check the checkbox to enable the Web Page Redirect functionality, or clear it to disable this option. If enabled, WPR configuration fields will be displayed under the SSID Limits section. This feature may be used to provide an alternate mode of authentication, or to simply display a splash screen when a user first associates to the wireless network. After that, it can (optionally) redirect the user to an alternate URL. For example, some wireless devices and users may not have a correctly configured 802.1x (RADIUS) supplicant. Utilizing WPR's Web-based login, users may be authenticated without using an 802.1x supplicant. See [“Web Page Redirect \(Captive Portal\) Configuration” on page 293](#) for details of WPR usage and configuration. If your venue is using Purple WiFi for guest access, see also [“Web Page Redirect for Purple WiFi Venues” on page 300](#).

You may specify “Whitelist” entries—a list of web sites to which users have unrestricted access, without needing to be redirected to the WPR page first. See [“Whitelist Configuration for Web Page Redirect” on page 299](#) for details.



*When using WPR, it is particularly important to adhere to the SSID naming restrictions detailed in [Step 1](#).*

- 16. Fallback:** Network Assurance checks network connectivity for the AP. When Network Assurance detects a failure, perhaps due to a bad link or [WDS](#) failure, if Fallback is set to **Disable** the AP will automatically disable this SSID. This will disassociate current clients, and prevent new clients from associating. Since the AP's network connectivity has failed, this gives clients a chance to connect to other, operational parts of the wireless network. No changes are made to WDS configuration. See [Step a on page 248](#) for more information on Network Assurance.
- 17. Mobile Device Management (MDM):** If you are an AirWatch customer and wish to have AirWatch manage mobile device access to the wireless network on this SSID, select **AirWatch** from the drop-down list. Before selecting this option, you must configure your [AirWatch](#) settings. See [“AirWatch” on page 407](#).



*Note that you cannot use MDM and WPR on the same SSID.*

The lower part of the window contains a few sections of additional settings to configure for the currently selected SSID, depending on the values chosen for the settings described above.

- [“SSID Limits and Scheduling” on page 290](#)
- [“Web Page Redirect \(Captive Portal\) Configuration” on page 293](#)
- [“Whitelist Configuration for Web Page Redirect” on page 299](#)
- [“WPA Configuration” on page 303](#)
- [“Authentication Service Configuration” on page 303](#)

### SSID Limits and Scheduling

See [“Group Limits” on page 315](#) for a discussion of the interaction of SSID limits and group limits. To eliminate confusion, we recommend that you configure one set of limits or the other, but not both.

- 18. Stations:** Enter the maximum number of stations allowed on this SSID. This step is optional. Note that the IAPs - Global Settings window also has a station limit option—**Max Station Association per IAP**, and the windows for [Global Settings .11an](#) and [Global Settings .11bgn](#) also have **Max Stations** settings. If multiple station limits are set, all will be enforced. As soon as any limit is reached, no new stations can associate until some other station has terminated its association.
- 19. Overall Traffic:** Choose **Unlimited** if you do not want to place a restriction on the traffic for this SSID, or enter a value in the **Packets/Sec** field to force a traffic restriction.
- 20. Traffic per Station:** Choose **Unlimited** if you do not want to place a restriction on the traffic per station for this SSID, or enter a value in the **Packets/Sec** field or the **Kbps** field to force a traffic restriction. If you set both values, the AP will enforce the limit it reaches first.



- 21. Rename SSID:** Use this field if you wish to change the name of an SSID without changing any of its other settings. For example, a convention center might wish to change the SSID name based on the name of the current exhibition.

### *Scheduling*

- 22. Days Active:** Choose **Everyday** if you want this SSID to be active every day of the week, or select only the specific days that you want this SSID to be active. Days that are not checked are considered to be the inactive days.
- 23. Time Active:** Choose **Always** if you want this SSID active without interruption, or enter values in the **Time On** and **Time Off** fields to limit the time that this SSID is active.
- 24. Date on:** Use this and the following two fields for *SSID Scheduling*—this lets you set up an SSID in advance and specify a period of time for the SSID to be in service. For example, a convention center might wish to set up SSIDs ahead of time for exhibitions that are scheduled for the next six months, and have each SSID be used only for the specified period.

The SSID must be **Enabled** (see [Step 1 on page 284](#)), or the scheduling settings will be ignored. Note that once the SSID has reached its scheduled time and is in service, it will then obey the settings for **Days Active** and **Time Active** above.

Set **Date on** to **none** (the default) if you don't want this SSID to be delayed until later—that is, it will be put in service starting immediately. Select **Specific Date & Time** to have the SSID start become active at the specified date and time. Use the format YYYY-MM-DD [HH:MM], where time (hour and minute) is optional. For example, enter **2016:09:29 08:00**. Use **After Duration** to delay for the specified amount of time in days, hours, and minutes, before the SSID is in service (use the format DD HH:MM, including the hours and minutes). For example, to have the SSID become valid after one day, one hour and 30 minutes have passed, enter **1 01:30**.

25. Use **Date off** to specify a date to take the SSID out of service without deleting it. At the specified date, the AP will turn the **Enabled** flag off. Leave **Expiration** and **Date off** set to **none** (the default) if you want this SSID to remain in service indefinitely after its scheduled start. Use **Specific Date & Time** to take the SSID out of service at the specified date and time. Use the format YYYY-MM-DD [HH:MM], where time (hour and minute) is optional. For example, enter **2016:09:29 18:00**. Use **After Duration** to keep the SSID in service for the specified amount of time in days, hours, and minutes (use the format DD [HH:MM], where hours and minutes are optional).
26. Use **Expiration** to specify a date to *delete this SSID* when it is taken out of service at the specified date (i.e., this option cleans up after itself when it reaches the expiration time). Leave **Expiration** and **Date off** set to **none** (the default) if you want this SSID to remain in service indefinitely after its scheduled start. Use **Specific Date & Time** to delete the SSID at the specified date and time. Use the format YYYY-MM-DD [HH:MM], where time (hour and minute) is optional. For example, enter **2016:09:29 18:00**. Use **After Duration** to keep the SSID in service for the specified amount of time in days, hours, and minutes (use the format DD [HH:MM], where hours and minutes are optional).
27. **Web Page Redirect Configuration:** see [“Web Page Redirect \(Captive Portal\) Configuration”](#) on page 293.
28. To delete an SSID, click its **Delete** button  .
29. Click the **Save** button  if you wish to make your changes permanent.



### Web Page Redirect (Captive Portal) Configuration

If you enable WPR, the SSID Management window displays additional fields that must be configured.

If enabled, WPR displays a splash or login page when a client associates to the wireless network and opens a browser to any URL (provided the URL does not point to a resource directly on the client’s device). This intercept occurs for HTTP (port 80) and SSL (port 443) and redirects that traffic for unauthenticated users. (Note that for SSL, the user will be presented with a certificate error that must be accepted to continue.) The user-requested URL is captured, the user’s browser is redirected to the splash or login page, and then the browser is redirected either to your specified landing page, if any, or else back to the captured URL. The landing page may be specified for a user group as well. See [“Group Management” on page 312](#). Note that if you change the management HTTPS port, WPR uses that port, too. See [“HTTPS” on page 247](#).

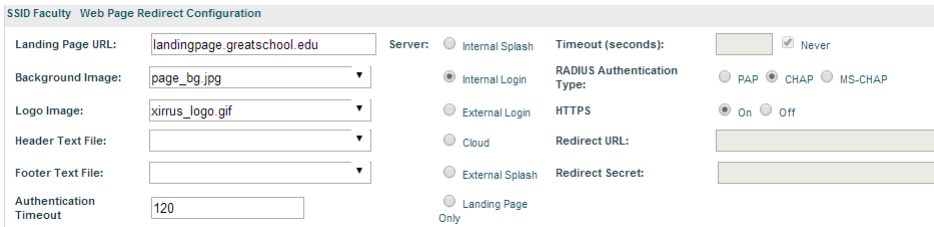

Figure 155. WPR Internal Splash Page Fields (SSID Management)

Note that when clients roam between APs, their WPR Authentication will follow them so that re-authentication is not required.

You may select among several different modes for use of the Web Page Redirect feature, each displaying a different set of parameters that must be entered. For each of these modes, set **Authentication Timeout** to the length of time (in minutes) that an association using the captive portal will remain valid after a user is disconnected. If a user session is interrupted, say if a mobile device goes into power-save mode or a user closes a laptop lid, the user will not have to reauthenticate unless the length of the disconnection is longer than the timeout. The default is 120 minutes. The maximum timeout is 10080 minutes (seven days).

Note that there is an additional setting available for configuring Web Page Redirect for use with Facebook Wi-Fi—see [“Web Page Redirect—HTTPS Pass-through for Facebook Wi-Fi”](#) on page 500.

Web Page Redirect offers the following modes.

- **Internal Login** page

This option displays a login page (residing on the AP) instead of the first user-requested URL. There is an upload function that allows you to replace the default login page, if you wish. Please see [“Web Page Redirect \(Captive Portal\)”](#) on page 424 for more information.

To set up internal login, set **Server** to **Internal Login**. Set **HTTPS** to **On** for a secure login, or select **Off** to use HTTP. You may also customize the login page with logo and background images and header and footer text. See [“Customizing an Internal Login or Splash page”](#) on page 298.

The user name and password are obtained by the login page. Authentication occurs according to your selection—**PAP**, **CHAP**, or **MS-CHAP**. Note that if you select CHAP, then you cannot select **Active Directory** in [“Authentication Service Configuration”](#) on page 303.

After authentication, the browser is redirected back to the captured URL. If you want the user redirected to a specific landing page instead, enter its address in **Landing Page URL**.



*Both the Internal Login and External Login options of WPR perform authentication using your configured RADIUS servers.*

- **Internal Splash** page

This option displays a splash page instead of the first user-requested URL. The splash page files reside on the AP. Note that there is an upload function that allows you to replace the default splash page, if you wish. Please see [“Web Page Redirect \(Captive Portal\)”](#) on page 424 for more information. You may also customize the splash page with logo and background images and header and footer text. See [“Customizing an Internal Login or Splash page”](#) on page 298.

To use an internal splash page, set **Server** to **Internal Splash**. Enter a value in the **Timeout** field to define how many seconds the splash screen is displayed before timing out, or select **Never** to prevent the page from timing out automatically. After the splash page, the user is redirected to the captured URL. If you want the user redirected to a specific landing page instead, enter its address in **Landing Page URL**.

- **External Login page**

This option redirects the user to a login page on an external web server for authentication, instead of the first user-requested URL. Login information (user name and password) must be obtained by that page, and returned to the AP for authentication.

Authentication occurs according to your configured RADIUS information. These parameters are configured as described in [“Procedure for Configuring Network Security” on page 255](#), except that the **RADIUS Authentication Type** is selected here, as described below. After authentication, the browser is redirected back to the captured URL. If you want the user redirected to a specific landing page instead, enter its address in **Landing Page URL**.

To set up external login page usage, set **Server** to **External Login**. Enter the URL of the external web server in **Redirect URL**, and enter that server’s shared secret in **Redirect Secret**.

Select the **RADIUS Authentication Type**. This is the protocol used for authentication of users, **CHAP** or **PAP** (the default).

- Password Authentication Protocol (**PAP**), is a simple protocol. PAP transmits ASCII passwords over the network “in the clear” (unencrypted) and is therefore considered insecure.
- Challenge-Handshake Authentication Protocol (**CHAP**) is a more secure Protocol. The login request is sent using a one-way hash function.
- **External Splash page**

This option displays a splash page instead of the first user-requested URL. The splash page files reside on an external web server.

To set up external splash page usage, set **Server** to **External Splash**. Enter the URL of the external web server in **Redirect URL**, and enter that server's shared secret in **Redirect Secret**.

After the splash page, the user is redirected to the captured URL. If you want the user redirected to a specific landing page instead, enter its address in **Landing Page URL**.

- **Cloud**

This option is only used in conjunction with the Guest Access feature in [XMS-Cloud Next Generation \(XMS-9500-CL-x\)](#). If enabled, **Cloud** redirects the user to a login page hosted in the cloud by XMS for authentication, instead of the first user-requested URL. Login information (user name and password) is obtained by that Cloud Login page, and returned to the AP for authentication.

After authentication, the browser is redirected back to the captured URL. If you want the user redirected to a specific landing page instead, enter its address in **Landing Page URL**.

Cloud Login settings on the AP are entirely managed automatically by XMS-Cloud, based on the configuration that the network administrator has selected there. *You should not make any changes to the following settings configured by XMS.* XMS will set **Server** to **Cloud Login** and set the values of **Redirect URL** and **Redirect Secret**.

- **Landing Page Only**

This option redirects the user to a specific landing page. If you select this option, enter the desired address in **Landing Page URL**.

- **Personal Wi-Fi**

This option is only used in conjunction with the EasyPass Personal portal feature in Riverbed management software for APs. Personal Wi-Fi settings on the AP are entirely managed automatically by the management software, based on the settings that have been selected there. *You should not make any changes to the settings configured by the management software.* When an administrator creates an EasyPass Personal

portal in the management software, the corresponding SSID on the AP is configured to enable **Personal Wi-Fi**. The management software also sets the values on the [Personal Wi-Fi](#) page.

When users connect to the SSID that runs the EasyPass Personal portal, they are redirected to a login page hosted in the cloud by the management software. After successful authentication, a user is redirected to a Personal Wi-Fi setup page to specify necessary parameters for this feature: a personal SSID name, preshared key (PSK) and expiration date. This personal SSID is configured on APs by the management software. Users will typically set up the same SSID name and PSK that they use at home, which their smartphones, tablets, and other personal devices are already configured to connect with automatically. For example, if a hotel offers Riverbed Personal Wi-Fi, guests will be able to set up SSIDs that mimic their home networks. Their devices will automatically connect securely for the duration of the guest's stay (until the personal SSID expires). See [“Personal Wi-Fi” on page 308](#) for more details.

The personal SSID is created with the default values shown below.

Encryption / Authentication: 8WPA2-PSK/02.1x	Broadcast: on
Band: both	VLAN Name/Pool: none
QoS: 2	Filter list: none
Roaming: L2	WPR: off
Fallback: off	Mobile Device Mgmt: none
ACL Mode: off	
SSID Active: yes	SSID expiration: per user setting in XMS
DHCP Pool: uses SSID's name, see below	DHCP Opt: off

A DHCP pool is created for each personal SSID using the SSID Name. NAT is enabled, and the IP subnet is 192.168.1.0/24.

In IAP—Global Settings, Block Inter-Station Traffic is set to No.

### Customizing an Internal Login or Splash page

You may customize these pages with a logo and/or background image, and header and/or footer text, as shown below in [Figure 156](#).

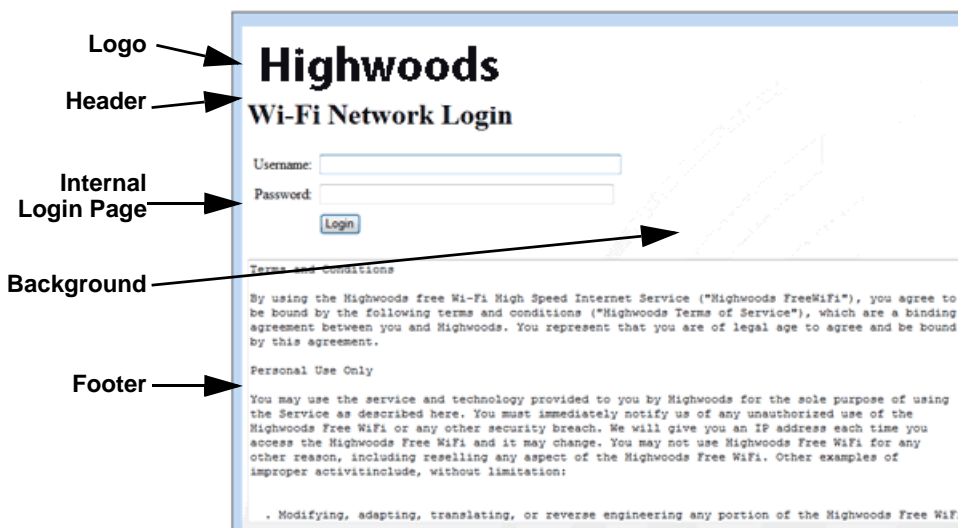
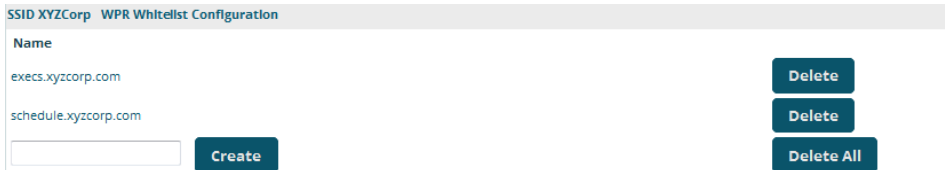

Figure 156. Customizing an Internal Login or Splash Page

- **Background Image**—specify an optional jpg, gif, or png file to display in the background of the page. Other customizations (logo, header, footer) will overlay the background, so that it will not be visible in those areas.
- **Logo Image**—specify an optional jpg, gif, or png file to display at the top of the page.
- **Header Text File**—specify an optional .txt file to display at the top of the page (beneath the logo, if any).
- **Footer Text File**—specify an optional .txt file to display at the bottom of the page.

### Whitelist Configuration for Web Page Redirect

On a per-SSID basis, the whitelist allows you to specify Internet destinations that stations can access without first having to pass the WPR (captive portal) login/splash page. Note that a whitelist may be specified for a user group as well. See “Group Management” on page 312.



SSID XYZCorp WPR Whitelist Configuration

Name

execs.xyzcorp.com

schedule.xyzcorp.com

Figure 157. Whitelist Configuration for WPR

To add a web site to the whitelist for this SSID, enter it in the provided field, then click **Create**. You may enter an IP address or a domain name. Up to 32 entries may be created.

Example whitelist entries:

- Hostname: www.yahoo.com (but not www.yahoo.com/abc/def.html)
- Wildcards are supported: \*.yahoo.com
- IP address: 121.122.123.124

Some typical applications for this feature are:

- to add allowed links to the WPR page
- to add a link to terms of use that may be hosted on another site
- to allow embedded video on WPR page

Note the following details of the operation of this feature:

- The list is configured on a per-SSID basis. You must have **WPR** enabled for the SSID to see this section of the SSID Management page.
- When a station that has not yet passed the WPR login/splash page attempts to access one of the white-listed addresses, it will be allowed access to that site as many times as requested.

- The station will still be required to pass through the configured WPR flow for all other Internet addresses.
- The whitelist will work against all traffic -- not just http or https
- Indirect access to other web sites is not permitted. For example, if you add www.yahoo.com to the whitelist, you can see that page, but not all the ads that it attempts to display.
- The whitelist feature does not cause traffic to be redirected to the whitelist addresses.

### Web Page Redirect for Purple WiFi Venues

**Purple WiFi** is a cloud-based solution that sets up a WiFi hotspot in a business or venue. It offers a number of features such as user analytics, filtering of inappropriate content, marketing, and social media options.

Once you have signed up with Purple WiFi, set up APs as described below. For more details of operation, see “[Purple WiFi Client Login Process Details](#)” on page 302.

To deploy APs in a venue that uses **Purple WiFi** to provide guest access, use the following WPR (captive portal) configuration.

1. On the [SSID Management](#) Page, enable **WPR** on each SSID that is to offer Purple WiFi guest access.
2. Then set the following **Web Page Redirect Configuration** options:
  - **Server:** select **External Login**.
  - **Landing Page URL:** set this to the URL provided by Purple WiFi when you set up your account with them.
  - **Redirect URL:** set this to the URL provided by Purple WiFi when you set up your account with them. For example:

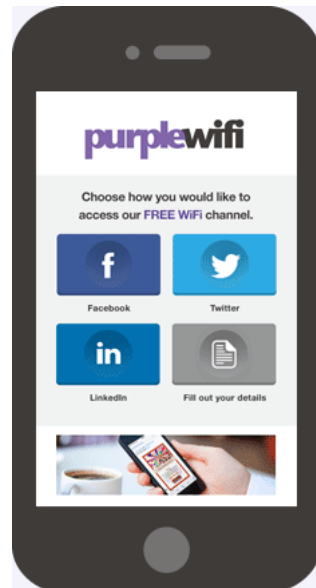

Figure 158. Purple WiFi Guest Access



`http://purpleportal.net/access/`

- **Redirect Secret:** Enter the password provided to you by Purple WiFi.
3. In the next section on the same page, create **WPR Whitelist Configuration** entries as directed by Purple WiFi for web sites that should not be redirected. Note that if an asterisk is part of the entry, you must include this character. For example:

`*.purpleportal.net`

`*.facebook.com`

`api.twitter.com`

`connect.facebook.net`

4. Set the Authentication Server for client access to be the server provided to you by Purple WiFi:
- If you did not select **Global** in [Step 13 on page 286](#), then the Authentication Server will be specific to this SSID, rather than the server used globally on the AP. In the section labeled **Authentication Service Configuration**, enter the following:
    - Set the **Authentication Server** type to **External RADIUS**.
    - Enter the **Host or IP Address**, **Port**, and the **Shared Secret** (password) of the **Primary Server** provided by Purple WiFi.
  - If you did select **Global** in [Step 13 on page 286](#), then the SSID uses the Authentication Server that you defined on the Security > [External Radius](#) Page for global use on the AP. This must be the server provided to you by Purple WiFi. It will be used for all client authentication, unless you define other SSIDs that don't use the global server.

On the Security > [Global Settings](#) Page:

- Set the **Authentication Server Mode** to **External Radius**.

On the Security > [External Radius](#) Page:

- Enter the **Host Name or IP Address**, **Port**, and the **Shared Secret** (password) of the **Primary Server** provided by Purple WiFi.

5. Regardless of whether you selected a global authentication server in [Step 13 on page 286](#), you need the following setting for compatibility with Purple WiFi. On the Security > [External Radius](#) Page, in the **RADIUS Attribute Formatting** section:
  - Set **Called-Station-Id Attribute Format** to **Ethernet MAC**.

### *Purple WiFi Client Login Process Details*

This is an overview of the interaction between the AP and Purple WiFi when a client connects. The client is not aware of any of these details and is led through the process by Purple WiFi's simple interface.

1. A client (smartphone, iPad, etc.) connects to an SSID at a Purple WiFi customer site.
2. The SSID is configured for WPR. As soon as the client opens a browser, it is redirected to the configured Purple WiFi portal page that was configured in the AP **External Login** page, via the **Redirect URL**.
3. The AP contacts the **Redirect URL** along with the AP's MAC address (**Ethernet MAC**). This is used to match the Purple WiFi customer site against a database of AP MAC addresses managed by Purple WiFi, which delivers a customized splash page.
4. The Purple WiFi splash page prompts the end user to log into a social media site.
5. Upon successful authorization at the social media site, a record is then created in the Purple WiFi (**External RADIUS**) database for the client.
6. The Purple WiFi splash page then redirects the browser back to the login script on the AP along with the authentication information (username/password), and the AP then performs an external RADIUS authentication request against the Purple WiFi RADIUS servers (as configured on the AP).

7. If RADIUS authenticates successfully, then the end user is given access to the full Internet, outside of your internal network. Future connections to the same Access Point are automatically authenticated with no user action required.

### WPA Configuration

If you set **Encryption** for this SSID to one of the WPA selections ([Step 12 on page 286](#)) and you did not check the **Global** checkbox ([Step 13](#)), this section will be displayed. The **WPA Configuration** encryption settings have the same parameters as those described in [“Procedure for Configuring Network Security” on page 255](#).

### Authentication Service Configuration

The RADIUS settings section will be displayed if you set **Authentication** ([Step 11 on page 286](#)) to anything but **OPEN**, and you set **Encryption** ([Step 12](#)) to anything but **WEP**, and you did not check the **Global** checkbox ([Step 13](#)). This means that you wish to set up a RADIUS server or Active Directory server to be used for this particular SSID. If **Global** is checked, then the security settings (including the RADIUS server, if any) established at the global level are used instead (see [“Global Settings” on page 255](#)).

The RADIUS and accounting settings are configured in the same way as for an external RADIUS server (see [“Procedure for Configuring an External RADIUS Server” on page 260](#)). If you select **Active Directory**, then the settings are configured in [“Active Directory” on page 266](#). Note that if you select **Active Directory**, then you cannot use CHAP authentication.

### *See Also*

[DHCP Server](#)

[External Radius](#)

[Global Settings](#)

[Internal Radius](#)

[Security Planning](#)

[SSIDs](#)

[Understanding QoS Priority on the Wireless AP](#)

## AirWatch

## Active IAPs

By default, when a new SSID is created, that SSID is active on all IAPs. This window allows you to specify which IAPs will offer that SSID. Put differently, you can specify which SSIDs are active on each IAP.

This feature is useful in conjunction with [WDS](#). You may use this window to configure the WDS link IAPs so that only the WDS link SSIDs are active on them.

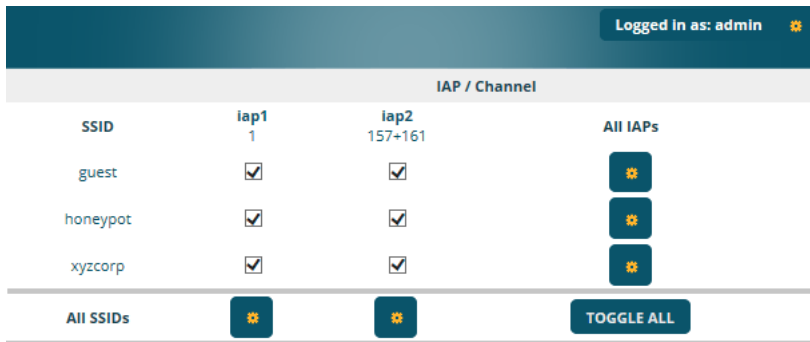

SSID	IAP / Channel		All IAPs
	iap1 1	iap2 157+161	
guest	<input checked="" type="checkbox"/>	<input checked="" type="checkbox"/>	
honeypot	<input checked="" type="checkbox"/>	<input checked="" type="checkbox"/>	
xyzcorp	<input checked="" type="checkbox"/>	<input checked="" type="checkbox"/>	
All SSIDs			<b>TOGGLE ALL</b>

Figure 159. Setting Active IAPs per SSID

### Procedure for Specifying Active IAPs

- SSID:** For a given SSID row, check the IAPs that should offer that SSID to clients. Uncheck any IAPs which should not offer that SSID.
- All IAPs:** This button, in the last column, may be used to allow or deny this SSID on all IAPs, i.e., switch all IAPs between allow or deny.
- All SSIDs:** This button, in the bottom row, may be used to allow or deny all SSIDs on this IAP.
- Toggle All:** This button, on the lower left, may be used to allow or deny all SSIDs on all IAPs.
- Click the **Save** button  if you wish to make your changes permanent.

### Per-SSID Access Control List

This window allows you set up Access Control Lists (ACLs) on a per-SSID basis, to control whether a station with a particular MAC address may associate to a particular SSID. You may create access control list entries and delete existing entries, and control the type of list (allow or deny).

There is one ACL per SSID, and you may select whether its type is an **Allow** list or a **Deny** list, or whether use of this list is **Disabled**. You may create up to 1000 entries per SSID.

There is also a global ACL (see “[Access Control List](#)” on page 253). If the same MAC address is listed in both the global ACL and in an SSID’s ACL, and if either ACL would deny that station access to that SSID, then access will be denied.

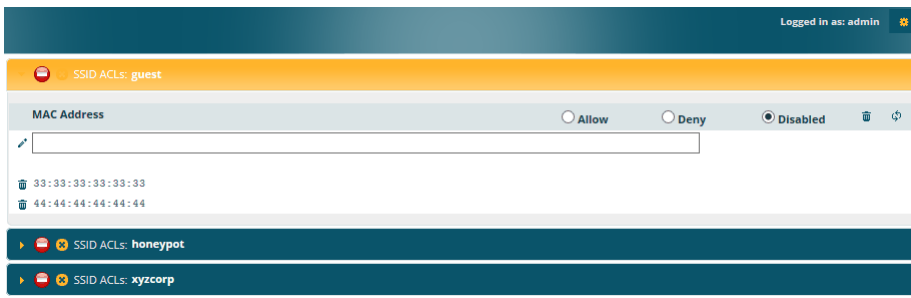





Figure 160. Per-SSID Access Control List



### Procedure for Configuring Access Control Lists

1. **SSID:** Select the line for the SSID whose ACL you wish to manage. Click the line to hide or expand (display) the list.
2. **Access Control List Type:** Select **Disabled** to disable use of the Access Control List for this SSID, or select the ACL type—either **Allow** or **Deny**.
  - **Allow:** Only allows the listed MAC addresses to associate to the AP. All others are denied. The plus symbol  appears before the SSID name for an allow list.

- **Deny List:** Denies the listed MAC addresses permission to associate to the AP. All others are allowed. The minus symbol  appears before the SSID name for a deny list.
- **Disabled:** A red dot  appears before the SSID name for a disabled list. A green dot  appears before the SSID name for an allow or deny list.



*In addition to these lists, other authentication methods (for example, RADIUS) are still enforced for users.*

3. **MAC Address:** If you want to add a MAC address to the ACL for the selected SSID, enter the new MAC address. You may use a wildcard (\*) for one or more digits to match a range of addresses. **Delete:** You may delete selected MAC addresses from this list by clicking their **Delete** buttons  .
4. Click the **Save** button  if you wish to make your changes permanent.

## Honeypots



*Use the honeypot feature carefully as it could interfere with legitimate SSIDs.*

The honeypot SSID feature prevents the airwaves from being crowded with probes for named SSIDs. These probes are automatically generated by some popular wireless devices. When you create and enable a honeypot SSID on an AP, it responds to any station probe looking for a named open SSID (unencrypted and unauthenticated) that is *not* configured on the AP. For more details, see [“High Density 2.4G Enhancement—Honeypot SSID”](#) on page 281.

This page allows you to create a honeypot SSID, enter a whitelist of SSID names that are not to be honeypotted, and define alternate names for the SSID that will be broadcast instead of “honeypot”.

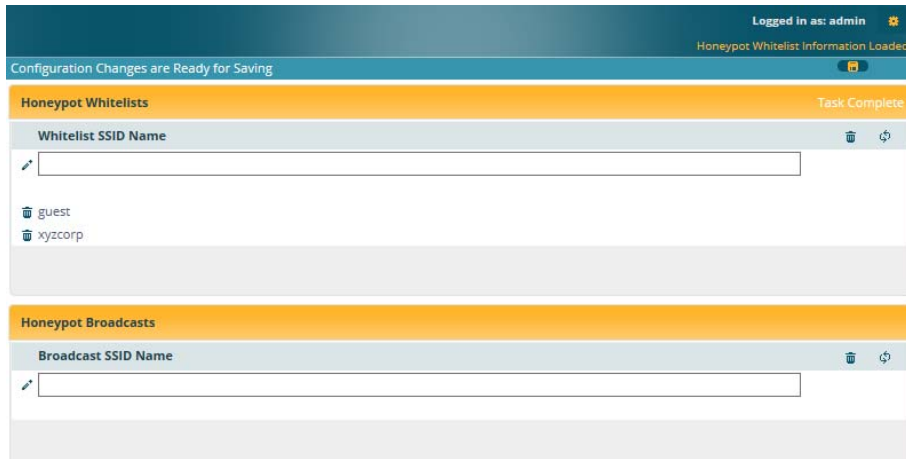

Figure 161. Honeypot Whitelist

### *Procedure for Configuring Honeypot Whitelists*

1. **Create a honeypot:** If you have not already created an SSID named **honeypot**, you will be asked whether you wish to create one. Click **Yes**. You must have an SSID named honeypot to use this feature.
2. **Honeypot Whitelists:** This section only appears if you have created an SSID named honeypot. You may define a whitelist of allowed SSIDs which are not to be honeypotted, as described in [“High Density 2.4G Enhancement—Honeypot SSID” on page 281](#). Type in each SSID name, and click **Create** to add it to the whitelist. Up to 150 SSIDs may be listed. The SSID names entered in this list are not case-sensitive.

You may use the “\*” character as a wildcard to match any string at this position. For example, xir\* matches any string that starts with **XIR** or **xir**. You may use a ? as a wildcard to match a single character by surrounding the SSID name in quotes. For example, “xirru?” will match any six-character long string that starts with **xirru** (again, the match is not case-sensitive). If you do not use a wildcard, then the SSID name entered must be matched exactly in order to be whitelisted (except that case is not considered).

3. **Honeypot Broadcasts:** This section only appears if you have created an SSID named honeypot. You may define one or more alias names for this SSID. They will be broadcast *instead of* the name **honeypot**.

## Personal Wi-Fi

The settings on this page will apply to all of the Personal Wi-Fi SSIDs that are created by users after they connect to an EasyPass Personal portal. See “[Personal Wi-Fi](#)” on page 296. These settings are only used in conjunction with the EasyPass Personal portal feature in XMS, and they are entirely managed automatically by XMS, based on the settings that have been selected there. *You should not make any changes to the settings configured by XMS.*

Limit - All Stations (0-12):

Limit - Per Station (0-4):

Expiration Default:  Format: (YYYY-MM-DD [HH:MM])

Specific Date & Time  After Duration  Never

Figure 162. Personal Wi-Fi

### Settings for Personal Wi-Fi

1. **Limit - All Stations (0-12):** the maximum number of personal SSIDs that may exist on this AP at one time. The default value is 4.
2. **Limit - Per Station (0-4):** the maximum simultaneous number of personal SSIDs that can be created by a single station. The default value is 1.
3. **Expiration Default:** the expiration time for a personal SSID—after this time, the SSID will be deleted. Note that the user may specify an expiration date for a particular personal SSID when it is set up. If expiration times are specified both on this page and for a particular personal SSID, the SSID will expire at whichever time occurs first.

You may enter a **Specific Date & Time** for the personal SSID to expire. Use the format YYYY-MM-DD [HH:MM], where time (hour and minute) is optional. For example, enter **2016:09:29 08:00**. If the hour and minute are omitted, they are assumed to be 23:59.



Use **After Duration** to specify the length of time before the SSID expires, in days, hours, and minutes. Use the format DD [HH:MM], where hours and minutes are optional. For example, to have the SSID expire after one day, one hour and 30 minutes have passed, enter **1 01:30**.

Set **Expiration** to **Never** (the default) if you want this SSID to remain in service indefinitely after its scheduled start.

## Groups

This is a status-only window that allows you to review user (i.e., wireless client) [Group](#) assignments. It includes the group name, Radius ID, Device ID, [VLAN](#) IDs and [QoS](#) parameters and roaming layer defined for each group, and DHCP pools and web page redirect information defined for the group. You may click on a group's name to jump to the edit page for the group. There are no configuration options available on this page, but if you are experiencing problems or reviewing group management parameters, you may want to print this page for your records.

The **Limits** section of this window shows any limitations configured for your defined groups. For example, this window shows the current state of a group (enabled or disabled), how much group and per-station traffic is allowed, time on and time off, and days on and off.

For information to help you understand groups, see [Understanding Groups](#) below.

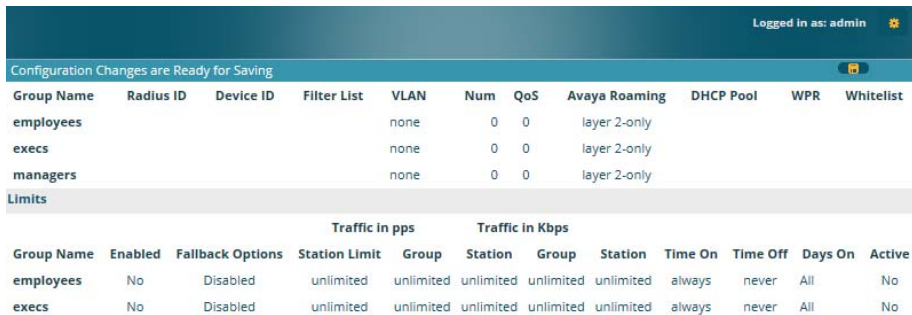

Configuration Changes are Ready for Saving

Logged in as: admin

Group Name	Radius ID	Device ID	Filter List	VLAN	Num	QoS	Avaya Roaming	DHCP Pool	WPR	Whitelist
employees				none	0	0	layer 2-only			
execs				none	0	0	layer 2-only			
managers				none	0	0	layer 2-only			

**Limits**

Group Name	Enabled	Fallback Options	Traffic in pps			Traffic in Kbps			Time On	Time Off	Days On	Active
			Station Limit	Group	Station	Group	Station					
employees	No	Disabled	unlimited	unlimited	unlimited	unlimited	unlimited	always	never	All	No	
execs	No	Disabled	unlimited	unlimited	unlimited	unlimited	unlimited	always	never	All	No	

Figure 163. Groups

## Understanding Groups

User groups allow administrators to assign specific network parameters to users (wireless clients) through RADIUS privileges rather than having to map users to an SSID tailored for that set of privileges. Groups provide flexible control over user privileges without the need to create large numbers of SSIDs.

A group allows you to define a set of parameter values to be applied to selected users. For example, you might define the user group **Students**, and set its VLAN, security parameters, web page redirect (WPR), and traffic limits. When a new user

is created, you can apply all of these settings just by making the user a member of the group. The group allows you to apply a uniform configuration to a set of users in one step.

In addition, you can restrict the group so that it only applies its settings to group members who are connecting using a specific device type, such as iPad or phone. Thus, you could define a group named **Student-Phone** with **Device ID** set to **Phone**, and set the group's **VLAN Number** to 100. This group's settings will only be applied to group members who connect using a phone, and they will all use VLAN 100. Note that settings for the group in the RADIUS server will override any settings on this WMI page. It is possible to create Device IDs for new devices—see “[device-id](#)” on page 465.

Almost all of the parameters that can be set for a group are the same as SSID parameters. This allows you to configure features at the user group level, rather than for an entire SSID. If you set parameter values for an SSID, and then enter different values for the same parameters for a user group, the **user group values have priority** (i.e., group settings will override SSID settings).

Group names are case-sensitive and can contain up to 32 alphanumeric characters (do not include spaces when defining Groups).

### Using Groups

User accounts are used to authenticate wireless clients that want to associate to the AP. These accounts are established in one of two ways, using the **Security> Internal Radius** window or the **Security> External Radius** window. In either case, you may select a user group for the user, and that user group's settings will apply to the user:

- **Internal Radius**—when you add or modify a user entry, select a user group to which the user will belong.
- **External Radius**—when you add or modify a user account, specify the **Radius ID** for the user group to which the user will belong. This must be the same Radius ID that was entered in the [Group Management](#) window. When the user is authenticated, the external Radius server will send the Radius ID to the AP. This will allow the AP to identify the group to which the user belongs.

*See Also*[External Radius](#)[Internal Radius](#)[SSIDs](#)[Understanding QoS Priority on the Wireless AP](#)[Web Page Redirect \(Captive Portal\) Configuration](#)[Understanding Fast Roaming](#)**Group Management**

This window allows you to manage groups (create, edit and delete), assign usage limits and other parameters on a per group basis, and configure the Web Page Redirect (captive portal) functionality.

Configuration Changes are Ready for Saving

Group	Enabled	Fallback Options	Radius ID	Device ID	VLAN ID / Number	QoS	DHCP Pool	Filter List	Avaya Roaming	WPR
employees	<input type="checkbox"/>	None		(none)	(none)	0	(none)	(none)	L2	<input type="checkbox"/>
execs	<input type="checkbox"/>	None		(none)	(none)	0	(none)	(none)	L2	<input type="checkbox"/>
managers	<input type="checkbox"/>	None		(none)	(none)	0	(none)	(none)	L2	<input type="checkbox"/>

Group managers Limits

Stations:

Overall Traffic:  Packets/Sec  Unlimited  Limited

Days Active:  Everyday  Sun  Mon  Tue  Wed  Thu  Fri  Sat

Time Active:  Always  Time On:

Traffic per Station:  Packets/Sec  Unlimited  Limited

Kbps  Unlimited  Limited

Time Off:

Figure 164. Group Management

**Procedure for Managing Groups**

- 1. New Group Name:** To create a new group, enter a new group name next to the Create button, then click **Create**. You may create up to 16 groups (up to 8 on the XR-500 Series).

To configure and enable this group, proceed with the following steps.

- 2. Group:** This column lists currently defined groups. When you create a new group, the group name appears in this list. Click on any group to select it, and then proceed to modify it as desired.

3. **Enabled:** Check this box to enable this group or leave it blank to disable it. When a group is disabled, users that are members of the group will behave as if the group did not exist. In other words, the options configured for the SSID will apply to the users, rather than the options configured for the group.
4. **Fallback:** Network Assurance checks network connectivity for the AP. When Network Assurance detects a failure, perhaps due to a bad link or [WDS](#) failure, if Fallback is set to **Disable** the AP will automatically disable users in this group. This will disassociate current clients, and prevent them from re-associating. Since the AP's network connectivity has failed, this gives clients a chance to connect to other, operational parts of the wireless network. See [Step a on page 248](#) for more information on Network Assurance.
5. **Radius ID:** Enter a unique Radius ID for the group, to be used on an external Radius server. When adding a user account to the external server, this Radius ID value should be entered for the user. When the user is authenticated, Radius sends this value to the AP. This tells the AP that the user is a member of the group having this Radius ID.
6. **Device ID:** You may select a device type from this drop-down list, for example, **Notebook**, **Phone**, **iPhone**, or **Android**. This allows you to apply the group settings only if a station authenticates as a user that is a member of the group and the station's device type matches **Device ID**. **Select none** if you do not want to consider the device type. If you have a Radius ID you should not enter a Device ID.
7. **VLAN ID:** (Optional) From the pull-down list, select a VLAN or VLAN Pool for this user's traffic to use (see ["VLANs" on page 217](#) and ["VLAN Pools" on page 219](#)). This user group's VLAN settings supersede Dynamic VLAN settings (which are passed to the AP by the Radius server). To avoid confusion, we recommend that you avoid specifying the VLAN for a user in two places.
8. **QoS Priority:** (Optional) Select a value in this field for QoS (Quality of Service) priority filtering. The QoS value must be one of the following:

- 0—The lowest QoS priority setting, where QoS makes its best effort at filtering and prioritizing data, video and voice traffic without compromising the performance of the network. Use this setting in environments where traffic prioritization is not a concern.
- 1—Medium; QoS prioritization is aggregated across all traffic types.
- 2—High, normally used to give priority to video traffic.
- 3—The highest QoS priority setting, normally used to give priority to voice traffic.

The QoS setting you define here will prioritize wireless traffic for this group versus other traffic, as described in [“Understanding QoS Priority on the Wireless AP” on page 277](#). The default value for this field is 2.

9. **DHCP Pool:** (Optional) To associate an internal DHCP pool to this group, select it from the pull-down list. Only one pool may be assigned. An internal DHCP pool must be created before it can be assigned. To create a DHCP pool, go to [“DHCP Server” on page 204](#).
10. **Filter List:** (Optional) If you wish to apply a set of filters to this user group’s traffic, select the desired Filter List. See [“Filters” on page 398](#).
11. **Riverbed Roaming:** (Optional) For this group, select roaming behavior. Select **L2&L3** to enable fast roaming between IAPs or APs at Layer 2 and Layer 3. If you select **L2**, then roaming uses Layer 2 only. You may only select fast roaming at Layers 2 and 3 if this has been selected in [Global Settings](#). You may select **Off** to disable fast roaming. See [“Understanding Fast Roaming” on page 318](#).
12. **Web Page Redirect (WPR):** (Optional) Check this box if you wish to enable the Web Page Redirect (captive portal) functionality. This will open a **Web Page Redirect** details section in the window, where your WPR parameters may be entered. This feature may be used to display a splash screen when a user first associates to the wireless network. After that, it can (optionally) redirect the user to an alternate URL. See [“Web Page Redirect \(Captive Portal\) Configuration” on page 293](#) for details of WPR configuration. Note that the Group Management window only allows you to set up an **Internal Splash** page and a **Landing Page URL**.

The authentication options that are offered on the SSID Management page are not offered here. Since the group membership of a user is provided to the AP by a Radius server, this means the user has already been authenticated.

You may create a WPR Whitelist on a per-group basis if you wish. See [“Whitelist Configuration for Web Page Redirect” on page 299](#) for details of WPR Whitelist usage and configuration.

### Group Limits

The Limits section allows you to limit the traffic or connection times allowed for this user group. Note that the IAPs—Global Settings window and the SSID management windows also have options to limit the number of stations, limit traffic, and/or limit connection times. If limits are set in more than one place, all limits will be enforced:

- As soon as any station limit is reached, no new stations can associate until some other station has terminated its association.
- As soon as any traffic limit is reached, it is enforced.
- If any connection date/time restriction applies, it is enforced.

You can picture this as a logical AND of all restrictions. For example, suppose that a station’s SSID is available Monday - Friday between 8:00am and 5:00pm, and the User Group is available Monday, Tuesday, Wednesday between 6:00am and 8:00pm, then the station will be allowed on MWF between 8:00am and 5:00pm.

To eliminate confusion, we recommend that you configure one set of limits or the other, but not both.

- 13. Stations:** Enter the maximum number of stations allowed on this group. The default is 1536.
- 14. Overall Traffic:** Check the **Unlimited** checkbox if you do not want to place a restriction on the traffic for this group, or enter a value in the Packets/Sec field and make sure that the Unlimited box is unchecked to force a traffic restriction.

15. **Traffic per Station:** Check the **Unlimited** checkbox if you do not want to place a restriction on the traffic per station for this group, or enter a value in the **Packets/Sec** or **Kbps** field and make sure that the Unlimited box is unchecked to force a traffic restriction.
16. **Days Active:** Choose **Everyday** if you want this group to be active every day of the week, or select only the specific days that you want this group to be active. Days that are not checked are considered to be the inactive days.
17. **Time Active:** Choose **Always** if you want this group active without interruption, or enter values in the **Time On** and **Time Off** fields to limit the time that group members may associate.
18. To delete an entry, click its **Delete** button.
19. Click the **Save** button  if you wish to make your changes permanent.

*See Also*

[DHCP Server](#)

[External Radius](#)

[Internal Radius](#)

[Security Planning](#)

[SSIDs](#)



## IAPs

This status-only window summarizes the status of the Integrated Access Points. For each IAP, it shows whether it is up or down, the channel and wireless mode, the antenna that it is currently using, its cell size and transmit and receive power, how many users (stations) are currently associated to it, whether a WDS link distance has been set for it, and its BSSID (MAC address).

IAP Summary														
IAP	State	AP Type	Band	WiFi Mode	Bond	Primary Channel	Channel Mode	Antenna	Cell Size	TX Power	RX Thresho	Stations	Distance	BSSID
iap1	up	.11abgnac...	2.4GHz	bgn	off	1	manual	intern...	max	20	-90	0		50:60:28:22:cea0-a2
iap2	up	.11abgnac...	5GHz	anac	40mh...	157	auto...	intern...	max	20	-90	1		50:60:28:22:ceb0-b2

Figure 165. IAPs

The **Channel Mode** column displays some status information that is not found elsewhere: the source of a channel setting. (Figure 166) If you set a channel manually (via [IAP Settings](#)), it will be listed as **manual**. If an autochannel operation changed a channel, then it is labeled as **auto**. If the channel is set to the current factory default setting, the source will be **default**. This column also shows whether the channel selection is **locked**, or whether the IAP was automatically switched to this channel because the AP detected the signature of **radar** in operation on a conflicting channel (see also, [Step 8 on page 327](#)).

IAP Summary							
IAP	State	AP Type	Band	WiFi Mode	Bond	Primary Channel	Channel Mode
iap1	up	.11abgnac...	2.4GHz	bgn	off	1	manual
iap2	up	.11abgnac...	5GHz	anac	40mhz...	157	automatic

Figure 166. Source of Channel Setting

There are no configuration options in this window, but if you are experiencing problems or simply reviewing the IAP assignments, you may print this window for your records. Click any IAP name to open the associated configuration page.

APs have a fast roaming feature, allowing them to maintain sessions for applications such as voice, even while users cross boundaries between APs. Fast roaming is set up in the [Global Settings](#) window and is discussed in:

- [“Understanding Fast Roaming” on page 318](#)

IAPs are configured using the following windows:

- [“IAP Settings” on page 319](#)
- [“Global Settings” on page 325](#)
- [“Global Settings .11an” on page 341](#)
- [“Global Settings .11bgn” on page 347](#)
- [“Global Settings .11n” on page 353](#)
- [“Global Settings .11u” on page 358](#)
- [“Global Settings .11ac” on page 356](#)
- [“Advanced RF Settings” on page 364](#)
- [“Hotspot 2.0” on page 373](#)
- [“NAI Realms” on page 375](#)
- [“Intrusion Detection” on page 378](#)
- [“LED Settings” on page 385](#)
- [“DSCP Mappings” on page 387](#)
- [“Roaming Assist” on page 388](#)

### *See Also*

[IAP Statistics Summary](#)

### **Understanding Fast Roaming**

To maintain sessions for real-time data traffic, such as voice and video, users must be able to maintain the same IP address through the entire session. With traditional networks, if a user crosses VLAN or subnet boundaries (i.e., roaming between domains), a new IP address must be obtained.

Mobile wireless users are likely to cross multiple roaming domains during a single session (especially wireless users of VoIP phones). **Layer 3 roaming** allows

a user to maintain the same IP address through an entire real-time data session. The user may be associated to any of the VLANs defined on the AP. The Layer 3 session is maintained by establishing a tunnel back to the originating AP. You should decide whether or not to use Layer 3 roaming based on your wired network design. Layer 3 roaming incurs extra overhead and may result in additional traffic delays. You may configure one SSID for Layer 3 fast roaming with up to 25 APs.

Fast Roaming is configured on two pages. To enable the fast roaming options that you want to make available on your AP, see [Step 31](#) to [Step 33](#) in “Global Settings” on page 325. To choose which of the enabled options are used by an SSID or Group, see “Procedure for Managing SSIDs” on page 284 (Step 14) or “Procedure for Managing Groups” on page 312.

### IAP Settings

This window allows you to enable/disable IAPs, define the wireless mode for each IAP, specify the channel and bond width and the cell size for each IAP, lock the channel selection, establish transmit/receive parameters, and reset channels. Buttons at the top of the list allow you to **Reset Channels**, **Enable All IAPs**, or **Disable All IAPs**. When finished, click the **Save** button  if you wish to make your changes permanent.



IAP	Frequency	Mode	Channel	Power	Cell Size	RX Threshold	Antenna
iap1	2.4GHz	bgn	1	20 dBm	max	-90 dBm	internal omni
iap2	5GHz	anac	157 161	40mhz	max	-90 dBm	0 miles

Figure 167. IAP Settings



You may also access this window by clicking on the AP image at the lower left of the WMI window—click the Riverbed logo in the center of the AP. See “[User Interface](#)” on page 94.

### *Procedure for Auto Configuring IAPs*

You can auto-configure channel and cell size of radios by clicking on the **Auto Configure** buttons on the appropriate WMI page as shown below (auto configuration only applies to enabled radios):

- For all radios, go to “[Advanced RF Settings](#)” on page 364.
- For all 802.11a settings, go to “[Global Settings .11an](#)” on page 341.
- For all 802.11bg settings, go to “[Global Settings .11bgn](#)” on page 347.
- For all 802.11n settings, go to “[Global Settings .11n](#)” on page 353.
- For all 802.11ac settings, go to “[Global Settings .11ac](#)” on page 356.

### *Procedure for Manually Configuring IAPs*

1. The row for each IAP summarizes its settings. Click to expand it and display the settings. Click again to collapse the entry.
2. In the **Enable** field select **enabled**, or select **disabled** if you want to turn off the IAP. The state of the channel is displayed with a green dot  if enabled, and a red dot  if disabled.
3. In the **Band** field, select the wireless band for this IAP from the choices available in the pull-down menu, either **2.4GHz** or **5 GHz**. Choosing the **5GHz** band will automatically select an adjacent channel for bonding. If the band displayed is **auto**, the **Band** is about to be changed based on a new **Channel** selection that you made that requires the change.



*For XR-520 Series APs only:*

—*iap1* may be set to either band or to monitor (also see the *Timeshare* option in “[RF Monitor](#)” on page 365).

—*iap2* is permanently set to 5 GHz.

One of the IAPs must be set to **monitor** mode if you wish to support [Spectrum Analyzer](#), Radio Assurance (loopback testing), and [Intrusion Detection](#) features. We recommend using **iap1** for monitoring on AP models with up to four radios, as this radio assignment results in the best overall traffic throughput for the AP. Monitoring has a **Timeshare** mode option, which is especially useful for small APs with two IAPs allowing one IAP to be shared between monitoring the airwaves for problems and providing services to stations. See **RF Monitor Mode** in [“Advanced RF Settings” on page 364](#) to set this option.

4. In the **WiFi Mode** field, select the IEEE 802.11 wireless mode (or combination) that you want to allow on this IAP. The drop-down list will only display the appropriate choices for the selected **Band**. For example, the 5 GHz band allows you to select **ac-only**, **anac**, **an**, **a-only**, or **n-only**, while 2.4GHz includes 802.11b and 802.11g choices. When you select a WiFi Mode for any IAP, your selection in the **Channel** column will be checked to ensure that it is a valid choice for that WiFi Mode.

By selecting appropriate WiFi Modes for the radios on your APs, you can greatly improve wireless network performance. For example, if you have 802.11n and 802.11ac stations using the same IAP, throughput on that radio is reduced greatly for the 802.11ac stations. By supporting 802.11n stations only on selected radios in your network, the rest of your 802.11ac IAPs will have greatly improved performance. Take care to ensure that your network provides adequate coverage for the types of stations that you need to support.

5. In the **Channel** field, select the [channel](#) you want this IAP to use from the channels available in the pull-down list. The list shows the channels available for the IAP selected (depending on which band the IAP is using). Channels that are shown in gray are unavailable. They are either already in use, or not offered for the selected Band.

The channels that are available for assignment to IAPs will differ, depending on the country of operation. If **Country** is set to **United States** in the [Global Settings](#) window, then 21 channels are available to 802.11an radios.



*As mandated by FCC/IC law, APs continually scan for signatures of radar. If such a signature is detected, the AP will switch operation from conflicting channels to new ones. The AP will switch back to the original channel after 30 minutes if the channel is clear. If a radio was turned off because there were no available channels not affected by radar, the AP will now bring that radio back up after 30 minutes if that channel is clear. The 30 minute time frame complies with FCC/IC regulations.*

6. Set **Channel Lock** to **Block auto-channel assignment** if you want to lock in your channel selection so that an autochannel operation (see [Advanced RF Settings](#)) can't change it. A locked padlock  will be displayed for the IAP.
7. The **Bond** field works together with the **Channel** selected above. (For 802.11n IAPs, it also obeys the bonding options selected on the [Global Settings .11n](#) page.) Also see the discussion in “[Higher Channel Widths \(Bonding\)](#)” on page 52. Bonding is available on all APs, including two-radio models. For 802.11n, two 20MHz channels may be bonded to create one 40MHz channel with double the data rate. 802.11ac offers an additional option to bond four 20MHz channels to create one 80MHz channel with four times the data rate.
  - **Channel number**—If a channel number appears, then this channel is already bonded to the listed channel.
  - **Off**—Do not bond this channel to another channel.
  - **40MHz**—Bond this channel to an adjacent channel. The bonded channel is selected automatically by the AP based on the **Channel** ([Step 5](#)). The choice of bonded channel is static—fixed once the selection is made.
  - **80MHz**—Bond this channel to three adjacent channels. The bonded channels are selected automatically by the AP based on the **Channel** ([Step 5](#)). The choice of bonded channels is static—fixed once the selection is made.

The top line for the IAP will show the channels that have been assigned based on the width of the bond.

8. In the **Cell Size** field, select **auto** to allow the optimal cell size to be automatically computed (see also, [“RF Power and Sensitivity” on page 367](#)). To set the cell size yourself, choose either **small**, **medium**, **large**, or **max** to use the desired pre-configured cell size. Alternatively, you can set the wireless cell size manually by specifying the transmit and receive power—in dB—in the **Tx Power** (transmit) and **Rx Threshold** (receive) fields. If you set manual values, the Cell Size field will display the value **manual** after the page is refreshed.

The default for Cell Size is **max**. If you select a value other than **auto**, the cell size will not be affected by cell size auto configuration. Note that ultra low power **Tx dBm** settings are possible. Values from -15dB to 5dB are provided specifically to help in high density 2.4 GHz environments.

When other APs are within listening range of this one, setting cell sizes to **Auto** allows the AP to change cell sizes so that coverage between cells is maintained. Each cell size is optimized to limit interference between sectors of other APs on the same channel. This eliminates the need for a network administrator to manually tune the size of each cell when installing multiple APs. In the event that an AP or a radio goes offline, an adjacent AP can increase its cell size to help compensate.

The number of users and their applications are major drivers of bandwidth requirements. The network architect must account for the number of users within the AP’s cell diameter. In a large office, or if multiple APs are in use, you may choose **Small** cells to achieve a higher data rate, since walls and other objects will not define the cells naturally.

For additional information about cell sizes, go to [“Coverage and Capacity Planning” on page 38](#).

9. If you are using [WDS](#) to provide backhaul over an extended distance, use **WDS Distance (Miles)** to prevent timeout problems associated with long transmission times. Set the approximate distance in miles between this IAP and the connected AP in this column. This increases the wait time for frame transmission accordingly.

10. The **Antenna** field displays the antenna that has automatically been selected for this IAP.
11. If desired, enter a description for this IAP in the **Description** field.
12. You may reset all of the enabled IAPs by clicking the **Reset Channels** button at the top of the list. A message will inform you that all enabled radios have been taken down and brought back up.
13. Buttons at the top of the list allow you to **Enable All IAPs** or **Disable All IAPs**.
14. Click the **Save** button  if you wish to make your changes permanent.

*See Also*

[Coverage and Capacity Planning](#)

[Global Settings](#)

[Global Settings .11an](#)

[Global Settings .11bgn](#)

[Global Settings .11n](#)

[Global Settings .11ac](#)

[Advanced RF Settings](#)

[IAPs](#)

[IAP Statistics Summary](#)

[LED Settings](#)



## Global Settings

**Country:** UN - United States (Non-DFS)

**IAP Control:**

**Short Retries (1-128):**

**Long Retries (1-128):**

**Beacon Configuration**

**Beacon Interval (100-1000 Kusec):**

**DTIM Period (1-255 beacons):**

**802.11h Beacon Support:**  Off  On

**802.11k Beacon Support:**  Off  On

**802.11w Protected Management Support:**  Off  On

**WMM Power Save:**  Off  On

**WMM ACM Video:**  Off  On

**WMM ACM Voice:**  Off  On

**Station Management**

**Station Re-Authentication Period (Seconds):**

**Station Timeout Period (Seconds):**

**Max Station Association per Array (1-3840, unlimited):**

**Max Station Association per IAP (1-240):**

**Block Inter-Station Traffic:**  Yes  No

**Allow Over Air Management:**  Yes  No

Figure 168. Global Settings (IAPs)

This window allows you to establish global IAP settings. Global IAP settings include enabling or disabling all IAPs (regardless of their operating mode), and changing settings for beacons, station management, and advanced traffic optimization—including multicast processing, load balancing, and roaming. Changes you make on this page are applied to all IAPs, without exception.

---

### *Procedure for Configuring Global IAP Settings*

1. **Country:** This is a display-only value. Once a country has been set, it may not be changed.

The channels that are available for assignment to IAPs will differ, depending on the country of operation. If **Country** is set to **United States**, then 21 channels are available for 802.11a/n.

If no country is displayed, the channel set defaults to channels and power levels that are legal worldwide—this set only includes the lower eight 5 GHz channels.

2. **IAP Control:** Click on the **Enable All IAPs** button to enable all IAPs for this AP, or click on the **Disable All IAPs** button to disable all IAPs.
3. **Short Retries:** This sets the maximum number of transmission attempts for a **frame**, the length of which is less than or equal to the RTS Threshold, before a failure condition is indicated. The default value is 7. Enter a new value (1 to 128) in the **Short Retry Limit** field if you want to increase or decrease this attribute.
4. **Long Retries:** This sets the maximum number of transmission attempts for a **frame**, the length of which is greater than the RTS Threshold, before a failure condition is indicated. The default value is 4. Enter a new value (1 to 128) in the **Long Retry Limit** field if you want to increase or decrease this attribute.
5. **Wi-Fi Alliance Mode:** Set this **On** if you need AP behavior to conform completely to Wi-Fi Alliance standards. This mode is normally set to **Off**.

### Beacon Configuration

6. **Beacon Interval:** When the AP sends a beacon, it includes with it a beacon interval, which specifies the period of time before it will send the beacon again. Enter the desired value in the **Beacon Interval** field, between 20 and 1000 Kusecs. A Kusec is 1000 microseconds = 1 millisecond. The value you enter here is applied to all IAPs.
7. **DTIM Period:** A Delivery Traffic Indication Message (DTIM) is a signal sent as part of a beacon by the AP to a client device in sleep mode, alerting the device to broadcast traffic awaiting delivery. The **DTIM Period** is a multiple of the **Beacon Interval**, and it determines how often DTIMs are sent out. By default, the DTIM period is 1, which means that it is the same as the beacon interval. Enter the desired multiple, between 1 and 255. The value you enter here is applied to all IAPs.
8. **802.11h Beacon Support:** This option enables beacons on all of the AP's radios to conform to 802.11h requirements, supporting dynamic frequency selection (DFS) and transmit power control (TPC) to satisfy regulatory requirements for operation in Europe.
9. **802.11k Beacon Support:** 802.11k offers faster and more efficient roaming. When enabled, each beacon lists the channels that nearby APs offer. This supports improved channel scanning, resulting in faster roam times and increased battery life due to shorter scan times since the station knows where to look for nearby APs. The AP will also respond to requests from stations for an 802.11K Neighbor Report with additional information about nearby APs. This setting is enabled by default.
10. **802.11w Protected Management Support:** This option protects the wireless network infrastructure against spoofing by outside APs. Authenticate, De-authenticate, Associate, and Dis-associate management frames are sent in a secured manner when this option is enabled.

11. **WMM Power Save:** Click **On** to enable Wireless Multimedia Power Save support, as defined in IEEE802.11e. This option saves power and increases battery life by allowing the client device to doze between packets to save power, while the AP buffers downlink frames. The default setting is **On**.
12. **WMM ACM Video:** Click **On** to enable Wireless Multimedia Admission Control for video traffic. When admission control for video is enabled, the AP evaluates a video request from a client device against the network load and channel conditions. If the network is not congested, it accepts the request and grants the client the medium time for its traffic stream. Otherwise, it rejects the request. This enables the AP to maintain QoS when the WLAN becomes congested after a connection has already been established. Some clients contain sufficient intelligence to decide to either delay the traffic stream, associate with a different AP, or establish a best-effort traffic stream outside the operation of WMM-Admission Control. The default setting is **Off**. Note that the QoS priority of traffic queues is voice, video, best effort, background—this gives the highest priority to voice transmissions.
13. **WMM ACM Voice:** Click **On** to enable Wireless Multimedia Admission Control for voice calls. As for **WMM ACM Video** above, when admission control for voice is enabled, the AP evaluates a voice request from a client device against the network load and channel conditions. If the network is not congested, it accepts the request and grants the client the medium time for its call. Otherwise, it rejects the request. Some clients contain sufficient intelligence to decide to either delay the traffic stream, associate with a different AP, or establish a best-effort traffic stream outside the operation of WMM-Admission Control. The default setting is **Off**.

### Station Management

14. **Station Re-Authentication Period:** This specifies an interval (in seconds) for station reauthentications. This is the minimum time period between station authentication attempts, enforced by the AP. This feature is part of the [Riverbed Advanced RF Security Manager \(RSM\)](#).

15. **Station Timeout Period:** Specify a time (in seconds) in this field to define the timeout period for station associations.
16. **Max Station Association per Access Point:** This option allows you to define how many station associations are allowed per AP, or enter **unlimited**. Note that the **Max Station Association per IAP** limit (below) may not be exceeded, so entering **unlimited**, in practice, will stop at the per-IAP limit.
17. **Max Station Association per IAP:** This defines how many station associations are allowed per IAP. Note that the SSIDs > [SSID Management](#) window also has a station limit option—**Station Limit**, and the windows for [Global Settings .11an](#) and [Global Settings .11bgn](#) also have **Max Stations** settings. If multiple station limits are set, all will be enforced. As soon as any limit is reached, no new stations can associate until some other station has terminated its association.
18. **Block Inter-Station Traffic:** This option allows you to block or allow traffic between wireless clients that are associated to the AP. Choose either **Yes** (to block traffic) or **No** (to allow traffic).
19. **Allow Over Air Management:** Choose **Yes** to enable management of the AP via the IAPs, or choose **No** (recommended) to disable this feature.
20. **Extract Station Info:** By default, **Hostname**, **IP Address**, **NetBIOS Name**, and **User Agent String** are all requested when the AP obtains information from a station that is associated to it. For your convenience, this information is shown in various places such as [Station Status Windows](#) and in station displays in XMS. If you don't need all of this information, you may disable the fetching of some or all of these items. Use **All** to enable or disable all items in one step.
21. **DHCP Period:** The time (in seconds) that the DHCP assigned IP address is treated as authoritative, as the AP extracts the IP address from DHCP packets only during this period. Once the DHCP Period has expired, or is set to a value of zero, the AP will extract the IP address from any packet.

## Advanced Traffic Optimization

Advanced Traffic Optimization

**Multicast Processing:**

**Multicast Exclude:**

**Multicast Forwarding Addresses:**

**Multicast VLAN Forwarding:**

**MDNS Filter:**

Figure 169. Multicast Processing



*Multicast isolation CLI commands offer additional handling options for multicast traffic to stations. These commands will pass specified multicast traffic even if you are using Air Cleaner filters. See “interface” on page 477.*

- 22. Multicast Processing:** This sets how multicast traffic is handled. Multicast traffic can be received by a number of subscribing stations at the same time, thus saving a great deal of bandwidth. In some of the options below, the AP uses IGMP snooping to determine the stations that are subscribed to the multicast traffic. IGMP (Internet Group Management Protocol) is used to establish and manage the membership of multicast groups.

Multicast handling options are only applicable to traffic transmitted from the AP to wireless stations. Select one of the following options:

- **Send multicasts unmodified.** This is useful when multicast is not needed because no video or audio streaming is required or when it is used only for discovering services in the network. Some situations where you might use this option are:
  - for compatibility with ordinary operation, i.e., there is no optimization or modification of multicast traffic.
  - if you have an application where many subscribers need to see the multicast—a large enough number that it would be less efficient to convert to unicast and better just to send out multicast even though it must be sent out at the speed of the slowest connected station.

An example of a situation that might benefit from the use of this mode is ghosting all the laptops in a classroom using multicast. One multicast stream at, say, 6 Mbps is probably more efficient than thirty unicast streams.

The next three options convert multicast to unicast. Packets are sent directly to the stations at the best possible data rates. This approach significantly improves the quality of the voice and video multicast streams.

- **Convert to unicast and send unicast packets to all stations.** This may be useful in link-local multicast situations.
- **Convert to unicast, snoop IGMP, and only send to stations subscribed (send as multicast if no subscription).** This option is useful when you need to stream voice or video multicast traffic to all stations, but some stations are capable of subscribing to multicast groups while other stations are not. The stations that do not subscribe will not benefit from conversion to unicast; their video or voice quality may be compromised.
- **Convert to unicast, snoop IGMP, and only send to stations subscribed (don't send packet if no subscription).** This option is useful in well controlled environments when you need to stream voice or video multicast traffic only to stations that are capable of

subscribing to multicast groups and there is no need for the rest of the stations to receive the data stream.

- 23. Multicast Exclude:** This is a list of multicast IP addresses that will not be subject to multicast-to-unicast conversion. This list is useful on networks where applications such as those using multicast Domain Name System (mDNS) are in use. For example, Apple Bonjour finds local network devices such as printers or other computers using mDNS. By default, the list contains the IPv4 multicast address for Apple Bonjour mDNS: 224.0.0.251.

To add a new IP address to the list, type it in the top field and click the **Add** button to its right. You may only enter IP addresses—host names are not allowed. This is because mDNS is a link local multicast address, and does not require IGMP to the gateway.

To remove an entry, select it in the list and click **Delete**. To remove *all* entries from the list, click **Reset**.

#### **24. Multicast Forwarding**

Multicast Forwarding is a Riverbed feature that forwards selected multicast traffic between wired VLANs and wireless SSIDs. For example, Apple devices use mDNS to advertise and find services, using local network multicasts that are not routed. This creates an issue when you are using Apple devices on the Wireless LAN, and have other devices that provide services connected on the wired infrastructure in a different VLAN, for example, printers and AppleTV devices. One way to address this issue is to set up multicast forwarding between the wireless SSID and the wired VLAN. This requires the wired VLAN to be trunked to the AP. Once configured correctly, mDNS traffic will be forwarded from the specified wireless network(s) to the specified wired VLANs and vice-versa, subject to any mDNS service filtering defined ([Step 26](#)).



Use multicast forwarding together with multicast VLAN forwarding (Step 25) and mDNS filtering (Step 26) to make services available across VLANs as follows:

- In **Multicast Forwarding Addresses**, enter a list of multicast addresses that you want forwarded, for example, 224.0.0.251 (the multicast address for Bonjour).
- In **Multicast VLAN Forwarding**, enter a list of VLANs that participate in the multicast forwarding.
- In **MDNS Filter**, specify the mDNS service types that are allowed to be forwarded.
  - If you leave this field blank, then there is *no* filter, and *mDNS packets for all service types are passed*.
  - If you enter service types, then this acts as an allow filter, and *mDNS packets are passed only for the listed service types*.

Note that mDNS filtering may be used to filter the mDNS packet types that are forwarded within the same VLAN. Also, in conjunction with multicast forwarding, it may be used to filter the mDNS packet types that are forwarded across configured VLANs.

After you have entered these settings, when multicast packets arrive from the wired network from one of the **Multicast Forwarding Addresses** on any VLAN specified in **Multicast VLAN Forwarding**, they are forwarded to the corresponding wireless SSID for that VLAN.

Multicast packets coming in from the wireless network on an SSID tied to one of the specified VLANs and matching one of the **Multicast Forwarding Addresses** are forwarded to the specified VLANs on the wired network.

No modifications are made to the forwarded packets – they are just forwarded between specified VLANs and associated SSIDs.



*Riverbed strongly recommends the use of MDNS Filters (Step 26) when using multicast forwarding. Only allow required services to be forwarded.*

*Carefully monitor results, as forwarding may flood your network with multicast traffic. Experience has shown Bonjour devices to be very chatty. Also note that since this is link local multicast traffic, it will be sent to every wired port in the VLAN, as IGMP snooping does not work with link local multicast addresses.*

To specify **Multicast Forwarding Addresses**: enter each IP address in the top field and click the **Add** button to its right. You may only enter IPv4 multicast addresses - host names are not allowed. To remove an entry, select it in the list and click **Delete**. To remove *all* entries from the list, click **Reset**.

- 25. Multicast VLAN Forwarding:** This is a list of VLANs that participate in the multicast forwarding. Please see the description of multicast forwarding in [Step 24](#) above.



*The VLANs you enter must be explicitly defined (see “VLANs” on page 217) in order to participate in multicast forwarding. In fact, the AP discards packets from undefined VLANs.*

Multicast VLAN Forwarding operates as follows:

- If you leave this field blank, then there is *no* filter, and *Multicast Forwarding traffic is passed across all VLANs*.
- If you enter VLANs, then this acts as an allow filter, and *Multicast Forwarding traffic is passed **only** to the listed VLANs*.

To add a new VLAN to the list, enter its number or name in the top field and click the **Add** button to its right. You may enter multiple VLANs at once, separated by a space. To remove an entry, select it in the list and click **Delete**. To remove *all* entries from the list, click **Reset**.

These VLANs must be trunked to the AP from the LAN switch, and be defined on the AP. See “[VLAN Management](#)” on page 221 and “[SSID Management](#)” on page 283.



*Note that Multicast Forwarding and mDNS Filtering capabilities also work if both devices are wireless. For example, let's say that AppleTV is using wireless to connect to an SSID that is associated with VLAN 56, and the wireless client is on an SSID that is associated with VLAN 58. Normally the wireless client would not be able to use Bonjour to discover the AppleTV because they are on separate VLANs. But if you add 224.0.0.251 to the **Multicast Forwarding Addresses**, then add VLANs 56 and 58 to the **Multicast VLAN Forwarding** list, then the wireless client will be able to discover the AppleTV. In this same scenario you could add AppleTV to the **MDNS Filter** list so that only MDNS packets for the AppleTV service type would be forwarded between VLANs 56 and 58.*

*Note that all the VLANs that you add to this list do not have to be associated with SSIDs. As an example, say that AppleTV is on the wired network on VLAN 56, while the wireless device is connected to an SSID that is associated to VLAN 58. In this case, VLAN 56 and 58 need to be defined on the AP but only VLAN 58 needs to be associated to a SSID.*

- 26. MDNS Filter:** There are many different types of services that may be specified in multicast query and response packets. The mDNS filters let you restrict forwarding, so that multicast packets are forwarded only for the services that you explicitly specify. This list may be used to restrict the amount of Apple Bonjour multicast traffic forwarding. For example, you may restrict forwarding to just AppleTV and printing services. Please see the description of multicast forwarding in [Step 24](#) above.

The **MDNS Filter** operates as follows:

- If you leave this field blank, then there is **no** filter, and *mDNS packets for all service types are passed.*
- If you enter service types, then this acts as an allow filter, and *mDNS packets are passed **only** for the listed service types.*

To add an mDNS packet type to the list of packets that may be forwarded, select it from the drop-down list in the top field and click the **Add** button to its right. The drop-down list offers packet types such as **AirTunes**,

**Apple-TV, iChat, iPhoto, iTunes, iTunes-Home-Sharing, Internet-Printing, Mobile-Device-Sync, and Secure-Telnet.**

For example, to allow mirroring of an iPad on an Apple-TV, select **Apple-TV**.

You may define your own type if you do not see the service you want in the drop-down list. Simply enter the mDNS service name that you would like to allow through. Custom mDNS packet types must be prefixed with an underscore, e.g., **\_airvideosever**.

To remove an entry, select it in the list and click **Delete**. To remove *all* entries from the list, click **Reset**.

Broadcast Rates:  Optimized  Standard

Load Balancing:  Off  On

IPv6 Filtering:  Off  On

ARP Filtering:  Off  Pass-thru  Proxy

Xirrus Roaming Layer:  2 and 3  2 only

Xirrus Roaming Mode:  Off  Broadcast  Tunneled

Share Roaming Info With:  All  In Range  Target Only

Xirrus Roaming Targets:

Figure 170. Additional Optimization Settings

- 27. Broadcast Rates:** This changes the rates of broadcast traffic sent by the AP (not including management packets). When set to **Optimized**, each broadcast or multicast packet that is transmitted on each radio is sent at the highest common rate to any client associated to that radio at that time. This results in each IAP broadcasting at the highest AP Tx data rate that can be heard by all associated stations, improving system performance. The rate is determined dynamically to ensure the best broadcast/multicast performance possible. Consider a properly designed network

(having -70db or better everywhere), where virtually every client should have a 54Mbps connection. In this case, broadcasts and multicasts will all go out at 54Mbps vs. the standard rate. Thus, with broadcast rate optimization on, broadcasts and multicasts use between 2% and 10% of the bandwidth that they would in Standard mode.

When set to **Standard** (the default), broadcasts are sent out at the lowest basic rate only—6 Mbps for 5GHz clients, or 1 Mbps for 2.4GHz clients. The option you select here is applied to all IAPs.

- 28. Load Balancing (ACExpress™):** Wi-Fi is a shared medium and only one device can transmit data at any time. Faster devices supporting 802.11ac standards have to wait until the slower devices finish transmitting data. This brings down the overall throughput of the network. For example, an 802.11n client operates more than four times slower than an 802.11ac client, and thus will take four times more air time to communicate a given amount of data. This starves the available bandwidth from faster clients, reducing performance significantly. Riverbed solves this issue with ACExpress that automatically separates devices onto different IAPs by their speeds and capability.

ACExpress identifies station capabilities based on fingerprinting and automatically groups devices by performance. It works on all modes (802.11a/b/g/n/ac) and bands (2.4GHz and 5GHz). This results in improved performance for every WLAN client and optimized use of wireless radio resources. Factors including wireless band, number of spatial streams, 802.11ac and 802.11n capability, and signal to noise ratio are considered.

This feature also provides automatic load balancing designed to distribute wireless stations across multiple radios rather than having stations associate to the closest radios with the strongest signal strength, as they normally would. In wireless networks, the station selects the radio to which it will associate. The AP cannot actually force load balancing, however it can “encourage” stations to associate in a more optimal fashion to underused radios of the most advantageous type. This option enables or disables active load balancing between the AP IAPs.

If you select **On** and an IAP is not the best choice for network performance, that IAP will send an “AP Full” message in response to Probe, Association, or Authentication requests. This deters persistent clients from forcing their way onto overloaded IAPs.

Note that ACEXpress load balancing is **not** used if:

- A station is re-associating—if it was already associated to this IAP, it is allowed back on this IAP immediately. This prevents the station from being bounced between different IAPs.
- The IAP’s **Band**, **WiFi Mode**, and **Channel** settings are not at their default values. For example, if the IAP’s WiFi mode is set to 11n-only, load balancing will not be used. See “[IAP Settings](#)” on page 319.
- If station counts (specified at the IAP, SSID, or band level) are already exceeded.
- If a station has already been turned down a number of times when attempting to associate, i.e., the station will eventually be allowed onto the IAP after a number of attempts have failed.

Choose **Off** to disable load balancing.

29. **ARP Filtering:** Address Resolution Protocol finds the MAC address of a device with a given IP address by sending out a broadcast message requesting this information. ARP filtering allows you to reduce the proliferation of ARP messages by restricting how they are forwarded across the network.

You may select from the following options for handling ARP requests:

- **Off:** ARP filtering is disabled. ARP requests are broadcast to radios that have stations associated to them.
- **Pass-thru:** The AP forwards the ARP request. It passes along only ARP messages that target the stations that are associated to it. This is the default value.
- **Proxy:** The AP replies on behalf of the stations that are associated to it. The ARP request is not broadcast to the stations.

Note that the AP has a broadcast optimization feature that is always on (it is not configurable). Broadcast optimization restricts all broadcast packets (not just ARP broadcasts) to only those radios that need to forward them. For instance, if a broadcast comes in from VLAN 10, and there are no VLAN 10 users on a radio, then that radio will not send out that broadcast. This increases available air time for other traffic.

30. **IPv6 Filtering:** this setting allows blocking of IPv6 traffic which may be a concern for IT managers. The Riverbed AP currently bridges IPv6 traffic. Set IPv6 filtering **On** if you wish to prevent the forwarding of IPv6 packets through the AP in both directions—wired network to wireless and wireless network to wired. The default is **Off**.
31. **Riverbed Roaming Layer:** Select whether to enable roaming capabilities between IAPs or APs at Layer **2 and 3**, or at Layer **2 only**. Depending on your wired network, you may wish to allow fast roaming at Layer 3. This may result in delayed traffic.
32. **Riverbed Roaming Mode:** This feature utilizes the Riverbed Roaming Protocol (RP) ensuring fast and seamless roaming capabilities between IAPs or APs at Layer 2 and Layer 3 (as specified in [Step 33](#)), while maintaining security. Fast roaming eliminates long delays for re-authentication, thus supporting time-sensitive applications such as Voice over Wi-Fi (see [“Understanding Fast Roaming”](#) on page 318 for a discussion of this feature). RP uses a discovery process to identify other Riverbed APs as fast roaming targets. This process has two modes:
  - **Broadcast**—the AP uses a broadcast technique to discover other APs that may be targets for fast roaming.
  - **Tunneled**—in this Layer 3 technique, fast roaming target APs must be explicitly specified.

To enable fast roaming, choose **Broadcast** or **Tunneled**, and set additional fast roaming attributes ([Step 33](#)). To disable fast roaming, choose **Off**. If you enable Fast Roaming, the following ports **cannot** be blocked:

- **Port 22610**—reserved for Layer 2 roaming using UDP to share PMK information between APs.

- **Ports 15000 to 17999**—reserved for Layer 3 roaming (tunneling between subnets).
33. **Share Roaming Info With:** Three options allow your AP to share roaming information with all APs; just with those that are within range; or with specifically targeted APs. Choose either **All**, **In Range** or **Target Only**, respectively.
- a. **Riverbed Roaming Targets:** If you chose **Target Only**, use this option to add target MAC addresses. Enter the MAC address of each target AP, then click on **Add** (add as many targets as you like). To find a target's MAC address, open the **AP Info** window on the target AP and look for **IAP MAC Range**, then use the starting address of this range.

To delete a target, select it from the list, then click **Delete**.

*See Also*

Coverage and Capacity Planning

Global Settings .11ac

Global Settings .11an

Global Settings .11bgn

Global Settings .11n

Advanced RF Settings

IAPs

IAP Statistics Summary

LED Settings

IAP Settings



## Global Settings .11an

This window allows you to establish global 802.11a IAP settings. These settings include defining which 802.11a data rates are supported, enabling or disabling all 802.11an IAPs, auto-configuration of channel allocations for all 802.11an IAPs, and specifying the fragmentation and RTS thresholds for all 802.11an IAPs.

802.11a Data Rates:	6.0	<input checked="" type="checkbox"/> Supported	<input checked="" type="checkbox"/> Basic
	9.0	<input checked="" type="checkbox"/> Supported	<input type="checkbox"/> Basic
	12.0	<input checked="" type="checkbox"/> Supported	<input checked="" type="checkbox"/> Basic
	18.0	<input checked="" type="checkbox"/> Supported	<input type="checkbox"/> Basic
	24.0	<input checked="" type="checkbox"/> Supported	<input checked="" type="checkbox"/> Basic
	36.0	<input checked="" type="checkbox"/> Supported	<input type="checkbox"/> Basic
	48.0	<input checked="" type="checkbox"/> Supported	<input type="checkbox"/> Basic
	54.0	<input checked="" type="checkbox"/> Supported	<input type="checkbox"/> Basic
Data Rate Presets:	<input type="button" value="Optimize Range"/> <input type="button" value="Optimize Throughput"/> <input type="button" value="Restore Defaults"/>		
802.11a IAP Control:	<input type="button" value="Enable All 802.11a IAPs"/> <input type="button" value="Disable All 802.11a IAPs"/>		
Channel Configuration:	<input type="button" value="Factory Defaults"/> <input type="button" value="Auto Configure"/> Options: <input type="checkbox"/> Negotiate <input type="checkbox"/> Full Scan		
Set Cell Size:	<input type="checkbox"/> Non-Radar <input type="checkbox"/> Include WDS		
Auto Cell By Channel:	<input type="button" value="Small"/> <input type="button" value="Medium"/> <input type="button" value="Large"/> <input type="button" value="Max"/> <input type="button" value="Auto"/>		
Auto Cell Period (seconds):	<input checked="" type="checkbox"/> On <input type="checkbox"/> None		
Auto Cell Size Overlap (%):	<input type="text" value="50"/>		
Auto Cell Min Cell Size:	<input type="button" value="Default"/> <input type="button" value="Small"/> <input type="button" value="Medium"/> <input type="button" value="Large"/>		
Auto Cell Min Tx Power (dBm):	<input type="text" value="10"/> <input type="button" value="Set Default"/>		
Auto Cell Max Rx Threshold (dBm):	<input type="text" value="-80"/> <input type="button" value="Set Default"/>		
Auto Cell Configuration:	<input type="button" value="Auto Configure"/>		
Fragmentation Threshold (256-2346):	<input type="text" value="2346"/>		
RTS Threshold (1-2347):	<input type="text" value="2347"/>		
Max Stations (1-240):	<input type="text" value="64"/>		

Figure 171. Global Settings .11an

### Procedure for Configuring Global 802.11an IAP Settings

- 802.11a Data Rates:** The AP allows you to define which data rates are supported for all 802.11an radios. Select (or deselect) data rates by clicking in the corresponding **Supported** and **Basic** data rate check boxes.
  - Basic Rate**—a wireless station (client) must support this rate in order to associate.
  - Supported Rate**—data rates that can be used to transmit to clients.

2. **Data Rate Presets:** The Wireless AP can optimize your 802.11a data rates automatically, based on range or throughput. Click **Optimize Range** to optimize data rates based on range, or click **Optimize Throughput** to optimize data rates based on throughput. The **Restore Defaults** button will take you back to the factory default rate settings.
3. **802.11a IAP Control:** Click **Enable 802.11a IAPs** to enable all 802.11a IAPs for this AP, or click **Disable 802.11a IAPs** to disable all 802.11a IAPs.
4. **Channel Configuration:** Click **Auto Configure** to instruct the AP to determine the best channel allocation settings for each 802.11a IAP and select the channel automatically, based on changes in the environment. This is the recommended method for 802.11a channel allocation (see “[RF Spectrum Management](#)” on page 368).

Click **Factory Defaults** if you wish to instruct the AP to return all IAPs to their factory preset channels. As of release 6.3, APs no longer all use the same factory preset values for channel assignments. Instead, if the AP has been deployed for a while and already has data from the spectrum analyzer and Riverbed Roaming Protocol about channel usage on neighboring APs, it performs a quick auto channel using that information (without doing a full RF scan) to make an intelligent choice of channel assignments. If the AP has been rebooted and has no saved configuration or is just being deployed for the first time, it has no prior data about its RF environment. In this case, it will pick a set of compatible channel assignments at random.



*On the XR-500/600 and XR-1000 Series models, the **Factory Defaults** button will not restore iap1 to monitor mode. You will need to restore this setting manually. Also, you may need to set **Timeshare Mode** again - see “[RF Monitor](#)” on page 365.*

The following options may be selected for auto configuration:

- **Non-Radar:** give preference to channels that are not required to use dynamic frequency selection (DFS) to avoid communicating in the same frequency range as some radar (also see [Step 8 on page 327](#)).

Channels Required to Use DFS Radar Avoidance in USA			
36+40	Non-radar	116	DFS required
44+48	Non-radar	132+136	DFS required
52+56	DFS required	140+144	DFS required
60+64	DFS required	149+153	Non-radar
100+104	DFS required	157+161	Non-radar
108+112	DFS required	165	Non-radar

Channels Required to Use DFS Radar Avoidance in Europe			
36+40	Non-radar	116+120*	DFS required
44+48	Non-radar	124*+128*	DFS required
52+56	DFS required	132+136	DFS required
60+64	DFS required	140+144	DFS required
100+104	DFS required	149+153	Non-radar
108+112	DFS required	157+161	Non-radar
* Channels 120, 124, 128 use a 10 minute Channel Availability Check (CAC) time in Europe		165	Non-radar

- **Negotiate:** negotiate air-time with other APs before performing a full scan.

- **Full Scan:** perform a full traffic scan on all channels on all IAPs to determine the best channel allocation.
- **Include WDS:** automatically assign 5GHz to WDS client links.



*To use the Auto Cell Size feature, any IAPs that will use Auto Cell must have **Cell Size** set to **auto**.*

*For Auto Cell by Channel, it is not necessary for RF Monitor Mode to be turned on, or for there to be a radio set to monitor mode. For Auto Cell by Band, RF Monitor Mode must be set to Dedicated or Timeshare mode, and there must be a radio set to monitor mode. See “**RF Monitor**” on page 365.*

5. **Set Cell Size:** Cell Size may be set globally for all 802.11an IAPs to **Auto**, **Large**, **Medium**, **Small**, or **Max** using the buttons.

For an overview of RF power and cell size settings, please see “**RF Power and Sensitivity**” on page 367, “**Capacity and Cell Sizes**” on page 40, and “**Fine Tuning Cell Sizes**” on page 41.

6. **Auto Cell By Channel:** By default, this feature is **On**, and auto cell will adjust the cell size for a radio when nearby APs have radios on the same channel within earshot of each other, so that the two radios minimize interference with each other. If this option is unchecked, then auto cell will adjust the cell size for a radio when nearby APs have radios on the same band, even if they are using different channels (called Auto Cell by Band, or Multichannel Auto Cell). This will result in smaller cell sizes. See “**Fine Tuning Cell Sizes**” on page 41.
7. **Auto Cell Period (seconds):** You may set up auto-configuration to run periodically, readjusting optimal cell sizes for the current conditions. Enter a number of seconds to specify how often auto-configuration will run. If you select **None**, then auto-configuration of cell sizing will not be run periodically. You do not need to run Auto Cell often unless there are a lot of changes in the environment. If the RF environment is changing often, running Auto Cell every twenty-four hours (86400 seconds) should be sufficient). The default value is **None**.

8. **Auto Cell Size Overlap (%)**: Enter the percentage of cell overlap that will be allowed when the AP is determining automatic cell sizes. For 100% overlap, the power is adjusted such that neighboring APs that hear each other best will hear each other at -70dB. For 0% overlap, that number is -90dB. The default value is 50%.
9. **Auto Cell Min Cell Size**: Use this setting if you wish to set the minimum cell size that Auto Cell may assign. The values are **Default**, **Large**, **Medium**, or **Small**.
10. **Auto Cell Min Tx Power (dBm)**: Enter the minimum transmit power that the AP can assign to a radio when adjusting automatic cell sizes. The default value is 10.
11. **Auto Cell Max Rx Threshold (dBm)**: Enter the maximum receive threshold that the AP can assign to a radio when adjusting automatic cell sizes. The default value is -80.
12. **Auto Cell Configuration**: Click this button to instruct the AP to determine and set the best cell size for each 802.11an IAP whose **Cell Size** is **auto** on the [IAP Settings](#) window, based on changes in the environment. This is the recommended method for setting cell size. You may look at the Tx and Rx values on the [IAP Settings](#) window to view the cell size settings that were applied.
13. **Fragmentation Threshold**: This is the maximum size for directed data [packets](#) transmitted over the 802.11an radio. Larger frames fragment into several packets, their maximum size defined by the value you enter here. Smaller fragmentation numbers can help to “squeeze” packets through in noisy environments. Enter the desired **Fragmentation Threshold** value in this field, between 256 and 2346.
14. **RTS Threshold**: The Request To Send (RTS) Threshold specifies the [packet](#) size. Packets larger than the RTS threshold will use CTS/RTS prior to transmitting the packet—useful for larger packets to help ensure the success of their transmission. Enter a value between 1 and 2347.
15. **Max Stations**: This defines how many station associations are allowed per 802.11an IAP. Note that the IAPs > Global Settings window and

SSIDs—SSID Management window also have station limit settings—**Max Station Association per IAP** (page 329) and **Station Limit** (page 290), respectively. If multiple station limits are set, all will be enforced. As soon as any limit is reached, no new stations can associate until some other station has terminated its association.

*See Also*

[Coverage and Capacity Planning](#)

[Global Settings](#)

[Global Settings .11bgn](#)

[Global Settings .11n](#)

[IAPs](#)

[IAP Statistics Summary](#)

[Advanced RF Settings](#)

[IAP Settings](#)

## Global Settings .11bgn

This window allows you to establish global 802.11b/g IAP settings. These settings include defining which 802.11b and 802.11g data rates are supported, enabling or disabling all 802.11b/g IAPs, auto-configuring 802.11b/g IAP channel allocations, and specifying the fragmentation and RTS thresholds for all 802.11b/g IAPs.

802.11g Data Rates:	6.0	<input checked="" type="checkbox"/> Supported	<input type="checkbox"/> Basic
	9.0	<input checked="" type="checkbox"/> Supported	<input type="checkbox"/> Basic
	12.0	<input checked="" type="checkbox"/> Supported	<input type="checkbox"/> Basic
	18.0	<input checked="" type="checkbox"/> Supported	<input type="checkbox"/> Basic
	24.0	<input checked="" type="checkbox"/> Supported	<input type="checkbox"/> Basic
	36.0	<input checked="" type="checkbox"/> Supported	<input type="checkbox"/> Basic
	48.0	<input checked="" type="checkbox"/> Supported	<input type="checkbox"/> Basic
	54.0	<input checked="" type="checkbox"/> Supported	<input type="checkbox"/> Basic
802.11b Data Rates:	1.0	<input checked="" type="checkbox"/> Supported	<input checked="" type="checkbox"/> Basic
	2.0	<input checked="" type="checkbox"/> Supported	<input checked="" type="checkbox"/> Basic
	5.5	<input checked="" type="checkbox"/> Supported	<input checked="" type="checkbox"/> Basic
	11.0	<input checked="" type="checkbox"/> Supported	<input checked="" type="checkbox"/> Basic

Data Rate Presets:

802.11b/g IAP Control:

Channel Configuration:

Set Cell Size:

Auto Cell By Channel:

Auto Cell Period (seconds):

Auto Cell Size Overlap (%):

Auto Cell Min Cell Size:

Auto Cell Min Tx Power (dBm):

Auto Cell Max Rx Threshold (dBm):

Auto Cell Configuration:

802.11g Only:

802.11g Protection:

802.11g Slot:

802.11b Preamble:

Fragmentation Threshold (256-2346):

RTS Threshold (1-2347):

Max Stations (1-240):

Options:  Negotiate  Full S

Buttons: Optimize Range, Optimize Throughput, Restore Defaults, Enable All 802.11b/g IAPs, Disable All 802.11b/g IAPs, Factory Defaults, Auto Configure, Small, Medium, Large, Max, Auto, Default, Set Default, Auto Configure, On, None, Auto CTS, Auto RTS, Off, Short Only, Long Only.

Figure 172. Global Settings .11bgn

---

*Procedure for Configuring Global 802.11b/g IAP Settings*

1. **802.11g Data Rates:** The AP allows you to define which data rates are supported for all 802.11g radios. Select (or deselect) 11g data rates by clicking in the corresponding **Supported** and **Basic** data rate check boxes.
  - **Basic Rate**—a wireless station (client) must support this rate in order to associate.
  - **Supported Rate**—data rates that can be used to transmit to clients.
2. **802.11b Data Rates:** This task is similar to Step 1, but these data rates apply only to 802.11b IAPs.
3. **Data Rate Presets:** The Wireless AP can optimize your 802.11b/g data rates automatically, based on range or throughput. Click **Optimize Range** button to optimize data rates based on range, or click on the **Optimize Throughput** to optimize data rates based on throughput. **Restore Defaults** will take you back to the factory default rate settings.
4. **802.11b/g IAP Control:** Click **Enable All 802.11b/g IAPs** to enable all 802.11b/g IAPs for this AP, or click **Disable All 802.11b/g IAPs** to disable them.
5. **Channel Configuration:** Click **Auto Configure** to instruct the AP to determine the best channel allocation settings for each 802.11b/g IAP and select the channel automatically, based on changes in the environment. This is the recommended method for channel allocation (see [“RF Spectrum Management” on page 368](#)).

Click **Factory Defaults** if you wish to instruct the AP to return all IAPs to their factory preset channels. As of release 6.3, APs no longer all use the same factory preset values for channel assignments. Instead, if the AP has been deployed for a while and already has data from the spectrum analyzer and Riverbed Roaming Protocol about channel usage on neighboring APs, it performs a quick auto channel using that information (without doing a full RF scan) to make an intelligent choice of channel assignments. If the AP has been rebooted and has no saved configuration or is just being deployed for the first time, it has no prior data about its RF



environment. In this case, it will pick a set of compatible channel assignments at random.



*On the XR-500/600 and XR-1000 Series, the **Factory Defaults** button will not restore `iap1` to monitor mode. You will need to restore this setting manually. Also, you may need to set **Timeshare Mode** again - see “RF Monitor” on page 365.*

The following options may be selected for auto configuration:

- **Negotiate:** negotiate air-time with other APs before performing a full scan.
  - **Full Scan:** perform a full traffic scan on all channels on all IAPs to determine the best channel allocation.
  - **Non-Radar:** give preference to channels without radar-detect. See table in “Procedure for Configuring Global 802.11an IAP Settings” on page 341.
  - **Include WDS:** automatically assign 5GHz to WDS client links.
6. **Set Cell Size/ Autoconfigure:** Cell Size may be set globally for all 802.11b/g IAPs to **auto**, **large**, **medium**, **small**, or **max** using the drop down menu.

For an overview of RF power and cell size settings, please see “RF Power and Sensitivity” on page 367, “Capacity and Cell Sizes” on page 40, and “Fine Tuning Cell Sizes” on page 41.

7. **Auto Cell By Channel:** By default, this feature is **On**, and auto cell will adjust the cell size for a radio when nearby APs have radios on the same channel within earshot of each other, so that the two radios minimize interference with each other. If this option is unchecked, then auto cell will adjust the cell size for a radio when nearby APs have radios on the same band, even if they are using different channels (called Auto Cell by Band, or Multichannel Auto Cell). This will result in smaller cell sizes. See “Fine Tuning Cell Sizes” on page 41.



To use the Auto Cell Size feature, any IAPs that will use Auto Cell must have **Cell Size** set to **auto**.

For **Auto Cell by Channel**, it is not necessary for RF Monitor Mode to be turned on, or for there to be a radio set to monitor mode. For **Auto Cell by Band**, RF Monitor Mode must be set to **Dedicated** or **Timeshare** mode, and there must be a radio set to monitor mode. See “RF Monitor” on page 365.

8. **Auto Cell Period (seconds):** You may set up auto-configuration to run periodically, readjusting optimal cell sizes for the current conditions. Enter a number of seconds to specify how often auto-configuration will run. If you select **None**, then auto-configuration of cell sizing will not be run periodically. You do not need to run Auto Cell often unless there are a lot of changes in the environment. If the RF environment is changing often, running Auto Cell every twenty-four hours (86400 seconds) should be sufficient. The default value is **None**.
9. **Auto Cell Size Overlap (%):** Enter the percentage of cell overlap that will be allowed when the AP is determining automatic cell sizes. For 100% overlap, the power is adjusted such that neighboring APs that hear each other best will hear each other at -70dB. For 0% overlap, that number is -90dB. The default value is **50%**.
10. **Auto Cell Min Cell Size:** Use this setting if you wish to set the minimum cell size that Auto Cell may assign. The values are **Default**, **Large**, **Medium**, or **Small**.
11. **Auto Cell Min Tx Power (dBm):** Enter the minimum transmit power that the AP can assign to a radio when adjusting automatic cell sizes. The default value is **10**.
12. **Auto Cell Max Rx Threshold (dBm):** Enter the maximum receive threshold that the AP can assign to a radio when adjusting automatic cell sizes. The default value is **-80**.

13. **Auto Cell Configuration:** Click **Auto Configure** to instruct the AP to determine and set the best cell size for each enabled 802.11b/g IAP whose **Cell Size** is **auto** on the **IAP Settings** window, based on changes in the environment. This is the recommended method for setting cell size. You may look at the Tx and Rx values on the **IAP Settings** window to view the cell size settings that were applied.
14. **802.11g Only:** Choose **On** to restrict use to 802.11g mode only. In this mode, no 802.11b rates are transmitted. Stations that only support 802.11b will not be able to associate.
15. **802.11g Protection:** You should select **Auto CTS** or **Auto RTS** to provide automatic protection for all 802.11g radios in mixed networks (802.11b and g). You may select **Off** to disable this feature, but this is not recommended. Protection allows 802.11g stations to share the IAP with older, slower 802.11b stations. Protection avoids collisions by preventing 802.11b and 802.11g stations from transmitting simultaneously. When **Auto CTS** or **Auto RTS** is enabled and any 802.11b station is associated to the IAP, additional frames are sent to gain access to the wireless network.
  - Auto CTS requires 802.11g stations to send a slow Clear To Send frame that locks out other stations. Automatic protection reduces 802.11g throughput when 802.11b stations are present—Auto CTS adds less overhead than Auto RTS. The default value is Auto CTS.
  - With Auto RTS, 802.11g stations reserve the wireless media using a Request To Send/Clear To Send cycle. This mode is useful when you have dispersed nodes. It was originally used in 802.11b only networks to avoid collisions from “hidden nodes”—nodes that are so widely dispersed that they can hear the AP, but not each other.

When there are no 11b stations associated and an auto-protection mode is enabled, the AP will not send the extra frames, thus avoiding unnecessary overhead.

16. **802.11g Slot:** Choose **Auto** to instruct the AP to manage the 802.11g slot times automatically, or choose **Short Only**. Riverbed recommends using **Auto** for this setting, especially if 802.11b devices are present.

17. **802.11b Preamble:** The [preamble](#) contains information that the AP and client devices need when sending and receiving packets. All compliant 802.11b systems have to support the long preamble. A short preamble improves the efficiency of a network's throughput when transmitting special data, such as voice, VoIP (Voice-over IP) and streaming video. Select **Auto** to instruct the AP to manage the preamble (long and short) automatically, or choose **Long Only**.
18. **Fragmentation Threshold:** This is the maximum size for directed data [packets](#) transmitted over the 802.11b/g IAP. Larger frames fragment into several packets, their maximum size defined by the value you enter here. Enter the desired **Fragmentation Threshold** value, between 256 and 2346.
19. **RTS Threshold:** The RTS (Request To Send) Threshold specifies the [packet](#) size. Packets larger than the RTS threshold will use CTS/RTS prior to transmitting the packet—useful for larger packets to help ensure the success of their transmission. Enter a value between 1 and 2347.
20. **Max Stations:** This defines how many station associations are allowed per 802.11bgn IAP. Note that the IAPs > Global Settings window and SSIDs > SSID Management window also have station limit settings—**Max Station Association per IAP** ([page 329](#)) and **Station Limit** ([page 290](#)), respectively. If multiple station limits are set, all will be enforced. As soon as any limit is reached, no new stations can associate until some other station has terminated its association.

*See Also*

[Coverage and Capacity Planning](#)

[Global Settings](#)

[Global Settings .11a](#)

[Global Settings .11n](#)

[Advanced RF Settings](#)

[LED Settings](#)

[IAP Settings](#)

[IAP Statistics Summary](#)

### Global Settings .11n

This window allows you to establish global 802.11n IAP settings. These settings include enabling or disabling 802.11n mode for the entire AP, specifying the number of transmit and receive chains (data stream) used for spatial multiplexing, setting a short or standard guard interval, auto-configuring channel bonding, and specifying whether auto-configured channel bonding will be static or dynamic.

Before changing your settings for 802.11n, please read the discussion in “About IEEE 802.11ac” on page 46.

Logged in as: admin ✖

	Spatial Streams	Modulation & Coding	Standard Rate	Bonded Rate	Bonded short GI Rate	Supported	Basic
802.11n Data Rates:	1	MCS0	6.5	13.5	15.0	<input checked="" type="checkbox"/>	<input type="checkbox"/>
		MCS1	13.0	27.0	30.0	<input checked="" type="checkbox"/>	<input type="checkbox"/>
		MCS2	19.5	40.5	45.0	<input checked="" type="checkbox"/>	<input type="checkbox"/>
		MCS3	26.0	54.0	60.0	<input checked="" type="checkbox"/>	<input type="checkbox"/>
		MCS4	39.0	81.0	90.0	<input checked="" type="checkbox"/>	<input type="checkbox"/>
		MCS5	52.0	108.0	120.0	<input checked="" type="checkbox"/>	<input type="checkbox"/>
		MCS6	58.5	121.5	135.0	<input checked="" type="checkbox"/>	<input type="checkbox"/>
	2	MCS7	65.0	135.0	150.0	<input checked="" type="checkbox"/>	<input type="checkbox"/>
		MCS8	13.0	27.0	30.0	<input checked="" type="checkbox"/>	<input type="checkbox"/>
		MCS9	26.0	54.0	60.0	<input checked="" type="checkbox"/>	<input type="checkbox"/>
		MCS10	39.0	81.0	90.0	<input checked="" type="checkbox"/>	<input type="checkbox"/>
		MCS11	52.0	108.0	120.0	<input checked="" type="checkbox"/>	<input type="checkbox"/>
		MCS12	78.0	162.0	180.0	<input checked="" type="checkbox"/>	<input type="checkbox"/>
		MCS13	104.0	216.0	240.0	<input checked="" type="checkbox"/>	<input type="checkbox"/>
	3	MCS14	117.0	243.0	270.0	<input checked="" type="checkbox"/>	<input type="checkbox"/>
		MCS15	130.0	270.0	300.0	<input checked="" type="checkbox"/>	<input type="checkbox"/>
		MCS16	19.5	40.5	45.0	<input checked="" type="checkbox"/>	<input type="checkbox"/>
		MCS17	39.0	81.0	90.0	<input checked="" type="checkbox"/>	<input type="checkbox"/>
		MCS18	58.5	121.5	135.0	<input checked="" type="checkbox"/>	<input type="checkbox"/>
		MCS19	78.0	162.0	180.0	<input checked="" type="checkbox"/>	<input type="checkbox"/>
		MCS20	117.0	243.0	270.0	<input checked="" type="checkbox"/>	<input type="checkbox"/>
		MCS21	156.0	324.0	360.0	<input checked="" type="checkbox"/>	<input type="checkbox"/>
		MCS22	175.5	364.5	405.0	<input checked="" type="checkbox"/>	<input type="checkbox"/>
MCS23		195.0	405.0	450.0	<input checked="" type="checkbox"/>	<input type="checkbox"/>	

802.11n Mode:  Enabled  Disabled

TX Chains:  1  2  3

RX Chains:  1  2  3

Guard interval:  Short  Long

Auto bond 5GHz channels:  Enabled  Disabled

5 GHz channel bonding:  Dynamic  Static

2.4 GHz channel bonding:  Dynamic  Static

Global channel bonding: Enable bonding on all IAPs Disable bonding on all IAPs

Figure 173. Global Settings .11n

---

### *Procedure for Configuring Global 802.11n IAP Settings*

1. **802.11n Data Rates:** The AP allows you to define which data rates are supported for all 802.11n radios. Select (or deselect) 11n data rates by clicking in the corresponding **Supported** and **Basic** data rate check boxes.
  - **Basic Rate**—a wireless station (client) must support this rate in order to associate.
  - **Supported Rate**—data rates that can be used to transmit to clients.
2. **802.11n Mode:** Select **Enabled** to allow the AP to operate in 802.11n mode.

If you select **Disabled**, then 802.11n operation is disabled on the AP.

3. **TX Chains:** Select the number of separate data streams transmitted by the antennas of each IAP. The maximum number of chains is determined by whether the AP has 2x2 or 3x3 radios. The default value is always the maximum supported by the radio type. See [“Up to Eight Simultaneous Data Streams—Spatial Multiplexing”](#) on page 48.
4. **RX Chains:** Select the number of separate data streams received by the antennas of each IAP. This number should be greater than or equal to **TX Chains**. The maximum number of chains is determined by whether the AP has 2x2 or 3x3 radios. The default value is always the maximum supported by the radio type. See [“Up to Eight Simultaneous Data Streams—Spatial Multiplexing”](#) on page 48.
5. **Guard interval:** Select **Short** to increase the data transmission rate by decreasing wait intervals in signal transmission. Select **Long** to use the standard interval. The default is Short.
6. **Auto bond 5 GHz channels:** Select **Enabled** to use Channel Bonding on 5 GHz channels and automatically select the best channels for bonding. The default is **Enabled**. See [“Higher Channel Widths \(Bonding\)”](#) on page 52.

7. **5 GHz Channel Bonding:** Select **Dynamic** to have auto-configuration for bonded 5 GHz channels be automatically updated as conditions change. For example, if there are too many clients to be supported by a bonded channel, dynamic mode will automatically break the bonded channel into two channels. Select **Static** to have the bonded channels remain the same once they are selected. The Dynamic option is only available when **Auto bond 5 GHz channels** is enabled. The default is **Dynamic**. See [“Higher Channel Widths \(Bonding\)” on page 52](#).
8. **2.4 GHz Channel Bonding:** Select **Dynamic** to have auto-configuration for bonded 2.4 GHz channels be automatically updated as conditions change. Select **Static** to have the bonded channels remain the same once they are selected. The default is **Dynamic**. See [“Higher Channel Widths \(Bonding\)” on page 52](#).
9. **Global channel bonding:** These buttons allow you to turn channel bonding on or off for all IAPs in one step. The effect of using one of these buttons will be shown if you go to the **IAP Settings** window and look at the **Bond** column. Clicking **Enable bonding on all IAPs** causes all IAPs to be bonded to their auto bonding channel immediately, if appropriate. For example, the IAP will not be bonded if it is set to monitor mode, and 2.4 GHz radios will not be bonded. Click **Disable bonding on all IAPs** to turn off bonding on all IAPs immediately. See [“Higher Channel Widths \(Bonding\)” on page 52](#). Settings in [Step 7](#) and [Step 8](#) are independent of global channel bonding.

### Global Settings .11ac

This window allows you to establish global 802.11ac IAP settings. These settings include enabling or disabling 802.11ac mode for the entire AP, specifying the number of data streams used in spatial multiplexing, and setting a short or long guard interval.

Before changing your settings for 802.11ac, please read the discussion in “About IEEE 802.11ac” on page 46.

**802.11ac Mode:**  Enabled  Disabled

**80 MHz Guard Interval:**  Short  Long

**Multi-User MIMO:**  Enabled  Disabled

**TX Beam Forming:**  Enabled  Disabled

**Max MCS - 1 Spatial Stream:** MCS9

**Max MCS - 2 Spatial Streams:** MCS9

**Max MCS - 3 Spatial Streams:** MCS9

**Max MCS - 4 Spatial Streams:** MCS9

802.11ac Supported Rates													
One Spatial Stream													
802.11ac Modulation & Coding Schema				MC50	MC51	MC52	MC53	MC54	MC55	MC56	MC57	MC58	MC59
Frequency	Type	Guard	Rate										
20MHz	channel	long	GI	6.5	13.0	19.5	26.0	39.0	52.0	58.5	65.0	78.0	-
20MHz	channel	short	GI	7.2	14.4	21.7	28.9	43.3	57.8	65.0	72.2	86.7	-
40MHz	bonded	long	GI	13.5	27.0	40.5	54.0	81.0	108.0	121.5	135.0	162.0	180.0
40MHz	bonded	short	GI	15.0	30.0	45.0	60.0	90.0	120.0	135.0	150.0	180.0	200.0
80MHz	bonded	long	GI	29.3	58.5	87.8	117.0	175.5	234.0	263.3	292.5	351.0	390.0
80MHz	bonded	short	GI	32.5	65.0	97.5	130.0	195.0	260.0	292.5	325.0	390.0	433.3
160MHz	bonded	long	GI	58.5	117.0	175.5	234.0	351.0	468.0	526.5	585.0	702.0	780.0
160MHz	bonded	short	GI	65.0	130.0	195.0	260.0	390.0	520.0	585.0	650.0	780.0	866.7

Two Spatial Streams													
802.11ac Modulation & Coding Schema				MC50	MC51	MC52	MC53	MC54	MC55	MC56	MC57	MC58	MC59
Frequency	Type	Guard	Rate										
20MHz	channel	long	GI	13.0	26.0	39.0	52.0	78.0	104.0	117.0	130.0	156.0	-
20MHz	channel	short	GI	14.4	28.9	43.3	57.8	86.7	115.6	130.0	144.4	173.3	-
40MHz	bonded	long	GI	27.0	54.0	81.0	108.0	162.0	216.0	243.0	270.0	324.0	360.0
40MHz	bonded	short	GI	30.0	60.0	90.0	120.0	180.0	240.0	270.0	300.0	360.0	400.0
80MHz	bonded	long	GI	58.5	117.0	175.5	234.0	351.0	468.0	526.5	585.0	702.0	780.0
80MHz	bonded	short	GI	65.0	130.0	195.0	260.0	390.0	520.0	585.0	650.0	780.0	866.7
160MHz	bonded	long	GI	117.0	234.0	351.0	468.0	702.0	936.0	1053.0	1170.0	1404.0	1560.0
160MHz	bonded	short	GI	130.0	260.0	390.0	520.0	780.0	1040.0	1170.0	1300.0	1560.0	1733.3

Three Spatial Streams													
802.11ac Modulation & Coding Schema				MC50	MC51	MC52	MC53	MC54	MC55	MC56	MC57	MC58	MC59

Figure 174. Global Settings .11ac



### *Procedure for Configuring Global 802.11ac IAP Settings*

1. **802.11ac Mode:** Select **Enabled** to allow the AP to operate in 802.11ac mode. If you select **Disabled**, then 802.11ac operation is disabled on the AP.
2. **80MHz Guard interval:** This is the length of the interval between transmission of symbols (the smallest unit of data transfer) when you are using 80MHz bonded channels. (See “[Higher Channel Widths \(Bonding\)](#)” on page 52.) Select **Short** to increase the data transmission rate by decreasing wait intervals in signal transmission. Select **Long** to use the standard interval. The default is Short.



*80MHz auto bonding for 5 GHz channels may be enabled in the CLI. This automatically selects the best channels for bonding. This is disabled by default. Under the `interface iap` command, enter `global-ac-settings`, and then enable the `auto-bond-80mhz` setting. See “[Higher Channel Widths \(Bonding\)](#)” on page 52.*

3. **MU-MIMO:** This stands for the Multiple-User form of Multiple-Input Multiple-Output wireless communication, which is available on Wave 2 802.11ac APs. This can help the AP be more efficient with MU-MIMO enabled clients. For example, the XD2-240’s Wave 2 radios have 4 antennas each. The mix of client devices connecting to the AP is likely to average fewer antennas. If MU-MIMO is enabled, then the AP radio could, for example, communicate concurrently with two clients that each have 2-antenna radios with MU-MIMO capability.
4. **Beamforming:** Beamforming is used for directional signal transmission or reception. This method results in an increased range for devices supporting beamforming. Riverbed Wave 2 products support beamforming only for 802.11ac beamforming capable clients.
5. **Max MCS:** Select the highest Modulation and Coding Scheme level that may be used with **1** or **2 Spatial Streams**. For models with 3x3 radios, there is a setting for **3 Spatial Streams**, and for models with 4x4 radios, there is a setting for **4 Spatial Streams**. These settings may be used to

limit the highest level of modulation to 64-QAM, or allow 256-QAM with its higher data rate. It also determines the coding scheme used for error correction. Higher MCS levels allocate fewer bits to error correction, and thus a higher proportion is used for data transfer. The default **Max MCS** value is **MCS9**.

The higher the MCS values, the higher the data rate, as shown in **802.11ac Supported Rates**, below. Higher MCS levels require higher signal-to-noise ratios (i.e., a less noisy environment) and shorter transmission distances. See [“Higher Precision in the Physical Layer” on page 51](#).

The maximum number of separate data streams that may be transmitted by the antennas of each IAP is determined by whether the AP has 2x2, 3x3, or 4x4 radios. For a device that has 2x2 radios, such as the XR-620, the settings for three or more spatial streams are not shown. See [“Up to Eight Simultaneous Data Streams—Spatial Multiplexing” on page 48](#).

6. **802.11ac Supported Rates:** This list shows the optimum data rates that can be expected, based on the number of spatial streams that a station can handle, and on your settings for Max MCS, Guard Interval, and the use of bonded channels, up to 80MHz wide.

## Global Settings .11u

### Understanding 802.11u

As the number of access points available in public venues increases, mobile devices users have a harder time distinguishing usable SSIDs from the tens, if not hundreds of access points visible. Using the 802.11u protocol, access points may broadcast information about the services and access that they offer and to respond to queries for additional information related to the facilities that the downstream service network provides.

The type of information broadcast or available from 802.11u-compliant access points includes:

- **Access Network Type.** Indicates the type of network available. For example: public or private, free or charged, etc.

- **Internet Connectivity.** Indicates whether the network provides Internet connectivity.
- **Authentication.** Indicates whether additional authentication steps will be required to use the network as well as the network authentication types that are in use.
- **Venue Information.** The type and name of the location where the access point is found.
- **Identification.** A globally unique identification for the access point.
- **IPv4/IPv6 Addressing.** Indicate the type of IP addressing (IPv4 and/or IPv6) and NATing that is performed by the network.
- **Roaming Consortium.** The service network may be connected to one or more roaming providers, called consortia, that allow access points from multiple service providers to be used transparently through a single paid service. The access point may advertise multiple consortia to mobile devices.
- **Domain Names.** A list of domain names to which the mobile user may end up belonging based on authentication credentials used.
- **Cellular Networks.** The service network may have arrangements with one or more cellular service providers who can transparently provide wireless and Internet connectivity.

Configuration Changes are Ready for Saving Logged in as: admin

802.11u Interworking  Off  On

Access Network Type Private network

Internet Connectivity  Provided  Unspecified

Additional Step Required for Access  Disabled  Enabled

Venue Group Unspecified

Venue Type Unspecified

HESSID

IPv4 Availability IPv4 address availability not known

IPv6 Availability IPv6 availability not known

Roaming Consortium

Domain Names

Cell Network MCC:  MNC:

Network Authentication Types Type

Uri

Venue Names English   Chinese

Figure 175. 802.11u Global Settings

### *Procedure for Configuring 802.11u Settings*

Use this window to establish the 802.11u configuration.

1. **802.11u Internetworking.** Click **On** to enable 802.11u protocol operation.
2. **Access Network Type:** This indicates the type of network supported by the access point. The choices are:
  - a. **Chargeable public network**

- b. Emergency services only network**
  - c. Free public network**
  - d. Personal device network**
  - e. Private network with guest access**
  - f. Test or experimental network**
  - g. Wildcard**—all of the networks above are supported.
- 3. Internet Connectivity.** Click **Provided** if Internet connectivity is available through the access point from the back end provider to which the mobile user ends up belonging. Click **Unspecified** otherwise—for example, depending on the SLAs (service level agreements) of the mobile user, Internet access may or may not be provided.
  - 4. Additional Step Required for Access.** Click **Disabled** if no additional authentication steps will be required to complete the connection and **Enabled** otherwise. The available authentication techniques are described in the **Network Authentication Types** field ([Step 13](#)).
  - 5. Venue Group.** Select the general type of venue that the access point is located in. Various choices are available, including **Business**, **Residential**, and **Outdoor**. For each **Venue Group**, a further set of sub-choices are available in the **Venue Type** field below. The particular name of the venue is specified in the **Venue Names** field ([Step 14](#)).
  - 6. Venue Type.** For each of the **Venue Group** choices, a further set of sub-choices are available. For example, if you set **Venue Group** to **Assembly**, the choices include **Amphitheater**, **Area**, **Library**, and **Theatre**.
  - 7. HESSID.** Enter the globally unique homogeneous ESS ID. This SSID is marked as being HotSpot 2.0 capable. This SSID attribute is global—if 802.11u is enabled and HotSpot 2.0 is enabled, then all SSIDs will have HotSpot 2.0 capability.
  - 8. IPv4 Availability.** Select the type of IPv4 addressing that will be assigned by the network upon connection. NATed addresses are IP addresses that have been changed by mapping the IP address and port number to IP

addresses and new port numbers routable by other networks. **Double NATed** addresses go through two levels of NATing. **Port restricted IPv4 addresses** refer to specific UDP and TCP port numbers associated with standard Internet services; for example, port 80 for web pages. The choices for this field are:

- a. **Double NATed private IPv4 address available**
  - b. **IPv4 address not available**
  - c. **IPv4 address availability not known**
  - d. **Port-restricted IPv4 address available**
  - e. **Port-restricted IPv4 address and double NATed IPv4 address available**
  - f. **Port-restricted IPv4 address and single NATed IPv4 address available**
  - g. **Public IPv4 address available**
  - h. **Single NATed private IPv4 address available**
9. **IPv6 Availability.** Select the type of IPv6 addressing that is available from the network upon connection.
- a. **IPv6 address not available**
  - b. **IPv6 address availability not known**
  - c. **IPv6 address available**
10. **Roaming Consortium.** Each of the roaming consortia has an organizational identifier (OI) obtained from IEEE that unique identifies the organization. This is similar to the OUI part of a MAC address. Use this control to build up a list of OIs for the consortia available. Enter the OI as a hexadecimal string of between 6 and 30 characters in the **Add** field and click **Add**. The OI will appear in the list. An OI may be deleted by selecting it in the list and clicking **Delete**. All OIs may be deleted by clicking **Reset**.

- 11. Domain Names.** Use this control to build up a list of domain names. Enter the name in the **Add** field and click **Add**, and it will appear in the list. A name may be deleted by selecting it in the list and clicking **Delete**. All names may be deleted by clicking **Reset**.
- 12. Cell Network.** Each of the cell networks is identified by a mobile country code (MCC) and mobile network code (MNC). Use this control to build up a list of cell networks. Enter the MCC as a three digit number and the MNC as a two or three digit number and click **Add**. The cell network will appear in the list. A cell network may be deleted by selecting it in the list and clicking **Delete**. All networks may be deleted by clicking **Reset**.
- 13. Network Authentication Types.** Each network authentication that is in use on the network should be specified in this list. The choices are:

  - a. Acceptance of terms and conditions.** This choice displays a web page asking for the user's acceptance of terms and conditions of use. The URL should be specified in the URL field before clicking **Add**.
  - b. DNS redirection.** Rather than use the DNS server on the network, the redirection points to a different server.
  - c. HTTP/HTTPS redirection.** This choice causes the user's first web page reference to be redirected to a different URL for login or other information. The URL should be specified in the URL field before clicking **Add**.
  - d. On-line enrollment supported.** This choice indicates that the user may sign up for network access as part of the authentication process.

When **Add** is clicked the authentication type and optional URL will appear in the list. An authentication type may be deleted by selecting it in the list and clicking **Delete**. All authentication types may be deleted by clicking **Reset**.

14. **Venue Names.** The list of names associated with the venue are specified here. A venue name may be added to the list in English or Chinese. Enter the name in the appropriate field and click **Add**. The name will appear in the list. A name may be deleted by selecting it in the list and clicking **Delete**. All names may be deleted by clicking **Reset**.

## Advanced RF Settings

This window allows you to establish RF settings, including automatically configuring channel allocation and cell size, and configuring radio assurance and standby modes. Changes you make on this page are applied to all IAPs, without exception.

Logged in as: admin

**RF Monitor**

RF Monitor Mode:  Off  Timeshare  Dedicated

Timeshare Scanning Interval (6-600):  seconds

Timeshare Station Threshold (0-240):  associated stations

Timeshare Traffic Threshold (0-50000):  packets/second

**RF Resilience**

Radio Assurance Mode:

Enable Standby Mode:  Yes  No

Standby Target Address:

**RF Power & Sensitivity**

Set Cell Size:

Auto Cell Period (seconds):

Auto Cell Size Overlap (%):

Auto Cell Minimum Cell Size:

Auto Cell Minimum Tx Power (dBm):

Auto Cell Configuration:

Sharp Cell:  Off  On

**RF Spectrum Management**

Configuration Status: Idle

Band Configuration:    Options:  Negotiate  Full Scan  Non-Radar

Channel Configuration:  Include WDS

Auto Channel Configuration Mode:  On System PowerUp  Disabled

Auto Channel Configure on Time (none or [day] hh:mm[am|pm] ...):

Channel List Selection:

<input checked="" type="checkbox"/> 1	<input type="checkbox"/> 2	<input type="checkbox"/> 3	<input type="checkbox"/> 4	<input type="checkbox"/> 5	<input checked="" type="checkbox"/> 6	<input type="checkbox"/> 7	<input type="checkbox"/> 8	<input type="checkbox"/> 9	<input type="checkbox"/> 10	<input checked="" type="checkbox"/> 11
<input checked="" type="checkbox"/> 36	<input checked="" type="checkbox"/> 40	<input checked="" type="checkbox"/> 44	<input checked="" type="checkbox"/> 48							
<input checked="" type="checkbox"/> 149	<input checked="" type="checkbox"/> 153	<input checked="" type="checkbox"/> 157	<input checked="" type="checkbox"/> 161	<input type="checkbox"/> 165						

Auto Channel List:

**Station Assurance**

Figure 176. Advanced RF Settings



### About Standby Mode

Standby Mode supports the AP-to-AP fail-over capability. When you enable Standby Mode, the AP functions as a backup unit, and it enables its radios if it detects that its designated target AP has failed. The use of redundant APs to provide this fail-over capability allows APs to be used in mission-critical applications. In Standby Mode, an AP monitors beacons from the target AP. When the target has not been heard from for 40 seconds, the standby AP enables its radios until it detects that the target AP has come back online. Standby Mode is off by default. Note that you must ensure that the configuration of the standby AP is correct. This window allows you to enable or disable Standby Mode and specify the primary AP that is the target of the backup unit. See also, “[Failover Planning](#)” on page 56.

### *Procedure for Configuring Advanced RF Settings*

#### RF Monitor



*We recommend using **iap1** for monitoring on AP models with up to four radios, as this radio assignment results in the best overall traffic throughput for the AP. See “[IAP Settings](#)” on page 319.*

1. **RF Monitor Mode:** RF monitoring permits the operation of features like intrusion detection. The monitor may operate in **Dedicated** mode, or in **Timeshare** mode which allows the radio to divide its time between monitoring and acting as a standard radio that allows stations to associate to it. **Timeshare** mode is especially useful for small APs with two IAPs, such as the XR-500/600 and XR-1000 Series, allowing one IAP to be shared between monitoring the airwaves for problems and providing services to stations. Settings allow you to give priority to monitoring or wireless services, depending on your needs. The default Monitor Mode is **Off** for the XR-500/600 Series, **Timeshare** mode for XR-1000 Series, and **Dedicated** for higher models.

If **Timeshare** mode is selected, you may adjust the following settings:

- **Timeshare Scanning Interval (6-600):** number of seconds between monitor (off-channel) scans.

- **Timeshare Station Threshold (0-240):** when the number of stations associated to the monitor radio exceeds this threshold, scanning is halted.
- **Timeshare Traffic Threshold (0-50000):** when the number of packets per second handled by the monitor radio exceeds this threshold, scanning is halted.

## RF Resilience

2. **Radio Assurance Mode:** When this mode is enabled, the monitor radio performs loopback tests on the AP. This mode requires RF Monitor Mode to be enabled (**Dedicated** or **Timeshare** mode, see [Step 1](#)) to support self-monitoring functions. It also requires a radio to be set to monitoring mode (see [""](#) on page 541).

Operation of Radio Assurance mode is described in detail in [“AP Monitor and Radio Assurance Capabilities”](#) on page 541.

The Radio Assurance mode scans and sends out probe requests on each channel, in turn. It listens for all probe responses and beacons. These tests are performed continuously (24/7). If no beacons or probe responses are observed from a radio for a predetermined period, Radio Assurance mode will take action according to the preference that you have specified:

- **Failure alerts only**—The AP will issue alerts in the Syslog, but will not initiate repairs or reboots.
  - **Failure alerts & repairs, but no reboots**—The AP will issue alerts and perform resets of one or all of the radios if needed.
  - **Failure alerts & repairs & reboots if needed**—The AP will issue alerts, perform resets, and schedule reboots if needed.
  - **Disabled**—Disable radio assurance tests (no self-monitoring occurs). Loopback tests are disabled by default.
3. **Enable Standby Mode:** Choose **Yes** to enable this AP to function as a backup unit for the target AP, or choose **No** to disable this feature. See [“About Standby Mode”](#) on page 365.

4. **Standby Target Address:** If you enabled the Standby Mode, enter the MAC address of the target AP (i.e., the address of the primary AP that is being monitored and backed up by this AP). To find this MAC address, open the AP Info window on the target AP, and use the Gigabit1 MAC Address.

### RF Power and Sensitivity

For an overview of RF power and cell size settings, please see “Capacity and Cell Sizes” on page 40 and “Fine Tuning Cell Sizes” on page 41.



*To use the Auto Cell Size feature, the following additional settings are required: all IAPs that will use Auto Cell must have **Cell Size** set to **auto**. See “Procedure for Manually Configuring IAPs” on page 320.*

*It is not necessary for RF Monitor Mode to be turned on, and you don't need to have any radio set to monitor mode. See “RF Monitor” on page 365.*

5. **Set Cell Size:** Cell Size may be set globally for all enabled IAPs to **Auto**, **Large**, **Medium**, **Small**, or **Max** using the buttons.
6. **Auto Cell Period (seconds):** You may set up auto-configuration to run periodically, readjusting optimal cell sizes for the current conditions. Enter a number of seconds to specify how often auto-configuration will run. If you select **None**, then auto-configuration of cell sizing will not be run periodically. You do not need to run Auto Cell often unless there are a lot of changes in the environment. If the RF environment is changing often, running Auto Cell every twenty-four hours (86400 seconds) should be sufficient). The default value is **None**.
7. **Auto Cell Size Overlap (%):** Enter the percentage of cell overlap that will be allowed when the AP is determining automatic cell sizes. For 100% overlap, the power is adjusted such that neighboring APs that hear each other best will hear each other at -70dB. For 0% overlap, that number is -90dB. The default value is **50%**.

8. **Auto Cell Min Cell Size:** Use this setting if you wish to set the minimum cell size that Auto Cell may assign. The values are **Default**, **Large**, **Medium**, or **Small**.
9. **Auto Cell Min Tx Power (dBm):** Enter the minimum transmit power that the AP can assign to a radio when adjusting automatic cell sizes. The default value is **10**.
10. **Auto Cell Configuration:** Click this button to instruct the AP to determine and set the best cell size for each enabled IAP whose **Cell Size** is **auto** on the [IAP Settings](#) window, based on changes in the environment. This is the recommended method for setting cell size. You may look at the Tx and Rx values on the [IAP Settings](#) window to view the cell size settings that were applied.
11. **Sharp Cell:** This feature reduces interference between neighboring APs or other Access Points by limiting to a defined boundary (cell size) the trailing edge bleed of RF energy. Choose **On** to enable the Sharp Cell functionality, or choose **Off** to disable this feature. See also, “[Fine Tuning Cell Sizes](#)” on page 41. This feature is available on 802.11n radios on APs, but not on 802.11ac radios.

The Sharp Cell feature only works when the cell size is Small, Medium, or Large (or Auto)—but not Max. If IAP cell size is set to Max, the Sharp Cell feature will be disabled for that radio.

### RF Spectrum Management

12. **Configuration Status:** Shows the status of auto channel configuration. If an operation is in progress, the approximate time remaining until completion is displayed; otherwise **Idle** is displayed.
13. **Band Configuration:** Automatic band configuration is the recommended method for assigning bands to the abgn IAPs. It runs only on command, assigning IAPs to the 2.4GHz or 5GHz band when you click the **Auto Configure** button. The AP uses its radios to listen for other APs on the same channel, and it assigns bands based on where it finds the least interference.

Auto band assigns as many IAPs to the 5 GHz band as possible when there are other APs within earshot. It does this by determining how many APs are in range and then picking the number of radios to place in the 2.4 GHz band. Note that for another AP to be considered to be in range, the other AP must be visible via both the wireless and wired networks—the AP must be listed in the [Network Map](#) table, its entry must have **In Range** set to **Yes**, and it must have at least one active IAP with an SSID that has broadcast enabled.

Auto band runs separately from auto channel configuration. If a radio's band is changed, associated stations will be disconnected and will then reconnect.

- 14. Channel Configuration:** Automatic channel configuration is a method for channel allocation. When the AP performs auto channel configuration, you may optionally instruct it to first negotiate with any other nearby APs that have been detected, to determine whether to stagger the start time for the procedure slightly. Thus, nearby APs will not run auto channel at the same time. This prevents APs from interfering with each other's channel assignments.



*Note that Auto Channel normally assigns individual channels. However, if you select **Auto bond 5GHz channels** on the [Global Settings .11n](#) page, and have 40MHz channels set up prior to running Auto Channel, those bonds will be preserved.*

The **Configuration Status** field displays whether an Auto Configure cycle is currently running on this AP or not.

Click **Auto Configure** to instruct the AP to determine the best channel allocation settings for each enabled IAP and select the channel automatically, based on changes in the environment. This is the recommended method for channel allocation (see [“RF Spectrum Management”](#) on page 368). The following options may be selected for auto configuration:

- **Negotiate:** negotiate air-time with other APs before performing a full scan. Negotiating is slower, but if multiple APs are configuring channels at the same time the Negotiate option ensures that multiple APs don't select the same channels. Turning off the Negotiate option allows the **Auto Configure** button to manually perform auto channel without waiting, and may be used when you know that no other nearby APs are configuring their channels.
- **Full Scan:** perform a full traffic scan on all channels on all IAPs to determine the best channel allocation.
- **Non-Radar:** give preference to channels without radar-detect. See table in “[Procedure for Configuring Global 802.11an IAP Settings](#)” on page 341.
- **Include WDS:** automatically assign 5GHz to WDS client links.

Click **Factory Defaults** if you wish to instruct the AP to return all IAPs to their factory preset channels. APs do not use the same factory preset values for channel assignments. Instead, if the AP has been deployed for a while and already has data from the spectrum analyzer and Riverbed Roaming Protocol about channel usage on neighboring APs, it performs a quick auto channel using that information (without doing a full RF scan) to make an intelligent choice of channel assignments. If the AP has been rebooted and has no saved configuration or is just being deployed for the first time, it has no prior data about its RF environment. In this case, it will pick a set of compatible channel assignments at random.



*On XR-500/600 and XR-1000 Series models, the **Factory Defaults** button will not restore iap1 to monitor mode. You will need to restore this setting manually. Also, you may need to set **RF Monitor Mode** to **Timeshare Mode** again - see “[RF Monitor](#)” on page 365.*

15. **Auto Channel Configuration Mode:** This option allows you to instruct the AP to auto-configure channel selection for each enabled IAP when the AP is powered up. Choose **On AP PowerUp** to enable this feature, or choose **Disabled** to disable this feature.

16. **Auto Channel Configure on Time:** This option allows you to instruct the AP to auto-configure channel selection for each enabled IAP at a time you specify here. Leave this field blank unless you want to specify a time at which the auto-configuration utility is initiated. Time is specified in hours and minutes, using the format: **[day]hh:mm [am | pm]**. If you omit the optional **day** specification, channel configuration will run daily at the specified time. If you do not specify am or pm, time is interpreted in 24-hour military time. For example, Sat 11:00 pm and Saturday 23:00 are both acceptable and specify the same time.
17. **Channel List Selection:** This list selects which channels are available to the auto channel algorithm. Channels that are not checked are left out of the auto channel selection process. Note that channels that have been locked by the user are also not available to the auto channel algorithm.
18. **Auto Channel List: Use All Channels** selects all available channels (this does not include locked channels). **Use Defaults** sets the auto channel list back to the defaults. This omits newer channels (100-140)—many wireless NICs don't support these channels.

### Station Assurance

Station assurance monitors the quality of the connections that users are experiencing on the wireless network. You can quickly detect stations that are having problems and take steps to correct them. Use these settings to establish threshold values for errors and other problems. Station assurance is enabled by default, with a set of useful default thresholds that you may adjust as desired.

When a connection is experiencing problems and reaches one of these thresholds in the specified period of time, the AP responds with several actions: an event is triggered, a trap is generated, and a Syslog message is logged. For example, if a client falls below the threshold for **Min Average Associated Time**, this “bouncing” behavior might indicate roaming problems with the network’s RF design, causing the client to bounce between multiple APs and not stay connected longer than the time to re-associate and then jump again. This can be corrected with RF adjustments. Station assurance alerts you to the fact that this station is encountering problems.

Station Assurance	
Enable Station Assurance:	<input checked="" type="radio"/> Yes <input type="radio"/> No
Period:	<input type="text" value="60"/> seconds
Min Average Associated Time:	<input type="text" value="20"/> seconds
Max Authentication Failures:	<input type="text" value="10"/>
Max Packet Error Rate:	<input type="text" value="20"/> %
Max Packet Retry Rate:	<input type="text" value="35"/> %
Min Packet Data Rate:	<input type="text" value="10"/> Mbps
Min Received Signal Strength:	<input type="text" value="-85"/> dB
Min Signal to Noise Ratio:	<input type="text" value="10"/> dB
Max Distance from Array:	<input type="text" value="2000"/> feet

Figure 177. Station Assurance (Advanced RF Settings)

19. **Enable Station Assurance:** This is enabled by default. Click No if you wish to disable it, and click Yes to re-enable it. When station assurance is enabled, the AP will monitor connection quality indicators listed below and will display associated information on the [Station Assurance](#) Status page. When a threshold is reached, an event is triggered, a trap is generated, and a Syslog message is logged.
20. **Period:** In seconds, the period of time for a threshold to be reached. For example, the AP will check whether Max Authentication Failures has been reached in this number of seconds.
21. **Min Average Associated Time:** (seconds) Station assurance detects whether the average length of station associations falls below this threshold during a period.
22. **Max Authentication Failures:** Station assurance detects whether the number of failed login attempts reaches this threshold during a period.
23. **Max Packet Error Rate:** (%) Station assurance detects whether the packet error rate percentage reaches this threshold during a period.
24. **Max Packet Retry Rate:** (%) Station assurance detects whether the packet retry rate percentage reaches this threshold during a period.
25. **Min Packet Data Rate:** (Mbps) Station assurance detects whether the packet data rate falls below this threshold during a period.



26. **Min Received Signal Strength:** (dB) Station assurance detects whether the strength of the signal received from the station falls below this threshold during a period.
27. **Min Signal to Noise Ratio:** (dB) Station assurance detects whether the ratio of signal to noise received from the station falls below this threshold during a period.
28. **Max Distance from AP: Min Received Signal Strength:** (feet) Station assurance detects whether the distance of the station from the AP reaches this threshold during a period.

### *See Also*

[Coverage and Capacity Planning](#)

[Global Settings .11an](#)

[Global Settings .11bgn](#)

[Global Settings .11n](#)

[IAPs](#)

[IAP Settings](#)

[Radio Assurance](#)

## Hotspot 2.0

### Understanding Hotspot 2.0

Hotspot 2.0 is a part of the Wi-Fi Alliance's Passpoint certification program. It specifies additional information above and beyond that found in 802.11u, which allows mobile clients to automatically discover, select, and connect to networks based on preferences and network optimization. Mobile clients that support Hotspot 2.0 are informed of an access point's support via its beacon message.

Hotspot 2.0 messages forward several types of information to clients, including:

- **Uplink and Downlink Speeds**
- **Link Status**
- **Friendly Name**
- **Connection Capabilities** The access point will restrict the protocols that can be used by a specification of protocol and port numbers.

### Procedure for Hotspot 2.0 Settings

Use this window to establish the Hotspot 2.0 configuration.

1. **Hotspot 2.0.** Click **Enabled** to enable Hotspot 2.0 operation.
2. **Downstream Group-addressed Forwarding.** Click **Enabled** to allow the access point to forward group-addressed traffic (broadcast and multicast) to all connected devices. Click **Disabled** to cause the access point to convert group-addressed traffic to unicast messages.

Logged in as: admin

Configuration Changes are Ready for Saving

**Hotspot 2.0**  Enabled  Disabled

**Downstream Group-addressed Forwarding**  Enabled  Disabled

**WAN Downlink Speed**

**WAN Uplink Speed**

**WAN Link Status**

**English Operator Friendly Name**  Delete

**Chinese Operator Friendly Name**  Delete

**Connection Capabilities**
Reset Connection Capabilities

Name	Protocol	Port	Status	
ICMP	<input type="text" value="1"/>	<input type="text" value="0"/>	<input type="text" value="open"/>	<span style="background-color: #2c5e8c; color: white; padding: 5px 10px; border-radius: 5px;">Delete</span>
FTP	<input type="text" value="6"/>	<input type="text" value="20"/>	<input type="text" value="open"/>	<span style="background-color: #2c5e8c; color: white; padding: 5px 10px; border-radius: 5px;">Delete</span>
SSH	<input type="text" value="6"/>	<input type="text" value="22"/>	<input type="text" value="open"/>	<span style="background-color: #2c5e8c; color: white; padding: 5px 10px; border-radius: 5px;">Delete</span>
HTTP	<input type="text" value="6"/>	<input type="text" value="80"/>	<input type="text" value="open"/>	<span style="background-color: #2c5e8c; color: white; padding: 5px 10px; border-radius: 5px;">Delete</span>
TLS VPN	<input type="text" value="6"/>	<input type="text" value="443"/>	<input type="text" value="open"/>	<span style="background-color: #2c5e8c; color: white; padding: 5px 10px; border-radius: 5px;">Delete</span>
PPTP VPN	<input type="text" value="6"/>	<input type="text" value="1723"/>	<input type="text" value="open"/>	<span style="background-color: #2c5e8c; color: white; padding: 5px 10px; border-radius: 5px;">Delete</span>
VoIP TCP	<input type="text" value="6"/>	<input type="text" value="5060"/>	<input type="text" value="open"/>	<span style="background-color: #2c5e8c; color: white; padding: 5px 10px; border-radius: 5px;">Delete</span>
IKEv2 ISAKMP	<input type="text" value="17"/>	<input type="text" value="500"/>	<input type="text" value="open"/>	<span style="background-color: #2c5e8c; color: white; padding: 5px 10px; border-radius: 5px;">Delete</span>
VoIP UDP	<input type="text" value="17"/>	<input type="text" value="5060"/>	<input type="text" value="open"/>	<span style="background-color: #2c5e8c; color: white; padding: 5px 10px; border-radius: 5px;">Delete</span>
IKEv2 IPsec	<input type="text" value="17"/>	<input type="text" value="4500"/>	<input type="text" value="open"/>	<span style="background-color: #2c5e8c; color: white; padding: 5px 10px; border-radius: 5px;">Delete</span>
ESP	<input type="text" value="50"/>	<input type="text" value="0"/>	<input type="text" value="open"/>	<span style="background-color: #2c5e8c; color: white; padding: 5px 10px; border-radius: 5px;">Delete</span>

Create

Figure 178. Hotspot 2.0 Settings

3. **WAN Downlink Speed.** Enter the WAN downlink speed in kbps into the field.
4. **WAN Uplink Speed.** Enter the WAN uplink speed in kbps into the field.
5. **English/Chinese Operator Friendly Name.** Enter an English or Chinese name into one of the fields. An incorrectly entered name can be deleted by clicking the corresponding **Delete**.
6. **Connection Capabilities.** A Hotspot 2.0 access point limits the particular protocols that clients may use. The set of default protocols is shown initially. This table specifies the protocols in terms of:
  - a. A common **Name**, such as FTP or HTTP.
  - b. A **Protocol** number. For example 1 for ICMP, 6 for TCP, 17 for UDP, and 50 for Encapsulated Security Protocol in IPsec VPN connections.
  - c. **Port** number for UDP/TCP connection.
  - d. **Status**: one of **open**, **closed** or **unknown**.

Any of the entries may be deleted by clicking the corresponding **Delete** button. New entries may be created by entering the name of the protocol in the box beside the **Create** button, and then clicking **Create**. The new protocol will be added to the list with zeros in the protocol fields and **unknown** for the status. Enter the appropriate **Protocol** and **Port** values before setting the **Status** field to **open**.

## NAI Realms

### Understanding NAI Realm Authentication

A network access identifier (NAI) is a specification of a particular user. A NAI takes the general form of an e-mail address. Examples of NAIs are:

```
joe@example.com  
fred@foo-9.example.com  
jack@3rd.depts.example.com  
fred.smith@example.com
```

Enter new Realm Name

**REALM: Realm1**

1: 

Authentication Parameters	Optional Value	Vendor ID	Vendor Type
1: none		Vendor ID (0..16777215)	Vendor Type (0..429)
2: none		Vendor ID (0..16777215)	Vendor Type (0..429)
3: none		Vendor ID (0..16777215)	Vendor Type (0..429)
4: none		Vendor ID (0..16777215)	Vendor Type (0..429)
5: none		Vendor ID (0..16777215)	Vendor Type (0..429)

2: 

Authentication Parameters	Optional Value	Vendor ID	Vendor Type
1: none		Vendor ID (0..16777215)	Vendor Type (0..429)
2: none		Vendor ID (0..16777215)	Vendor Type (0..429)
3: none		Vendor ID (0..16777215)	Vendor Type (0..429)
4: none		Vendor ID (0..16777215)	Vendor Type (0..429)
5: none		Vendor ID (0..16777215)	Vendor Type (0..429)

3: 

Authentication Parameters	Optional Value	Vendor ID	Vendor Type
1: none		Vendor ID (0..16777215)	Vendor Type (0..429)
2: none		Vendor ID (0..16777215)	Vendor Type (0..429)
3: none		Vendor ID (0..16777215)	Vendor Type (0..429)

Figure 179. NAI Realms

The **NAI Realm** is the part of the NAI following the @ sign. For example, you might enter: **example.com**, **3rd.depts.example.com**, and **foo-9.example.com**. Use the **NAI Realms** page, in conjunction with the **NAI EAP** page, to specify the authentication techniques to be used to access that realm with appropriate parameters.

### *Procedure for NAI Realms Settings*

Use this window to establish the names and authentication of the supported realms.

1. **Enter New Realm Name.** Enter the name of a realm in the box to the left of the **Create** button and click **Create**. The realm will be added to the **NAI Realms** list.
2. **Enter Authentication Information.** Click on the name of a realm to enter authentication settings.

3. Select **Authentication Methods**. Each realm may support up to five authentication methods. For one of the five numbered sections (1, 2, 3, 4, 5) select the method from the drop down. The choices are:
  - **none**
  - **auth-param**
  - **eap-aka**
  - **eap-aka prime**
  - **eap-fast**
  - **eap-mschap-v2**
  - **eap-sim**
  - **eap-tls**
  - **eap-ttls**
  - **gtc**
  - **md5-challenge**
  - **peap**
4. Specify **Authentication Parameters**. Each of the authentication methods may specify up to five parameters. To specify a parameter, select a **Type** from the drop-down list. The choices are:
  - **credential type**
  - **expanded eap method**
  - **expanded inner eap method**
  - **inner authentication eap method type**
  - **non-eap inner authentication type**
  - **tunneled eap method credential type**

For each type, a value or a vendor ID and type may be specified, as applicable.
5. Repeat these steps for each additional authentication method.

## Intrusion Detection

The Riverbed AP employs a number of IDS/IPS (Intrusion Detection System/Intrusion Prevention System) strategies to detect and prevent malicious attacks on the wireless network. Use this window to adjust intrusion detection settings.

Logged in as: admin

Configuration Changes are Ready for Saving

**Intrusion Detection Mode:**  Off  Standard

**Auto Block Unknown Rogue APs:**  Off  On

**Auto Block RSSI:**

**Auto Block Level:**

**Auto Block Network Types:**  All  IBSS/Ad-hoc only  ESS/Infrastructure only

**Auto Block Whitelist** Channels:

---

**DoS Attack Detection Settings**

Attack/Event	Mode	Threshold (packets)	Period (seconds)
<b>Beacon Flood:</b>	<input type="radio"/> Off <input type="radio"/> Auto <input checked="" type="radio"/> Manual	<input type="text" value="20000"/>	<input type="text" value="60"/>
<b>Probe Request Flood:</b>	<input type="radio"/> Off <input type="radio"/> Auto <input checked="" type="radio"/> Manual	<input type="text" value="1000"/>	<input type="text" value="60"/>
<b>Authentication Flood:</b>	<input type="radio"/> Off <input type="radio"/> Auto <input checked="" type="radio"/> Manual	<input type="text" value="100"/>	<input type="text" value="60"/>
<b>Association Flood:</b>	<input type="radio"/> Off <input type="radio"/> Auto <input checked="" type="radio"/> Manual	<input type="text" value="100"/>	<input type="text" value="60"/>
<b>Disassociation Flood:</b>	<input type="radio"/> Off <input type="radio"/> Auto <input checked="" type="radio"/> Manual	<input type="text" value="100"/>	<input type="text" value="60"/>
<b>Deauthentication Flood:</b>	<input type="radio"/> Off <input type="radio"/> Auto <input checked="" type="radio"/> Manual	<input type="text" value="100"/>	<input type="text" value="60"/>
<b>EAP Handshake Flood:</b>	<input type="radio"/> Off <input type="radio"/> Auto <input checked="" type="radio"/> Manual	<input type="text" value="100"/>	<input type="text" value="60"/>
<b>Null Probe Response:</b>	<input type="radio"/> Off <input checked="" type="radio"/> On	<input type="text" value="2"/>	<input type="text" value="60"/>
<b>MIC Error Attack:</b>	<input type="radio"/> Off <input checked="" type="radio"/> On	<input type="text" value="2"/>	<input type="text" value="60"/>
<b>Disassociation Attack:</b>	<input type="radio"/> Off <input checked="" type="radio"/> On	<input type="text" value="1"/>	<input type="text" value="60"/>
<b>Deauthentication Attack:</b>	<input type="radio"/> Off <input checked="" type="radio"/> On	<input type="text" value="1"/>	<input type="text" value="60"/>
<b>Duration Attack:</b>	<input type="radio"/> Off <input checked="" type="radio"/> On	<input type="text" value="10"/>	<input type="text" value="2"/>
<b>Duration Attack NAV:</b>	<input type="text" value=""/>	ms	

---

**Impersonation Detection Settings**

Attack/Event	Mode	Threshold (packets)	Period (seconds)
<b>AP impersonation</b>	<input type="radio"/> Off <input checked="" type="radio"/> On	<input type="text" value="1"/>	<input type="text" value="60"/>
<b>Station impersonation</b>	<input type="radio"/> Off <input checked="" type="radio"/> On	<input type="text" value="5"/>	<input type="text" value="600"/>
<b>Evil twin attack</b>	<input type="radio"/> Off <input checked="" type="radio"/> On		
<b>Sequence number anomaly</b>	<input type="radio"/> Off <input type="radio"/> Data <input checked="" type="radio"/> Management		

Figure 180. Intrusion Detection Settings

The AP provides a suite of intrusion detection and prevention options to improve network security. You can separately enable detection of the following types of problems:

- **Rogue Access Point Detection and Blocking**

Unknown APs are detected, and may be automatically blocked based on a number of criteria. See [“About Blocking Rogue APs” on page 381](#).

- **Denial of Service (DoS) or Availability Attack Detection**

A DoS attack attempts to flood an AP with communications requests so that it cannot respond to legitimate traffic, or responds so slowly that it becomes effectively unavailable. The AP can detect a number of types of DoS attacks, as described in the table below. When an attack is detected, the AP logs a Syslog message at the Alert level.

- **Impersonation Detection**

These malicious attacks use various techniques to impersonate a legitimate AP or station, often in order to eavesdrop on wireless communications. The AP detects a number of types of impersonation attacks, as described in the table below. When an attack is detected, the AP logs a Syslog message at the Alert level.

Type of Attack	Description
<i>DoS Attacks</i>	
Beacon Flood	Generating thousands of counterfeit 802.11 beacons to make it hard for stations to find a legitimate AP.
Probe Request Flood	Generating thousands of counterfeit 802.11 probe requests to overburden the AP.
Authentication Flood	Sending forged Authenticates from random MAC addresses to fill the AP's association table.
Association Flood	Sending forged Associates from random MAC addresses to fill the AP's association table.

Type of Attack	Description
Disassociation Flood	Flooding the AP with forged Disassociation packets.
Deauthentication Flood	Flooding the AP with forged Deauthenticates.
EAP Handshake Flood	Flooding an AP with EAP-Start messages to consume resources or crash the target.
Null Probe Response	Answering a station probe-request frame with a null SSID. Many types of popular NIC cards cannot handle this situation, and will freeze up.
MIC Error Attack	Generating invalid TKIP data to exceed the AP's MIC error threshold, suspending WLAN service.
Disassociation Attack (Omerta)	Sending forged disassociation frames to all stations on a channel in response to data frames.
Deauthentication Attack	Sending forged deauthentication frames to all stations on a channel in response to data frames.
Duration Attack (Duration Field Spoofing)	Injecting packets into the WLAN with huge duration values. This forces the other nodes in the WLAN to keep quiet, since they cannot send any packet until this value counts down to zero. If the attacker sends such frames continuously it silences other nodes in the WLAN for long periods, thereby disrupting the entire wireless service.
<b><i>Impersonation Attacks</i></b>	
AP impersonation	Reconfiguring an attacker's MAC address to pose as an authorized AP. Administrators should take immediate steps to prevent the attacker from entering the WLAN.
Station impersonation	Reconfiguring an attacker's MAC address to pose as an authorized station. Administrators should take immediate steps to prevent the attacker from entering the WLAN.
Evil twin attack	Masquerading as an authorized AP by beaconing the WLAN's service set identifier (SSID) to lure users.



Type of Attack	Description
Sequence number anomaly	<p>A sender may use an Add Block Address request (ADDBA - part of the Block ACK mechanism) to specify a sequence number range for packets that the receiver can accept.</p> <p>An attacker spoofs an ADDBA request, asking the receiver to reset its sequence number window to a new range. This causes the receiver to drop legitimate frames, since their sequence numbers will not fall in that range.</p>

Some types of intrusion detection are turned off by default. These options affect AP performance more than other the other types of detection offered by the AP, thus they are disabled by default.

- Null probe response
- Deauthentication Attack
- Disassociation Attack
- AP Impersonation
- Station Impersonation
- Sequence Number Anomaly

### About Blocking Rogue APs

If you classify a rogue AP as **blocked** (see [“Rogue Control List” on page 270](#)), then the AP will take measures to prevent stations from staying associated to the rogue. When the monitor radio is scanning, any time it hears a beacon from a blocked rogue it sends out a broadcast “deauth” signal using the rogue’s BSSID and source address. This has the effect of disconnecting all of a rogue AP’s clients approximately every 5 to 10 seconds, which is enough to make the rogue unusable.

The Intrusion Detection window allows you to set up **Auto Block** parameters so that unknown APs get the same treatment as explicitly blocked APs. This may result in many APs being blocked so use caution with auto block, and be sure to abide by applicable regulations. *See the [Caution on page 383](#)*. By default, auto blocking is turned off. Auto blocking provides two parameters for qualifying

blocking so that APs must meet certain criteria before being blocked. This keeps the AP from blocking every AP that it detects. You may:

- Set a minimum RSSI value for the AP—for example, if an AP has an RSSI value of -90, it is probably a harmless AP belonging to a neighbor and not in your building.
- Block based on encryption level.
- Block based on whether the AP is part of an ad hoc network or infrastructure network.
- Specify channels to be whitelisted. Rogues discovered on these channels are excluded from auto blocking. This allows specified channels to be freely used by customer or guests for their APs.

## RF Intrusion Detection and Auto Block Mode

### *Procedure for Configuring Intrusion Detection*

1. **Intrusion Detection Mode:** This option allows you to choose the **Standard** intrusion detection method, or you can choose **Off** to disable this feature. See [“AP Monitor and Radio Assurance Capabilities” on page 541](#) for more information.
  - **Standard**—enables the monitor radio to collect Rogue AP information.
  - **Off**—intrusion detection is disabled.
2. **Auto Block Unknown Rogue APs:** Enable or disable auto blocking (see [“About Blocking Rogue APs” on page 381](#)). You will be shown a Caution statement (below) and the WMI will ask whether you wish to proceed.

**!** *CAUTION: Selecting and engaging Auto Block may result in many APs being blocked. User caution in configuring and operating any form of Auto Block is highly recommended, as auto-blocking may be subject to significant statutory and U.S. Federal Communications Commission (FCC) regulatory controls, restrictions, enforcement actions and penalties.*

*User is solely responsible for making sure that all uses of any auto-blocking feature(s) of this product are fully compliant with all applicable statutes, regulations, FCC enforcement actions and rules, etc. regarding Wi-Fi blocking. See for example FCC Enforcement Advisory No. 2015-01 dated January 27, 2015.*

*All uses of any auto-blocking feature(s) in this product are solely at User's discretion and individual choice. User assumes all liability and responsibility for all such uses. Riverbed assumes no liability or responsibility for any discretionary decision by User to configure, engage and to use any auto-blocking feature(s) of this product.*

Note that in order to set Auto Block RSSI and Auto Block Level, you must set Auto Block Unknown Rogue APs to **On**. Then the remaining Auto Block fields will be active.

3. **Auto Block RSSI:** Set the minimum RSSI for rogue APs to be blocked. APs with lower RSSI values will not be blocked. They are assumed to be farther away, and probably belonging to neighbors and posing a minimal threat.
4. **Auto Block Level:** Select rogue APs to block based on the level of encryption that they are using. The choices are:
  - Automatically block unknown rogue APs regardless of encryption.
  - Automatically block unknown rogue APs with no encryption.
  - Automatically block unknown rogue APs with WEP or no encryption.

5. **Auto Block Network Types:** Select rogues to automatically block by applying the criteria above only to networks of the type specified below. The choices are:
  - **All**—the unknown rogues may be part of any wireless network.
  - **IBSS/AD Hoc only**—only consider auto blocking rogues if they belong to an ad hoc wireless network (a network of client devices without a controlling Access Point, also called an Independent Basic Service Set—IBSS).
  - **ESS/Infrastructure only**—only consider auto blocking rogue APs if they are in infrastructure mode rather than ad hoc mode.
6. **Auto Block Whitelist:** Use this list to specify channels to be excluded from automatic blocking. If you have enabled **Auto Block**, it will not be applied to rogues detected on the whitelisted channels. Use the **Add Channel** drop-down to add entries to the **Channels** list, one at a time. You can delete entries from the list by selecting them from the **Remove Channel** drop-down list.

### DoS Attack Detection Settings

7. **Attack/Event:** The types of DoS attack that you may detect are described in the [Type of Attack Table page 379](#). Detection of each attack type may be separately enabled or disabled. For each attack, a default **Threshold** and **Period (seconds)** are specified. If the number of occurrences of the type of packet being detected exceeds the threshold in the specified number of seconds, then the AP declares that an attack has been detected. You may modify the **Threshold** and **Period**.

For the Flood attack settings, you also have a choice of **Auto** or **Manual**.

- **Manual** mode—threshold and period settings are used to detect a flood. Packets received are simply counted for the specified time period and compared against the flood threshold. The default for all of the floods is **Manual** mode.
- **Auto** mode—the AP analyzes current traffic for packets of a given type versus traffic over the past hour to determine whether a packet

flood should be detected. In this mode, threshold and period settings are ignored. This mode is useful for floods like beacon or probe floods, where the numbers of such packets detected in the air can vary greatly from installation to installation.

- 8. Duration Attack NAV (ms):** For the duration attack, you may also modify the default duration value that is used to determine whether a packet may be part of an attack. If the number of packets having at least this duration value exceeds the **Threshold** number in the specified **Period**, an attack is detected.

### Impersonation Detection Settings

- 9. Attack/Event:** The types of impersonation attack that you may detect are described in [Impersonation Attacks page 380](#). Detection of each attack type may be turned **On** or **Off** separately. For **AP** or **Station Impersonation** attacks, a default **Threshold** and **Period (seconds)** are specified. If the number of occurrences of the type of packet being detected exceeds the threshold in the specified number of seconds, then the AP declares that an attack has been detected. You may modify the **Threshold** and **Period**.
- 10. Sequence number anomaly:** You may specify whether to detect this type of attack in **Data** traffic or in **Management** traffic, or turn **Off** this type of detection.

### LED Settings

This window assigns behavior preferences for the AP's IAP LEDs.

The screenshot shows a configuration window for LED settings. It is divided into two sections: 'LED State' and 'LED Blink Behavior'. Under 'LED State', there are three radio button options: 'Disabled', 'On when radio enabled' (which is selected), and 'On when station associated'. Under 'LED Blink Behavior', there are two columns of checkboxes. The first column includes 'Beacons' (unchecked), 'Mgmt Tx' (checked), 'Mgmt Rx' (checked), and 'Probe Request Rx' (unchecked). The second column includes 'Data TX' (checked), 'Data RX' (checked), 'Broadcast Tx' (unchecked), and 'Clients Associated' (checked).

Figure 181. LED Settings

***Procedure for Configuring the IAP LEDs***

1. **LED State:** This option determines which event triggers the LEDs, either when the IAP is enabled or when a station associates with the IAP. Choose **On Radio Enabled** or **On First Association**, as desired. You may also choose Disabled to keep the LEDs from being lit. The LEDs will still light during the boot sequence, then turn off.
2. **LED Blink Behavior:** This option allows you to select when the IAP LEDs blink, based on the activities you check here. From the choices available, select one or more activities to trigger when the LEDs blink. For default behavior, see [“AP LED Operating Sequences” on page 77](#).
3. Click the **Save** button  if you wish to make your changes permanent.

***See Also***[Global Settings](#)[Global Settings .11an](#)[Global Settings .11bgn](#)[IAPs](#)[LED Boot Sequence](#)

## DSCP Mappings

DSCP is the 6-bit Differentiated Services Code Point (DiffServ) field in the IPv4 or IPv6 packet header, defined in [RFC2474](#) and [RFC2475](#). The DSCP value classifies the packet to determine the Quality of Service (QoS) required. DSCP replaces the outdated Type of Service (TOS) field.

DSCP to QoS Mapping Mode:  Off  On

DSCP to QoS Mapping

		DSCP																																
QoS		0	1	2	3	4	5	6	7	8	9	10	11	12	13	14	15	16	17	18	19	20	21	22	23	24	25	26	27	28	29	30	31	
0		<input checked="" type="radio"/>	<input checked="" type="radio"/>	<input checked="" type="radio"/>	<input checked="" type="radio"/>	<input checked="" type="radio"/>	<input checked="" type="radio"/>	<input checked="" type="radio"/>	<input checked="" type="radio"/>	<input type="radio"/>	<input checked="" type="radio"/>	<input checked="" type="radio"/>	<input checked="" type="radio"/>	<input checked="" type="radio"/>	<input checked="" type="radio"/>	<input checked="" type="radio"/>	<input checked="" type="radio"/>	<input checked="" type="radio"/>	<input checked="" type="radio"/>	<input checked="" type="radio"/>	<input checked="" type="radio"/>	<input checked="" type="radio"/>	<input checked="" type="radio"/>	<input checked="" type="radio"/>	<input checked="" type="radio"/>	<input checked="" type="radio"/>	<input checked="" type="radio"/>	<input checked="" type="radio"/>	<input checked="" type="radio"/>	<input checked="" type="radio"/>	<input checked="" type="radio"/>	<input checked="" type="radio"/>	<input checked="" type="radio"/>	<input checked="" type="radio"/>
1		<input type="radio"/>	<input type="radio"/>	<input type="radio"/>	<input type="radio"/>	<input type="radio"/>	<input type="radio"/>	<input type="radio"/>	<input type="radio"/>	<input checked="" type="radio"/>	<input type="radio"/>	<input type="radio"/>	<input type="radio"/>	<input type="radio"/>	<input type="radio"/>	<input type="radio"/>	<input type="radio"/>	<input type="radio"/>	<input type="radio"/>	<input type="radio"/>	<input type="radio"/>	<input type="radio"/>	<input type="radio"/>	<input type="radio"/>	<input type="radio"/>	<input type="radio"/>	<input type="radio"/>	<input type="radio"/>	<input type="radio"/>	<input type="radio"/>	<input type="radio"/>	<input type="radio"/>	<input type="radio"/>	<input type="radio"/>
2		<input type="radio"/>	<input type="radio"/>	<input type="radio"/>	<input type="radio"/>	<input type="radio"/>	<input type="radio"/>	<input type="radio"/>	<input type="radio"/>	<input type="radio"/>	<input type="radio"/>	<input type="radio"/>	<input type="radio"/>	<input type="radio"/>	<input type="radio"/>	<input type="radio"/>	<input type="radio"/>	<input type="radio"/>	<input type="radio"/>	<input type="radio"/>	<input type="radio"/>	<input type="radio"/>	<input type="radio"/>	<input type="radio"/>	<input type="radio"/>	<input type="radio"/>	<input type="radio"/>	<input type="radio"/>	<input type="radio"/>	<input type="radio"/>	<input type="radio"/>	<input type="radio"/>	<input type="radio"/>	<input type="radio"/>
3		<input type="radio"/>	<input type="radio"/>	<input type="radio"/>	<input type="radio"/>	<input type="radio"/>	<input type="radio"/>	<input type="radio"/>	<input type="radio"/>	<input type="radio"/>	<input type="radio"/>	<input type="radio"/>	<input type="radio"/>	<input type="radio"/>	<input type="radio"/>	<input type="radio"/>	<input type="radio"/>	<input type="radio"/>	<input type="radio"/>	<input type="radio"/>	<input type="radio"/>	<input type="radio"/>	<input type="radio"/>	<input type="radio"/>	<input type="radio"/>	<input type="radio"/>	<input type="radio"/>	<input type="radio"/>	<input type="radio"/>	<input type="radio"/>	<input type="radio"/>	<input type="radio"/>	<input type="radio"/>	<input type="radio"/>

		DSCP																																
QoS		32	33	34	35	36	37	38	39	40	41	42	43	44	45	46	47	48	49	50	51	52	53	54	55	56	57	58	59	60	61	62	63	
0		<input checked="" type="radio"/>	<input checked="" type="radio"/>	<input checked="" type="radio"/>	<input checked="" type="radio"/>	<input checked="" type="radio"/>	<input checked="" type="radio"/>	<input checked="" type="radio"/>	<input checked="" type="radio"/>	<input checked="" type="radio"/>	<input checked="" type="radio"/>	<input checked="" type="radio"/>	<input checked="" type="radio"/>	<input checked="" type="radio"/>	<input checked="" type="radio"/>	<input checked="" type="radio"/>	<input checked="" type="radio"/>	<input checked="" type="radio"/>	<input checked="" type="radio"/>	<input checked="" type="radio"/>	<input checked="" type="radio"/>	<input checked="" type="radio"/>	<input checked="" type="radio"/>	<input checked="" type="radio"/>	<input checked="" type="radio"/>	<input checked="" type="radio"/>	<input checked="" type="radio"/>	<input checked="" type="radio"/>	<input checked="" type="radio"/>	<input checked="" type="radio"/>	<input checked="" type="radio"/>	<input checked="" type="radio"/>	<input checked="" type="radio"/>	<input checked="" type="radio"/>
1		<input type="radio"/>	<input type="radio"/>	<input type="radio"/>	<input type="radio"/>	<input type="radio"/>	<input type="radio"/>	<input type="radio"/>	<input type="radio"/>	<input type="radio"/>	<input type="radio"/>	<input type="radio"/>	<input type="radio"/>	<input type="radio"/>	<input type="radio"/>	<input type="radio"/>	<input type="radio"/>	<input type="radio"/>	<input type="radio"/>	<input type="radio"/>	<input type="radio"/>	<input type="radio"/>	<input type="radio"/>	<input type="radio"/>	<input type="radio"/>	<input type="radio"/>	<input type="radio"/>	<input type="radio"/>	<input type="radio"/>	<input type="radio"/>	<input type="radio"/>	<input type="radio"/>	<input type="radio"/>	<input type="radio"/>
2		<input type="radio"/>	<input type="radio"/>	<input type="radio"/>	<input type="radio"/>	<input type="radio"/>	<input type="radio"/>	<input type="radio"/>	<input type="radio"/>	<input type="radio"/>	<input checked="" type="radio"/>	<input type="radio"/>	<input type="radio"/>	<input type="radio"/>	<input type="radio"/>	<input type="radio"/>	<input type="radio"/>	<input type="radio"/>	<input type="radio"/>	<input type="radio"/>	<input type="radio"/>	<input type="radio"/>	<input type="radio"/>	<input type="radio"/>	<input type="radio"/>	<input type="radio"/>	<input type="radio"/>	<input type="radio"/>	<input type="radio"/>	<input type="radio"/>	<input type="radio"/>	<input type="radio"/>	<input type="radio"/>	<input type="radio"/>
3		<input type="radio"/>	<input type="radio"/>	<input type="radio"/>	<input type="radio"/>	<input type="radio"/>	<input type="radio"/>	<input type="radio"/>	<input type="radio"/>	<input type="radio"/>	<input type="radio"/>	<input type="radio"/>	<input type="radio"/>	<input type="radio"/>	<input type="radio"/>	<input type="radio"/>	<input type="radio"/>	<input type="radio"/>	<input type="radio"/>	<input type="radio"/>	<input type="radio"/>	<input type="radio"/>	<input type="radio"/>	<input type="radio"/>	<input type="radio"/>	<input type="radio"/>	<input type="radio"/>	<input type="radio"/>	<input type="radio"/>	<input type="radio"/>	<input type="radio"/>	<input type="radio"/>	<input type="radio"/>	<input checked="" type="radio"/>

Figure 182. DSCP Mappings

The DSCP Mappings page shows the default mapping of each of the 64 DSCP values to one of the AP’s four QoS levels, and allows you to change these mappings.

For a detailed discussion of the operation of QoS and DSCP mappings on the AP, please see [“Understanding QoS Priority on the Wireless AP”](#) on page 277.

### Procedure for Configuring DSCP Mappings

- DSCP to QoS Mapping Mode:** Use the **On** and **Off** buttons to enable or disable the use of the DSCP mapping table to determine the QoS level applied to each packet.
- DSCP to QoS Mapping:** The radio buttons in this table show all DSCP values (0 to 63), and the QoS level to which each is mapped. To change the QoS level applied to a DSCP value, click the desired QoS level (0 to 3) underneath it.

## Roaming Assist

Roaming assist is a Riverbed feature that helps clients roam to APs that will give them high quality connections. Some smart phones and tablets will stay connected to a radio with poor signal quality, even when there's a radio with better signal strength within range. When roaming assist is triggered, the AP "assists" the device by deauthenticating it when certain parameters are met. This encourages a client with a high roaming threshold (i.e., a device that may not roam until signal quality has seriously dropped) to move to an AP that gives it a better signal. The deauthentication is meant to cause the client to choose a different radio. You can specify the device types that will be assisted in roaming.

The roaming threshold is the difference in signal strength between radios that will trigger a deauthentication. If the client's signal is lower than the sum of the threshold and the stronger neighbor radio's RSSI, then we "assist" the client. For example:

Threshold = -5  
RSSI of neighbor AP = -65  
RSSI of client = -75  
 $-75 < (-5 + -65)$  : Therefore client will roam

Another example:

Threshold = -15  
RSSI of neighbor AP = -60  
RSSI of station = -70  
 $-70 > (-15 + -60)$  : Client will not roam



Roaming Assist

Enable Roaming Assist:  Yes  No

Backoff Period:  seconds

Roaming Threshold:  dB

Minimum Data Rate:  Mbps

Device Classes

Appliance  Game  Notebook  Phone  Player

Tablet

Device Types

Android  AppleTV  Archos  BlackBerry  Danger

DirecTV  DoCoMo  Ericsson  GoogleTV  KDDI

Devices:

Kindle  Linux  Mac  Nintendo  Nokia

PalmOS  PlayStation  Samsung  Symbian  Thermostat

Vodafone  WebOS  Wii  Win Mobile  Windows

Xbox  iPad  iPhone  iPod  phone

tablet  player

Custom:

Figure 183. Roaming Assist

### *Procedure for Configuring Roaming Assist*

1. **Enable Roaming Assist:** Use the **Yes** and **No** buttons to enable or disable this feature.
2. **Backoff Period:** After deauthenticating a station, it may re-associate to the same radio. To prevent the AP from repeatedly deauthenticating the station when it comes back, there is a backoff period. This is the number of seconds the station is allowed to stay connected before another deauthentication.
3. **Roaming Threshold:** This is the difference in signal strength between radios that will trigger a deauthentication, as described in the discussion above. In most cases, this will be a negative number. Triggering occurs regardless of whether the data rate falls below the Minimum Data Rate.
4. **Minimum Data Rate:** Roaming assist will be triggered if the station's packet data rate is below this value (1-99 Mbps), regardless of whether the Roaming Threshold has been reached.

- 5. Device Classes:** If you select any classes of device, such as **Phone** and **Notebook**, then roaming assist will *only* be applied to those kinds of stations. Many small, embedded devices (such as phones, tablets, and music players) are sticky—they have high roaming thresholds that tend to keep them attached to the same radio despite the presence of radios with better signal strength. You may check off one or more entries, but use care since roaming assist may cause poor results in some cases.

If no Device Classes or Device Types are selected, then all devices are included in roaming assist. If you select entries in both Device Classes and Device Types, then stations matching any of your selected types/classes will be assisted when the Roaming Threshold or Minimum Data Rate trigger is satisfied.

- 6. Device Types:** If you select any types of device, such as **iPhone** and **Samsung**, then roaming assist will *only* be applied to those types of stations and to your selected Device Types as well, when the Roaming Threshold or Minimum Data Rate trigger is satisfied. If no Device Classes or Device Types are selected, then all devices are considered for roaming assist.

## WDS

This is a status-only window that provides an overview of all WDS links that have been defined. Wireless Distribution System (WDS) is a system that enables the interconnection of access points wirelessly, allowing your wireless network to be expanded using multiple access points without the need for a wired backbone to link them. The **Summary of WDS Client Links** shows the WDS links that you have defined on this AP and identifies the target AP for each by its base MAC address. The **Summary of WDS Host Links** shows the WDS links that have been established on this AP as a result of client APs associating to this AP (i.e., the client APs have this AP as their target). The summary identifies the source (client) AP for each link. Both summaries identify the IAPs that are part of the link and whether the connection for each is up or down. See “[WDS Planning](#)” on page 67 for an overview.

Summary of WDS Client Links								
Link	State	Max IAPs	Target Array	Target SSID	Distance	IAP(s)	Channel(s)	Connection(s)
1	Off	1						
2	Off	1						
3	Off	1						
4	Off	1						

Summary of WDS Host Links								Host Link Stations: not
Link	State	Num IAPs	Source Array	Source SSID	Distance	IAP(s)	Channel(s)	Connection(s)
1	Off							
2	Off							
3	Off							
4	Off							

Figure 184. WDS

### About Configuring WDS Links

A WDS link connects a client AP and a host AP (see [Figure 185 on page 392](#)). The host must be the AP that has a wired connection to the LAN. Client links from one or more APs may be connected to the host, and the host may also have client links. See “[WDS Planning](#)” on page 67 for more illustrations.

The configuration for WDS is performed on the client AP only, as described in “[WDS Client Links](#)” on page 394. No WDS configuration is performed on the host AP. First you will set up a client link, defining the target (host) AP and SSID, and the maximum number of IAPs in the link. Then you will select the IAPs to be used

in the link. When the client link is created, each member IAP will associate to a radio on the host AP.

You may wish to consider configuring the WDS link IAPs so that only the WDS link SSIDs are active on them. See “Active IAPs” on page 304.

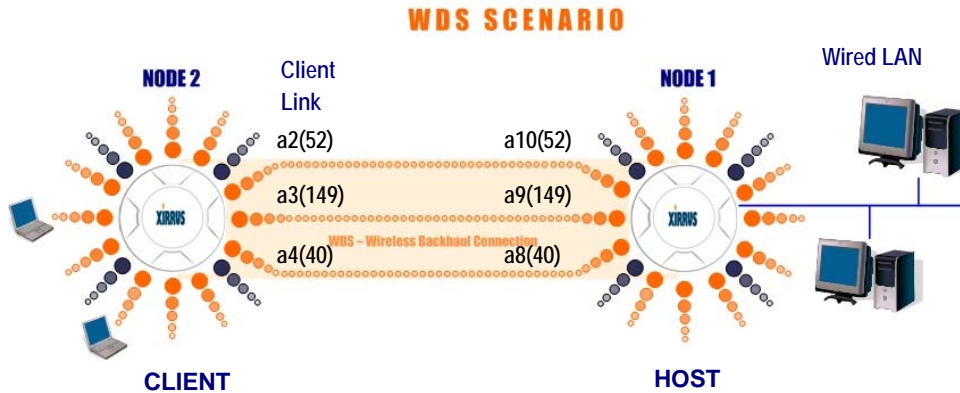

Figure 185. Configuring a WDS Link



Using WDS between different families of APs (e.g., WDS between an XD AP and an XR AP, or between Wave 1 and Wave 2 XD APs) is not recommended. If you must create a link between different radio types, set the most advanced AP type as the host.



Once some IAP has been selected to act as a WDS client link, you will not be allowed to use auto-configured cell sizing on that IAP (since the cell must extend all the way to the other AP).



When configuring WDS, if you use WPA-PSK (Pre-Shared Key) as a security mechanism, ensure that EAP is disabled. Communication between two APs in WDS mode will not succeed if the client AP has both PSK and EAP enabled on the SSID used by WDS. See **SSID Management**.



TKIP encryption does not support high throughput rates, per IEEE 802.11n. TKIP should **never** be used for WDS links on APs.



*WDS is available on most Riverbed APs, including models with two radios (WDS will operate on either of the radios). If WDS is not available, the settings are grayed out or not shown.*

### Long Distance Links

If you are using WDS to provide backhaul over an extended distance, use the **WDS Dist. (Miles)** setting to prevent timeout problems associated with long transmission times. (See [“IAP Settings” on page 319](#)) Set the approximate distance in miles between this IAP and the connected AP in the **WDS Dist. (Miles)** column. This will increase the wait time for frame transmission accordingly.

#### *See Also*

[SSID Management](#)

[Active IAPs](#)

[WDS Client Links](#)

[WDS Statistics](#)

## WDS Client Links

This window allows you to set up a maximum of four WDS client links.

Logged in as: admin

Host Link Stations:  Allow

Roaming RSSI Threshold:  dB

Roaming RSSI Averaging Weight:

Client Link	Enable	Max IAPs Allowed	Target Array Base MAC Address	Target SSID	Username	Password	Apply Settings	Clear Settings
1	<input type="checkbox"/>	<input type="text" value="1"/>	<input type="text"/>	<input type="text"/>	<input type="text"/>	<input type="text"/>	<input type="button" value="Apply"/>	<input type="button" value="Clear"/>
2	<input type="checkbox"/>	<input type="text" value="1"/>	<input type="text"/>	<input type="text"/>	<input type="text"/>	<input type="text"/>	<input type="button" value="Apply"/>	<input type="button" value="Clear"/>
3	<input type="checkbox"/>	<input type="text" value="1"/>	<input type="text"/>	<input type="text"/>	<input type="text"/>	<input type="text"/>	<input type="button" value="Apply"/>	<input type="button" value="Clear"/>
4	<input type="checkbox"/>	<input type="text" value="1"/>	<input type="text"/>	<input type="text"/>	<input type="text"/>	<input type="text"/>	<input type="button" value="Apply"/>	<input type="button" value="Clear"/>

WDS Client Link IAP Assignments

WDS Link	IAP / Channel							
	iap1 mon	iap2 36+40	iap3 1	iap4 44+48	iap5 149+153	iap6 52+56	iap7 11	iap8 60+64
Client Link 1	<input type="radio"/>	<input type="radio"/>	<input type="radio"/>	<input type="radio"/>	<input type="radio"/>	<input type="radio"/>	<input type="radio"/>	<input type="radio"/>
Client Link 2	<input type="radio"/>	<input type="radio"/>	<input type="radio"/>	<input type="radio"/>	<input type="radio"/>	<input type="radio"/>	<input type="radio"/>	<input type="radio"/>
Client Link 3	<input type="radio"/>	<input type="radio"/>	<input type="radio"/>	<input type="radio"/>	<input type="radio"/>	<input type="radio"/>	<input type="radio"/>	<input type="radio"/>
Client Link 4	<input type="radio"/>	<input type="radio"/>	<input type="radio"/>	<input type="radio"/>	<input type="radio"/>	<input type="radio"/>	<input type="radio"/>	<input type="radio"/>
None	<input type="radio"/>	<input type="radio"/>	<input type="radio"/>	<input type="radio"/>	<input type="radio"/>	<input type="radio"/>	<input type="radio"/>	<input type="radio"/>

IAP Channel Assignment:

Figure 186. WDS Client Links

### Procedure for Setting Up WDS Client Links



*It is VERY important to use the WDS Lock command in CLI if you are using WDS and your network is being managed by any version of XMS, because XMS does not manage WDS or take it into consideration. When XMS applies configuration changes, it resets the AP's configuration before applying the new configuration, and this can sever WDS links. To prevent this, see "interface" on page 477 for the WDS Lock CLI command.*

1. See the note above to use the WDS Lock command if your network is being managed by any version of XMS.
2. **Host Link Stations:** Check the **Allow** checkbox to instruct the AP to allow stations to associate to IAPs on a host AP that participates in a WDS link. The WDS host IAP will send beacons announcing its availability to wireless clients. This is disabled by default.



*Once some IAP has been selected to act as a WDS client link, no other association will be allowed on that IAP. However, wireless associations will be allowed on the WDS host side of the WDS session.*



*In situations like the one in the next step, where WDS is used by an AP mounted on a high speed train, STP can add significant delay (often on the order of 30 to 60 seconds) while initially analyzing network topology. In such a situation, it may be desirable to disable STP. See “Management Control” on page 243.*



*Caution: If Spanning Tree Protocol (“Management Control” on page 243) is disabled and a network connection is made on the WDS Client AP’s Gigabit link that can reach the WDS Host AP, broadcast and multicast packets will not be blocked. A broadcast storm may cause a network outage.*

3. **Roaming RSSI Threshold:** If an AP is deployed on a mobile site (on a train, for example), you can use WDS to implement a wireless backhaul that will roam between APs at fixed locations. When another candidate AP for WDS host target is found, the client link will roam to the new AP if its RSSI is stronger than the RSSI of the current host connection by at least the **Roaming RSSI Threshold**. The default is 6 dB.
4. **Roaming RSSI Averaging Weight:** This weight changes how much the latest RSSI reading influences the cumulative weighted RSSI value utilized in checking the threshold (above) to make a roaming decision. The higher the weight, the lower the influence of a new RSSI reading. This is not exactly a percentage, but a factor in the formula for computing the current RSSI value based on new readings:

$$\text{StoredRSSI} = (\text{StoredRSSI} * \text{RoamingAvgWeight} + \text{NewRSSIReading} * (100 - \text{RoamingAvgWeight})) / 100$$

This prevents erroneous or out-of-line RSSI readings from causing the WDS link to jump to a new AP. Such readings can result from temporary obstructions, external interference, etc.

5. Click the **Save** button  after you are finished making changes on this page if you wish to make your changes permanent.

### WDS Client Link Setting:

6. **Enable/Disable/Reset All Links:** Click the appropriate button to:
  - **Enable All Links**—this command activates all WDS links configured on the AP.
  - **Disable All Links**—this command deactivates all WDS links configured on the AP. It leaves all your settings unchanged, ready to re-enable.
  - **Reset All Links**—this command tears down all links configured on the AP and sets them back to their factory defaults, effective immediately.
7. **Client Link:** Shows the ID (1 to 4) of each of the four possible WDS links.
8. **Enabled:** Check this box if you want to enable this WDS link, or uncheck the box to disable the link.
9. **Max IAPs Allowed (1-3):** Enter the maximum number of IAPs for this link, between 1 and 3.
10. **Target AP Base MAC Address:** Enter the base MAC address of the target AP (the host AP at the other side of this link). To find this MAC address, open the **WDS** window on the *target* AP, and use **This AP Address** located on the right under the Summary of WDS Host Links. To allow any Riverbed AP to be accepted as a WDS target, enter the Riverbed OUI: **00:0f:7d:00:00:00** or **50:60:28:00:00:00** (this is useful for roaming in a mobile deployment, as described in [Step 3 on page 395](#)).
11. **Target SSID:** Enter the SSID that the target AP is using.



12. **Username:** Enter a username for this WDS link. A username and password is required if the SSID is using PEAP for WDS authentication from the internal RADIUS server.
13. **Password:** Enter a password for this WDS link.
14. **Clear Settings:** Click on the **Clear** button to reset all of the fields on this line.

### WDS Client Link IAP Assignments:

15. For each desired client link, select the IAPs that are part of that link. The IAP channel assignments are shown in the column headers.
16. **IAP Channel Assignment:** Click **Auto Configure** to instruct the AP to automatically determine the best channel allocation settings for each IAP that participates in a WDS link, based on changes in the environment. These changes are executed immediately, and are automatically applied.

### *See Also*

[SSID Management](#)

[WDS Planning](#)

[WDS](#)

[WDS Statistics](#)

## Filters

The Wireless AP's integrated firewall uses stateful inspection to speed the decision of whether to allow or deny traffic. Filters are used to define the rules used for blocking or passing traffic. Filters can also change the destination IP address, VLAN, and/or QoS level for selected traffic.



*The air cleaner feature offers a number of predetermined filter rules that eliminate a great deal of unnecessary wireless traffic. See “Air Cleaner” on page 473.*

Filters may be used based on your experience with [Application Control Windows](#) to eliminate or cap the amount of traffic allowed for less desirable applications.

Global Filter & IDS Settings											
Stateful Filtering		enabled									
Application Control		disabled									
Filter Summary											
List Name	List Enabled	Filter Name	Priority	Enabled	Type	Log	Layer	Protocol	Port	Source	Des
- FilterList1 - 1 item(s)											
FilterList1	disabled	Filter1a	1	disabled	deny	disabled	3	igmp	chargen		
+ Global - 14 item(s)											
Application Lists											
List Name	Application										
No rows to display.											

Figure 187. Filters

User connections managed by the firewall are maintained statefully—once a user flow is established through the AP, it is recognized and passed through without application of all defined filtering rules. Stateful inspection runs automatically on the AP. The rest of this section describes how to view and manage filters.

Filters are organized in groups, called Filter Lists. A filter list allows you to apply a uniform set of filters to [SSIDs](#) or [Groups](#) very easily. Similarly, you can use [Filters](#) to create a set of applications that are handled as a group for convenience when creating filters.

The read-only Filters window provides you with an overview of all filter lists and Application Control lists that have been defined for this AP, and the filters that

have been created in each list. Filters are listed in the left side column by name under the filter list to which they belong. Each filter entry is a link that takes you to its [Filters](#) entry, and the list includes information about the type of filter, the protocol it is filtering, which port it applies to, source and destination addresses, and QoS and VLAN assignments.

### Filter Management

This window allows you to enable or disable stateful filtering and [Application Control](#), and create filter lists and filters. Filter lists offer you ease of management of groups of filters. The AP comes with one predefined filter list, named **Global**, which cannot be deleted. Filter lists (including Global) may be applied to [SSIDs](#) or to [Groups](#). Only one filter list at a time may be applied to a group or SSID (although the filter list may contain a number of filters). All filters are created within filter lists.

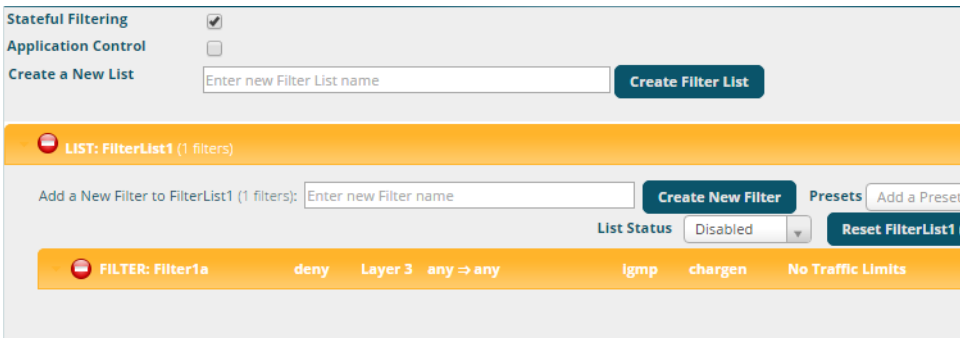

Figure 188. Filter Lists

### *Procedure for Managing Filter Lists*

1. **Stateful Filtering:** Stateful operation of the integrated firewall can be **Enabled** or **Disabled**. If you have many filters and you don't want to apply them in a stateful manner, use this option to turn the firewall off.
2. **Application Control:** Operation of the Application Control feature may be **Enabled** or **Disabled**. See [“Application Control Windows” on page 154](#).



*The Application Control feature is only available if the AP license includes **Application Control**. If a setting is unavailable (grayed out), then your license does not support the feature. See “**About Licensing and Upgrades**” on page 412.*

3. **Create a New List:** Enter a name for the new filter list in this field, then click **Create Filter List**. The new filter list is displayed alphabetically on the page and is initially disabled. Click this new entry to expand it and begin adding filters to it as described in [Filters](#). You may create up to 16 filter lists (up to 8 on the XR-500 Series).
4. **List Status:** Use this to enable or disable this filter list. If the list is disabled, you may still add filters to it or modify it, but none of the filters will be applied to data traffic.
5. **Filters:** This read-only field displays the number of filters that belong to this filter list.
6. **Delete:** Click this button to delete this filter list. The **Global** filter list may not be deleted.

## Filters

These settings create and manage filters that belong to the current filter list, based on the filter criteria you specify. Filters are an especially powerful feature when combined with the intelligence provided by the “[Application Control Windows](#)” on page 154.

Based on Application Control’s analysis of your wireless traffic, you can create filters to enhance wireless usage for your business needs:

- Usage of non-productive and risky applications like BitTorrent can be restricted.
- Traffic for mission-critical applications like VoIP and WebEx may be given higher priority (QoS).
- Non-critical traffic from applications like YouTube may be given lower priority (QoS) or bandwidth allowed may be capped per station or for all stations.

## Wireless Access Point

- Traffic flows for specific applications may be controlled by sending them into VLANs that are designated for that type of traffic.
- Filters may be applied at specified times—for example, no games allowed from 8 AM to 6 PM.

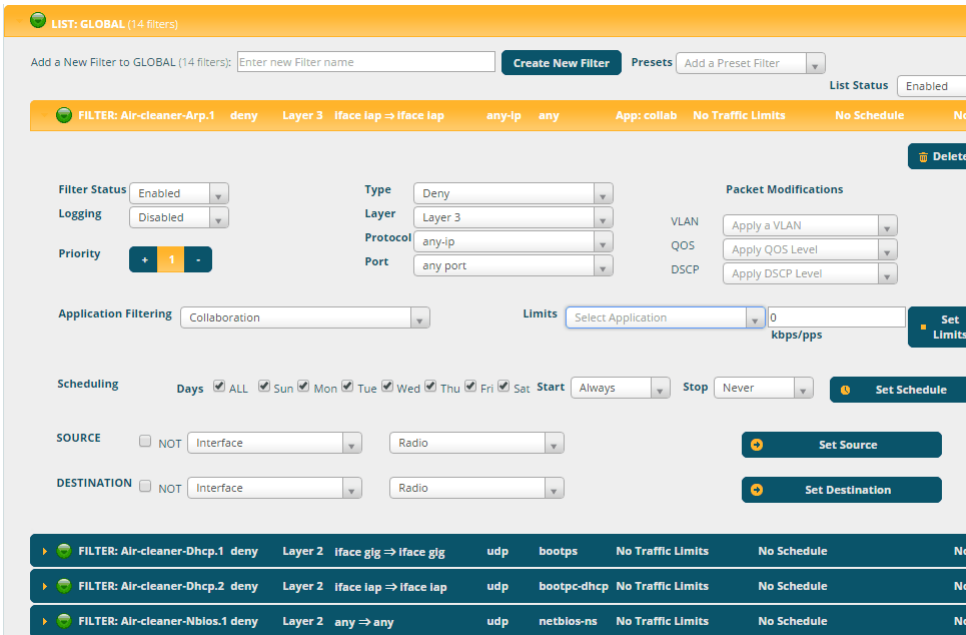

Figure 189. Filters

Note that filtering is secondary to the stateful inspection performed by the integrated firewall. Traffic for established connections is passed through without the application of these filtering rules.

### Procedure for Managing Filters

1. Select the desired filter list. All of the filters already defined for this list are shown, and you may create additional filters for this list. You may create up to 50 filters per list (up to 25 per list on the XR-500 Series).

2. **Presets:** A number of predefined “Air Cleaner” filters are available by selecting from the drop-down list. You can use these rules to eliminate a great deal of unnecessary wireless traffic, resulting in improved performance. Web Access Only may be selected to allow only web access protocols to be used. For more information, please see “Air Cleaner” on [page 473](#). When you select one of the filter presets, the appropriate filters will be added to the list, so that you can see exactly what settings have been used.
3. **Add a New Filter:** To add a new filter, enter its name here and click **Create New Filter**. All new filters are added to the table of filters in the window. The filter name must be unique within the list, but it may have the same name as a filter in a different filter list. Two filters with the same name in different filter lists will be completely unrelated to each other—they may be defined with different parameter values.

Viewing or modifying existing filter entries:

4. **Filter:** Click a filter entry if you wish to modify it. Source and destination details are displayed below the bottom of the list.
5. To delete a filter, click its **Delete** button.
6. **Filter Status:** Use this field to enable or disable this filter.
7. **Logging:** Log usage of this filter to Syslog.
8. **Priority:** The filters are applied in the order in which they are displayed in the list, with filters on the top applied first. To change an entry’s position in the list, just click its + or - button.
9. **Type:** Choose whether this filter will be an **Allow** filter or a **Deny** filter. If you define the filter as an Allow filter, then any traffic that meets the filter criteria will be allowed. If you define the filter as a Deny filter, any traffic that meets the filter criteria will be denied.
10. **Layer:** Select network layer 2 or 3 for operation of this filter.

11. **Protocol:** Choose a specific filter protocol from the pull-down list, or choose **any** to instruct the AP to use the best filter. This is a match criterion.
12. **Port:** This is a match criterion. From the pull-down list, choose the target port type for this filter. Choose **any** to instruct the AP to apply the filter to any port.



*The next three settings (VLAN, QoS, and DSCP) allow you to modify packets. You may also change the destination address of packets that match the filter criteria to a specified IP address via CLI only. See “filter” on page 472, and use the **set-ip** setting. This may be used for applications such as content filtering, URL filtering, or DNS redirection, for example.*

13. **VLAN:** (Optional) Set packets that match the filter criteria to this VLAN. Select a VLAN from the pull-down list (see “VLANs” on page 217).
14. **QoS:** (Optional) Set packets ingressing from the wired network that match the filter criteria to this QoS level (0 to 3) before sending them out on the wireless network. Select the level from the pull-down list. Level 0 has the lowest priority; level 3 has the highest priority. By default, this field is blank and the filter does not modify QoS level. Use the **clear** option at the bottom of this list if you wish to clear this setting. See “Understanding QoS Priority on the Wireless AP” on page 277.
15. **DSCP:** Differentiated Services Code Point or DiffServ (DSCP) —Optional. Set packets ingressing from the wireless network that match the filter criteria to this DSCP level (0 to 63) before sending them out on the wired network. Select the level from the pull-down list. Level 0 has the lowest priority; level 63 has the highest priority. By default, this field is blank and the filter does not modify DSCP level. Use the **clear** option at the bottom of this list if you wish to clear this setting. See “Understanding QoS Priority on the Wireless AP” on page 277.
16. **Application Filtering:** There are three options for specifying applications:
  - a. Select a [Custom Application List](#) from the top of the drop-down list. All applications in that list will match this filter. If you wish to match

multiple applications, the Custom Application List is the best way to handle this.

- b. Select a category of applications near the top of the drop-down list. All applications that fit that category will match this filter
- c. Select a specific application from the drop-down list. To narrow down the list, enter a string. All entries that include that string in any position will be listed.

If an application has been selected, you should not enter **Protocol** or **Port**—application filters have intelligence built into them, and perform filtering that you cannot accomplish with just port and protocol. See [“Application Control Windows” on page 154](#).

- 17. **Limits:** Instead of simply allowing/denying the specified traffic type, you may cap the amount of traffic allowed that matches this filter. First choose the units for the limit: kbps for all stations in total or per station, or packets per second (pps) for all stations in total or per station. Enter the numeric limit in the field to the left, then click **Set Limits**.
- 18. **Scheduling:** Use these fields if you wish to specify a scheduled time for this filter to be active. Check the checkboxes for the days that the filter is to be active. By default, the filter is active all day on each selected day. You may also specify a time of day for the filter to be active by entering a **Start** and **Stop** time in 24:00 hour format (i.e., 6:30 PM is 18:30). To use this feature, you must enter both a Start and a Stop time. Click **Set Schedule** when done.

You cannot apply one filter for two or more scheduled periods, but you can create two filters to achieve that. For example, one filter could deny the category Games from 9:00 to 12:00, and another could deny them from 13:00 to 18:00. Similarly, you might create two rules for different days—one to deny Games Mon-Fri 8:00 to 18:00, and another to deny them on Sat. from 8:00 to 12:00.



- 19. Source:** Define a source address to match as a filter criterion. Select the desired type of address (or other attribute) to match. Then specify the value to match in the field to the right. Choose **Any** to use any source address. Check **Not** to match any address except for the specified address. Click **Set Source** when done.

Where appropriate, the filter takes into account the Riverbed wireless network, rather than just considering this AP. For example, to block station-to-station traffic within an SSID, set the Source and Destination to the desired SSID and set the Type to Deny. This will block traffic between stations that are both on the specified SSID, even if one of the stations is associated to that SSID on a different AP.

- 20. Destination:** Define a destination address to match as a filter criterion. Select the desired type of address (or other attribute) to match. Then specify the value to match in the field to the right. Choose **Any** to use any destination address. Check **Not** to match any address except for the specified address. Click **Set Destination** when done.
- 21.** Click the **Save** button  if you wish to make your changes permanent.

### *See Also*

[Filters](#)

[Filter Statistics](#)

[Understanding QoS Priority on the Wireless AP](#)

[VLANs](#)

### **Custom Application List**

Use a custom Application Control list to create a set of applications to be handled as a group when creating filters. This way, one filter can apply to an entire group of applications. This keeps the number of filters down and makes them much easier to manage. For example, you can include BitTorrent, Netflix, and Fox Sports in an Application Control list, and then create a single filter to block all three during business hours.

---

### *Custom Application Control List*

1. **Create New List:** Enter a name for the new Application Control list in this field, then click **Create List**. The new list is added to the Application Control Lists table, and this list may be used to create filters. You may create up to 15 lists (on the XR-520, the limits are reduced to 8 lists and 125 applications per list).

Click in the field for the new entry to display a list of applications. Add the desired applications to this list, one at a time. Up to 250 applications may be added. This field also provides a search feature—type in a string, and the list will display only the choices whose names contain that string in any position. Click the **Apply** button on the right when done adding applications to this list.

Click **Reset** if you want to remove all of the entries from this field, i.e., to empty it. Click **Remove** to delete this Application Control list. You may use **Reset All Lists** on the bottom to delete all lists.

2. Click the **Save** button  if you wish to make your changes permanent.

## Mobile

Mobile Device Management (MDM) servers enable you to manage large-scale deployments of mobile devices. They may include capabilities to handle tasks such as enrolling devices in your environment, configuring and updating device settings over-the-air, enforcing security policies and compliance, securing mobile access to your resources, and remotely locking and wiping managed devices.

Riverbed APs support the AirWatch MDM, using an AirWatch API call to determine the status of a user’s device and allow access to the wireless network only if the device is enrolled and compliant with the policies of the service.

## AirWatch

Individual SSIDs may be configured to require AirWatch enrollment and compliance before a mobile device such as a smartphone or tablet is admitted to the wireless network. The AP uses the AirWatch API with the settings below to request that AirWatch check whether the mobile device is enrolled and compliant with your wireless policies.

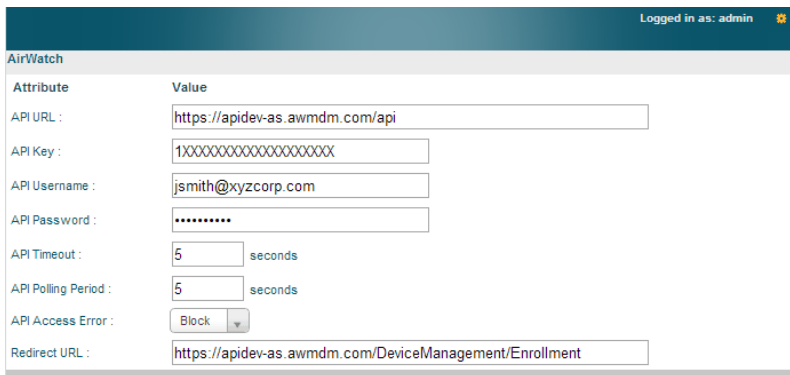

The screenshot shows a configuration page for AirWatch. At the top right, it says "Logged in as: admin". The page title is "AirWatch". Below the title is a table with two columns: "Attribute" and "Value".

Attribute	Value
API URL :	<input type="text" value="https://apidev-as.awmdm.com/api"/>
API Key :	<input type="text" value="1XXXXXXXXXXXXXXXXXXXX"/>
API Username :	<input type="text" value="jsmith@xyzcorp.com"/>
API Password :	<input type="password" value="*****"/>
API Timeout :	<input type="text" value="5"/> seconds
API Polling Period :	<input type="text" value="5"/> seconds
API Access Error :	<input type="button" value="Block"/>
Redirect URL :	<input type="text" value="https://apidev-as.awmdm.com/DeviceManagement/Enrollment"/>

Figure 190. AirWatch Settings

Before configuring AirWatch settings on the AP, you must have an AirWatch account, already set up with your organization’s compliance policies and other configuration as required by AirWatch.

The AP settings entered on this page are mostly taken from AirWatch. Once you have entered these settings, your users will be constrained to follow a set of steps to access the wireless network, as described in [“User Procedure for Wireless Access” on page 409](#).

### *Procedure for Managing AirWatch*

If you have configured the **Mobile Device Management** setting on one or more SSIDs to use **AirWatch**, then the API specified below will be used to determine the admissibility of a mobile device requesting a connection to the wireless network.

1. **API URL:** Obtain this from your AirWatch server’s **System / Advanced / Site URLs** page. Copy the **REST API URL** string into this field. This specifies the AirWatch API that the AP will call to determine the enrollment and compliance status of a mobile device attempting to connect to the AP. The steps that the user will need to take are described in [“User Procedure for Wireless Access” on page 409](#).
2. **API Key:** Obtain this from your AirWatch server. Go to the **System / Advanced / API / REST** page, **General** tab, and copy the **API Key** string into this field. The key is required for access to the API.
3. **API Username:** Enter the user name for your account on the AirWatch server.
4. **API Password:** Enter the password for your account on the AirWatch server.
5. **API Timeout:** (seconds) If AirWatch does not respond within this many seconds, the request fails.
6. **API Polling Period:** (seconds) Mobile device enrollment and compliance status will be checked via polling at this interval. Note that there may thus be a delay before the mobile device will be admitted.
7. **API Access Error:** Specify whether or not to allow access if AirWatch fails to respond. The default is to **Block** access.

8. **Redirect URL:** Obtain this from your AirWatch server. Go to the **System / Advanced / Site URLs** page, and copy the **Enrollment URL** string into this field. When a mobile device that is not currently enrolled with AirWatch attempts to connect to the AP, the device displays a page directing the user to install the AirWatch agent and go to the AirWatch enrollment page. Note that Android devices will need another form of network access (i.e. cellular) to download the agent, since un-enrolled devices will not have access to download it via the AP. See [“User Procedure for Wireless Access” on page 409](#) for more details.
9. You must configure the **Mobile Device Management** setting on one or more SSIDs to use **AirWatch**, as described in [Procedure for Managing SSIDs](#) (see [Step 17 on page 289](#)).

### User Procedure for Wireless Access

1. A user attempts to connect a mobile device to an SSID that uses AirWatch.
2. The device will authenticate according to the SSID’s authentication settings (Open, Radius MAC, 802.1x).
3. The user browses to any destination on the Internet.

The AP asks the user to wait while it checks device enrollment and compliance status by querying the AirWatch API with the device MAC address.



*Device enrollment and compliance status will be checked via polling so there may be a delay before the device will be allowed in. That delay will depend on the API Polling Period setting.*

4. If AirWatch responds that the device is enrolled and compliant, the device will be allowed into the network. The device will be considered compliant if AirWatch finds that the device does not violate any applicable policies for that device. (If no policies are assigned to the device in AirWatch, then the device is compliant by default.)

5. If the device is not enrolled, all user traffic will be blocked, except that HTTP traffic is redirected to an intermediate page on the AP that tells the user to download and install the AirWatch agent. The page displays a link to the AirWatch-provided device enrollment URL. This link is a pass-through that allows the user to go through the enrollment process. The user will need to enter your organization's AirWatch Group ID and individual account credentials when requested.

Once the agent is installed, the user must start again at [Step 1](#).



*Android devices must go to the PlayStore to install the agent BEFORE they can go through the enrollment process. This means un-enrolled devices need another form of network access (i.e., cellular or an unrestricted SSID) to download this agent, as they are not permitted access to the PlayStore.*

*Once the agent is installed, the user must start again at [Step 1](#).*

6. If the device is enrolled with AirWatch but not compliant with applicable policies, all traffic will be blocked as in [Step 5](#) above, and the HTTP traffic will be redirected to an intermediate page on the AP that tells the user which policies are out of compliance.

This page contains a button for the user to click when the compliance issues have been corrected. This button causes AirWatch to again check device compliance. The user's browser is redirected to a "wait" page until the AP has confirmed compliance with AirWatch. The user's browser is then redirected to a page announcing that the device is now allowed network access.

If the AP is unable to access AirWatch to obtain enrollment and compliance status (for example, due to bad credentials, timeout, etc.), device access to the network will be granted according to the **API Access Error** setting (**Allow** or **Block**). If this field is set to **Block**, traffic will be blocked as in [Step 5](#) above and HTTP traffic will be redirected to an informational page that informs the user that AirWatch cannot be contacted at this time and advises the user to contact the network administrator. If this field is set to **Allow**, then the device will be allowed network access.

# Using Tools on the Wireless AP

These WMI windows allow you to perform administrative tasks on your AP, such as upgrading software, rebooting, uploading and downloading configuration files, and other utility tasks. Tools are described in the following sections:

- **“System Tools” on page 412**
- **“CLI” on page 427**
- **“API Documentation” on page 429**
- **“Options” on page 434**
- **“Logout” on page 435**



*If you have added modular IAPs to your AP, note that its model number will be automatically adjusted to reflect the count and types of IAPs currently installed. See **Upgrading with 802.11ac radio modules**.*

This section does not discuss using status or configuration windows. For information on those windows, please see:

- **“Viewing Status on the Wireless AP” on page 99**
- **“Configuring the Wireless AP” on page 165**

## System Tools

**System** Current Version: 7

License Key:

Operating System Software Upload:  No file chosen

Active Software Image:

Remove a Software Image:

Reboot:   Delay  seconds

- ^ Remote Boot Services
- ^ Configuration Management
- ^ Diagnostics
- ^ Application Control Signature File
- ^ Web Page Redirect
- ^ Network Tools

**STATUS**

← **Status is shown here**

Figure 191. System Tools

This window allows you to manage files for software images, configuration, and Web Page Redirect (WPR), manage the system’s configuration parameters, reboot the system, and use diagnostic tools. The page contains a number of sections that you may expand.

### About Licensing and Upgrades

If you are a customer using XMS, when you upgrade an AP using XMS, your license will automatically be updated for you first.

The AP’s license determines some of the features that are available on the AP. For example, the Application Control feature is an option that must be separately licensed. To check the features supported by your license, see [“Access Point Information” on page 106](#).



When upgrading the AP for a new major release, the AP needs the new license key that enables the operation of that release before upgrading. If you do not obtain the new license first, the AP will display a message and revert to the previous software image, rather than trying to run new software for which it is not licensed. Major releases will need a new license key, but minor releases will not. For example, to upgrade from ArrayOS Release 7.0.5 to Release 7.1, you must enter a new license key. To upgrade from ArrayOS Release 7.0.1 to Release 7.0.3, use your existing license key.

If you are not using XMS to perform a software upgrade, you may use the **Auto-provisioning Start** button to get an updated license from Riverbed before performing an upgrade. See [“Configuration Management” on page 418](#).

If you will be entering license keys and performing upgrades on many APs, the effort will be streamlined by using the Xirrus Management System (XMS), especially if you are using XMS Cloud.

### *Steps for Upgrading the AP*

Follow these steps to upgrade an AP using the WMI.

1. Verify that your license supports the new release. See [“Access Point Information” on page 106](#). If not, obtain a new license by contacting Riverbed Customer Support. Install it using [Step 1 on page 414](#).
2. Upload the new software image to the AP using [Step 2 on page 415](#).
3. After the upload is successful, set the new image to be the currently active image using [Step 3 on page 416](#).
4. Save and reboot using [Step 5 on page 416](#).
5. Get rid of any unneeded images using [Step 4 on page 416](#).

---

## *Procedure for Configuring System Tools*

These tools are broken down into the following sections:

- **System**
- **Remote Boot Services**
- **Configuration Management**
- **Diagnostics**
- **Application Control Signature File Management**
- **Web Page Redirect (Captive Portal)**
- **Network Tools**
- **Progress Bar and Status Frame**

### **System**

Note that the top line of this section shows the current software version running on the AP. See [Figure 191](#).

#### **1. License Key**



*If you are a customer using XMS-Cloud, your license will be updated for you automatically; with other XMS versions, you can easily upgrade all members of a profile network to a new ArrayOS release, including updating license keys.*

If you need an updated license (for example, if you are upgrading an AP to a new major release—say, from 7.0 to 7.1, and you are not using XMS to perform network-wide updates), you may obtain one through **Auto-provisioning**. See [“Configuration Management”](#) on page 418.

If you need to enter a new license key manually, use the **License Key** field to enter it, then click the **Apply** button to the right.

A valid license is required for AP operation, and it controls the features available on the AP. If you upgrade your AP for additional features, you will be provided with a license key to activate those capabilities.

A license update will automatically save a copy of the current configuration of the AP. See [Step 3 on page 418](#).

If you attempt to enter an invalid key, you will receive an error message and the current key will not be replaced.



*Trial licenses: If you enter a trial license to try new premium features, then when the trial expires the perpetual license will be restored automatically without requiring a reboot. When the trial expires, the current AP configuration will not be lost.*

2. **Operating System Software Upload:** (Note that “[Steps for Upgrading the AP](#)” on [page 413](#) describes using this setting and those below for upgrading the AP using the WMI.)

This feature upgrades the ArrayOS to a newer version provided by Riverbed. **Please note that you typically will need an updated license key to cover the upgrade’s features before clicking the Upgrade button.** For customers using XMS-Cloud, your license will be updated for you automatically; with other XMS versions, you can easily upgrade all members of a profile network to a new ArrayOS release. See “[About Licensing and Upgrades](#)” on [page 412](#) for details. Click the **Choose File** button to locate the software upgrade file, then click on the **Upload** button to upload the new file to the AP. Progress of the operation will be displayed in a progress bar. Completion status of the operation is shown in the **Status** section.

This operation does not run the new software or change any configured values. The existing software continues to run on the AP until you reboot, at which time the uploaded software will be used. An upgrade will, however, automatically save a copy of the current configuration of the AP. See [Step 3 on page 418](#).



If you have difficulty upgrading the AP using the WMI, see [“Upgrading the AP Using the Boot Loader”](#) on page 551 for a lower-level procedure you may use.

Software Upgrade always uploads the file in binary mode. If you transfer any image file to your computer to have it available for the Software Upgrade command, it is **critical** to remember to transfer it (ftp, tftp) in **binary mode!**

3. **Active Software Image:** Use the **Set Active Image** drop-down list to display all of the software versions that are on your AP. Select the version from the list that you would like to become the active version the next time that you reboot.
4. **Remove a Software Image:** Use the **Set Image to remove** drop-down list to display all of the software versions that are on your AP. Select a version from the list to remove it. *Note that there is no Apply button for this—the image is removed with no further action on your part.*
5. **Save & Reboot** or **Reboot:** Use **Save & Reboot** to save the current configuration and then reboot the AP. The AP will reboot using the software version that you have selected in **Active Software Image**, above. The LEDs on the AP indicate the progress of the reboot, as described in [“Powering Up the Wireless AP”](#) on page 76. Alternatively, use the **Reboot** button to discard any configuration changes which have not been saved since the last reboot. You may specify an optional **Delay** period in seconds to wait before the reboot starts.

## Remote Boot Services

(Automatic updates from remote image or configuration file)

Remote Boot Services	
Remote TFTP Server:	<input type="text"/>
Remote Boot Image:	<input type="text"/>
Remote Configuration:	<input type="text"/>

Figure 192. Remote Boot Services

The AP software image or configuration file can be downloaded from an external server. In large deployments, all APs can be pointed to one TFTP server instead of explicitly initiating software image uploads to all APs. When the AP boots, the AP will download the software image from the specified TFTP server. Similarly, if you decide to change a setting in the APs, you can simply modify a single configuration file. After the APs are rebooted, they will automatically download the new configuration file from a single location on the specified TFTP server.

1. **Remote TFTP Server:** This field defines the path to a TFTP server to be used for automated remote update of software image and configuration files when rebooting. You may specify the server using an IP address or host name.
2. **Remote Boot Image:** When the AP boots up, it fetches the software image file specified here from the TFTP server defined above, and upgrades to this image before booting. This must be an AP image file with a **.bin** extension.

Make sure to place the file on the TFTP server. If you disable the remote boot image (by blanking out this field) or if the image can't be transferred, the AP will fall back to booting whatever image is on the compact flash.



*The Remote Boot Image or Remote Configuration update happens every time that the AP reboots. If you only want to fetch the remote image or configuration file one time, be sure to turn off the remote option (blank out the field on the System Tools page) after the initial download. When a remote boot image is used, the image is transferred directly into memory and is never written to the compact flash.*

3. **Remote Configuration:** When the AP boots up, it fetches the specified configuration file from the TFTP server defined above, and applies this configuration **after** the local configuration is applied. The remote configuration must be an AP configuration file with a **.conf** extension. Make sure to place the file on the TFTP server.

A partial configuration file may be used. For instance, if you wish to use a single configuration file for all of your APs but don't want to have the

same IP address for each AP, you may remove the **ipaddr** line from the file. You can then load the file on each AP and the local IP addresses will not change.

A remote configuration is never saved to the compact flash unless you issue a Save command.

## Configuration Management

Figure 193. Configuration Management

1. If you need an updated license (for example, if you are upgrading an AP to a new major release—say, from 7.0 to 7.1, and you are not using XMS to perform network-wide updates), you may obtain one through **Auto-provisioning**. Click the **Start** button, and the AP will contact the Riverbed server with its serial number and MAC address to obtain and install its latest license. If the AP is unable to access the activation server, it will continue to attempt to contact the server at intervals specified by the **Polling Interval** (the default value is one minute). Click the **Stop** button if you wish to stop contacting the server.
2. **Update from Remote File:** This field allows you to define the path to a configuration file (one that you previously saved—see [Step 4](#) and [Step 6](#) below). Click on the **Browse** button if you need to browse for the location of the file, then click **Update** to update your configuration settings.
3. **Update from Local File:** This field updates AP settings from a local configuration file on the AP. Select one of the following files from the drop-down list:

- **factory.conf:** The factory default settings.
- **lastboot.conf:** The setting values from just before the last reboot.
- **saved.conf:** The last settings that were explicitly saved using the **Save** button  at the top of each window.
- **history/saved-yyyyymmdd-pre-update.conf:**  
**history/saved-yyyyymmdd-post-update.conf:**  
Two files are automatically saved for a software upgrade or for a license change (including the setting values from just before the upgrade/change was performed, and the initial values afterward. The filename includes the date.
- **history/saved-yyyyymmdd-auto.conf:** Each time you use the **Save** button, an “auto” file is saved with the settings current at that time.
- **history/saved-yyyyymmdd-pre-reset.conf:**  
**history/saved-yyyyymmdd-post-reset.conf:**  
Each time you use one of the **Reset to Factory Default** buttons, two files are saved: the setting values from just before the reset, and the initial values afterward. The filename includes the reset date.
- **history/saved-yyyyymmdd-hhmm.conf:** The setting values that were explicitly saved using the **Set Restore Point** button (see [Step 4](#) below).

Click **Update** to update your configuration settings by appending to the current AP configuration. Click **Restore** to replace the AP configuration with the configuration file selected.

Note that the History folder allows a maximum of 16 files. The oldest file is automatically deleted to make room for each new file.

4. **Save to Local File:** There are a few options for explicitly requesting the AP to save your current configuration to a file on the AP:
  - To view the list of configuration files currently on the AP, click the down arrow to the right of this field. If you wish to replace one of these files (i.e., save the current configuration under an existing file name), select the file, then click **Save**. Note that you cannot save to

the file names **factory.conf**, **lastboot.conf**, and **saved.conf** - these files are write-protected.

- You may enter the desired file name, then click **Save**.
- Click **Set Restore Point** to save a copy of the current configuration, basing the file name on the current date and time. For example:

**history/saved-20100318-1842.conf**

Note that the configuration is automatically saved to a file in a few situations, as described in [Step 3](#) above.



***Important!** When you have initially configured your AP, or have made significant changes to its configuration, we strongly recommend that you save the configuration to a file in order to have a safe backup of your working configuration.*

5. **Apply Quick Configuration Template:** This offers predefined configuration options such as **Classroom** and **High-Density** that capture best practices from years of field experience. If one of the options in the drop-down list is appropriate to your deployment, select it and click **Apply**. For example, the **High-Density** option uses best practices to configure the AP for high density settings such as lecture halls, convention centers, stadiums, etc.
6. **Download Current Configuration:** Click on the link titled **xs\_current.conf** to download the AP's current configuration settings to a file (that you can upload back to the AP at a later date). The system will prompt you for a destination for the file. The file will contain the AP's current configuration values.
7. **Reset to Factory Defaults:** Click on the **Reset/Preserve IP Settings** button to reset the system's current configuration settings to the factory default values, *except for the AP's management IP address which is left unchanged*. This function allows you to maintain management connectivity to the AP even after the reset. This will retain the Gigabit Ethernet port's IP address (see "[Interfaces](#)" on page 174), or if you have configured management



over a VLAN it will maintain the management VLAN's IP address (see “VLAN Management” on page 221). *All other previous configuration settings will be lost.*

Click **Reset** to reset all of the system's current configuration settings to the factory default values, including the management IP address—*all previous configuration settings will be lost.* The AP's Gigabit Ethernet ports default to using DHCP to obtain an IP address.



*If the IP settings change, the connection to the WMI may be lost.*

### Diagnostics

8. **Diagnostic Log:** Click the **Create** button to update the AP information for use by Riverbed Customer Support personnel. The name of the log file ends with `diagnostic.log`, and may have an additional prefix. (Figure 194)

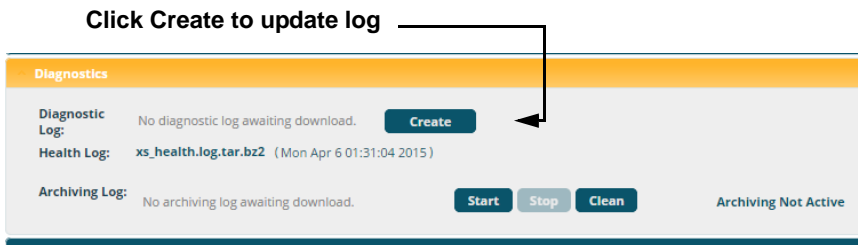

Figure 194. Saving the Diagnostic Log

This feature is only used at the request of Customer Support. It saves all of the information regarding your AP, including status, configuration, statistics, log files, and recently performed actions. Additionally, information used by XMS regarding the health and operation of processes internal to ArrayOS is produced in a log file. This XMS log is included at the end of the diagnostic log. You can also use a CLI command to display this information for customer support personnel. See “[show Commands](#)” on page 447.

The diagnostic log is always saved on your C:\ drive, so you should immediately rename the file to save it. This way, it will not be lost the next time you save a diagnostic log. Often, Customer Support will instruct you to save two diagnostic logs about ten minutes apart so that they can examine the difference in statistics between the two snapshots (for example, to see traffic and error statistics for the interval). Thus, you must rename the first diagnostic log file.



*All passwords are stored on the AP in an encrypted form and will not be exposed in the diagnostic log.*

9. **Health Log:** This file is created automatically when the AP encounters an unexpected situation, although often, the problem (if any) is minor. Typically, this file will not exist. The Diagnostic Log **Update** button has no effect on this file whatsoever. When a health log exists, the filename **xs\_health.log.bz2** is displayed in blue and provides a link to the log file. This file is normally only used at the request of Customer Support.
10. **Archiving Log:** This log saves internal status information that may be needed by Riverbed Customer Support personnel. Click the **Start** button to start accumulating this information. The size of the file is self-limiting so that you do not need to be concerned about it consuming too much storage space. Click the **Stop** button to stop accumulating data and make it available in a tar file, named `engineeringlogs_<hostname>.tar`. A link to this tar file appears. Click it to download the file. If you wish to click the **Start** button again to accumulate data for a later time interval, you should first download and rename the current file before it gets overwritten.

You may use the **Clear** button to remove the tar file and all temporary data from the AP's memory.

This feature should only be used at the request of Customer Support.

### Application Control Signature File Management

Application Control recognizes applications using a file containing the signatures of hundreds of applications. This file may be updated regularly to

keep up as Internet usage evolves over time. The latest signature file is available from the same location that you use to download the latest ArrayOS release: [ArrayOS - XR Platform Latest Release](#). Note that new ArrayOS releases will automatically contain the latest signature file available at the time of the build.

See “[Application Control Windows](#)” on page 154 for more information about using Application Control.

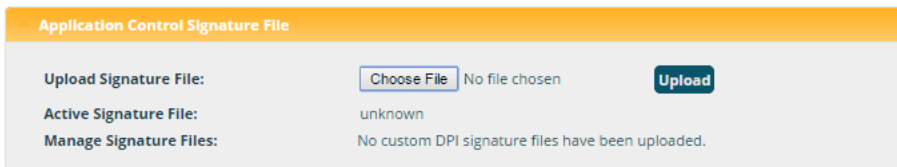

Figure 195. Managing Application Control Signature files

- 11. Upload Signature File:** First, download the latest signature file from the Riverbed Customer Support site: [ArrayOS - XR Platform Latest Release](#) to your file system. Click the **Browse** button, then browse to locate the new signature file. Click the **Upload** button when it appears. The new file will be uploaded to the AP and will be used for identifying applications. **You must turn Application Control off and back on again** on the Filter Management page to make the new signature file take effect. See “[Filter Management](#)” on page 399. No reboot is required.

**Active Signature File** shows which file is currently being used by Application Control. If you have installed any custom DPI signature files, you may use **Manage Signature Files**.

## Web Page Redirect (Captive Portal)

The AP uses a Perl script and a cascading style sheet to define the default splash/login Web page that the AP delivers for WPR. You may replace these files with files for one or more custom pages of your own. See [Step 14](#) below to view the default files. See [Step 15 page 289](#) for more information about WPR and how the splash/login page is used.

Each SSID that has WPR enabled may have its own page. Custom files for a specific SSID **must** be named based on the SSID name. For example, if the SSID is named **Public**, the default `wpr.pl` and `hs.css` files should be modified as desired and renamed to `wpr-Public.pl` and `hs-Public.css` before uploading to the AP. If you modify and upload files named `wpr.pl` and `hs.css`, they will replace the factory default files and will be used for any SSID that does not have its own custom files, per the naming convention just described. Be careful not to replace the default files unintentionally.

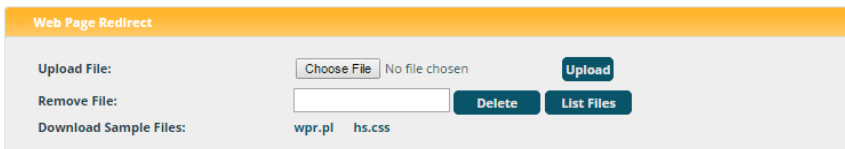

The screenshot shows a web interface titled "Web Page Redirect" with a yellow header. It contains three sections: "Upload File:" with a "Choose File" button and "No file chosen" text, and an "Upload" button; "Remove File:" with an empty text input field, a "Delete" button, and a "List Files" button; and "Download Sample Files:" with links for "wpr.pl" and "hs.css".

Figure 196. Managing WPR Splash/Login page files

- 12. Upload File:** Use this to install files for your own custom WPR splash/login page (as described above) on the AP. Note that uploaded files are not immediately used - you must reboot the AP first. At that time, the AP looks for and uses these files, if found.

Click **Choose File** to locate the splash/login page files, then click on the **Upload** button to upload the new files to the AP. You must reboot to make your changes take effect.

13. **Remove File:** Enter the name of the WPR file you want to remove, then click on the **Delete** button. You can use the **List Files** button to show you a list of files that have been saved on the AP for WPR. The list is displayed in the **Status** section at the bottom of the WMI window. You must reboot to make your changes take effect.
14. **Download Sample Files:** Click on a link to access the corresponding sample WPR files:
  - **wpr.pl**—a sample Perl script.
  - **hs.css**—a sample cascading style sheet.

### Network Tools

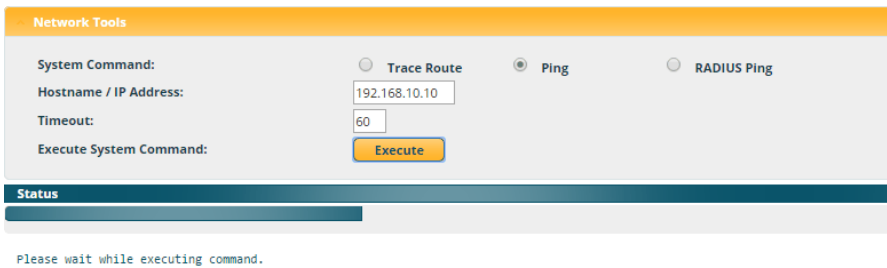

The screenshot shows a web interface titled "Network Tools". It has three radio buttons for "Trace Route", "Ping", and "RADIUS Ping", with "Ping" selected. Below these are input fields for "Hostname / IP Address" (containing "192.168.10.10") and "Timeout:" (containing "60"). An "Execute" button is positioned below the "Execute System Command:" label. A "Status" section at the bottom contains the text "Please wait while executing command."

Figure 197. System Command (Ping)

15. **System Command:** Choose **Trace Route**, **Ping**, or **RADIUS Ping**. For Trace Route and Ping, fill in **IP Address** and **Timeout**. Then click the **Execute** button to run the command.

The RADIUS Ping command is a simple utility that tests connectivity to a RADIUS server by attempting to log in with the specified Username and Password. When using a RADIUS server, this command allows you to verify that the server configuration is correct and whether a particular Username and Password are set up properly. If a client is having trouble accessing the network, you can quickly determine if there is a basic RADIUS problem by using the RADIUS Ping tool. For example, in [Figure 198 \(A\)](#), RADIUS Ping is unable to contact the server. In [Figure 198](#)

(B), RADIUS Ping verifies that the host information and secret for a RADIUS server are correct, but that the user account information is not.

**Select RADIUS** allows you to select a RADIUS server that you have already configured. When you make a choice in this field, additional fields will be displayed. Set **Select RADIUS** to [External Radius](#), [Internal Radius](#), or a server specified for a particular SSID, or select **Other Server** to specify another server by entering its **Host** name or IP address, **Port**, and shared **Secret**.

Enter the **RADIUS Credentials: Username** and **Password**. Select the **Authentication Type**, **PAP** or **CHAP**. Click the **Execute** button to run the command. The message **Testing RADIUS connection** appears. Click **OK** to proceed.

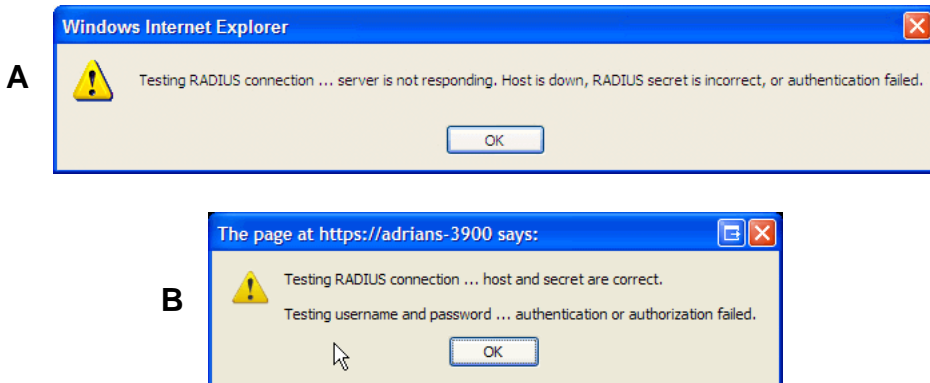

Figure 198. Radius Ping Output

16. **IP Address:** For Ping or Trace Route, enter the IP address of the target device.
17. **Timeout:** For Ping or Trace Route, enter a value (in seconds) before the action times out.
18. **Execute System Command:** Click **Execute** to start the specified command. Progress of command execution is displayed in the **Progress** frame. Results are displayed in the **Status** frame.

### Progress Bar and Status Frame

The **Progress** bar is displayed for commands such as Software Upgrade and Ping. The **Status** frame presents the output from system commands (Ping and Trace Route), as well as other information, such as the results of software upgrade.

### CLI

The WMI provides this window to allow you to use the AP's Command Line Interface (CLI). You can enter commands to configure the AP, or display information using show commands. You will not need to log in - you already logged in to the AP when you started the WMI.

```
factoryap# show ssid
SSID Summary Table
SSID Name      Authentication & Security
Encryption    Settings Filter List  VLAN Name  Number QoS  Band  Roaming Layer  Broa
-----
guest          802.1x      WPA Both Unique None
honeypot      Open       None  Global None
xyzcorp       802.1x      WPA Both Unique None
              - 0 Both 2-only 0
              - 0 Both 2-only 0
              - 2 Both 2-only 0

factoryap# show iap
IAP Summary Table
IAP      IAP      TX/RX Channel(s)  Channel  WiFi  Cell  TX  RX
Name    State  Type  Chains Primary + Bonds Setting  Mode  Antenna  Size  Power Threshold  Stations M
-----
iap1    up    .11abgnac 3x3  1      manual  bgn  int-omni max  20dBm  -90dBm  0 5
iap2    up    .11abgnac 3x3  157+161 auto   anac  int-omni max  20dBm  -90dBm  0 5
Totals:
=====
                                0
factoryap#
```

Figure 199. CLI Window

To enter a command, simply type it in. The command is echoed and output is shown in the normal way—that is, the same way it would be if you were using the CLI directly. You may use the extra scroll bar inside the right edge of the window to scroll through your output. If output runs past the right edge of the screen, there is also a horizontal scroll bar at the bottom of the page.

This window has some minor differences, compared to direct use of the CLI via the console or an SSH connection:

- The CLI starts in **config** mode. All configuration and show commands are available in this mode. You can “drill down” the mode further in the usual way. For example, you can type **interface iap** to change the mode to **config-iap**. The prompt will indicate the current command mode, for example:

```
My-AP(config-iap) #
```

- You can abbreviate a command and it will be executed if you have typed enough of the command to be unambiguous. The command will not auto-complete, however. Only the abbreviated command that you actually typed will be shown. You can type a partial command and press Tab to have the command auto-complete. If the partial command is ambiguous a list of legal endings is displayed.
- Entering **quit** will return you to the previously viewed WMI page.
- Most, but not all, CLI commands can be run in this window. Specifically the **run-test** menu of commands is **not** available in this window. To use the run-test command, please connect using SSH and use CLI directly, or use the [System Tools](#) described in this chapter, such as Trace Route, Ping, and RADIUS Ping.

Help commands (the ? character) are available, either at the prompt or after you have typed part of a command.



## API Documentation

APs provide an API interface conforming to the RESTful API model. Developers may use this read-only API to read status, statistics, and settings from the AP. The interactive API Documentation page provides documentation for the API. Access this feature by clicking the **API Documentation** link under **Tools**.

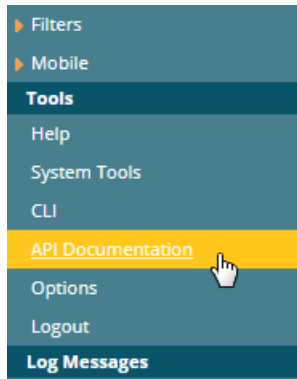
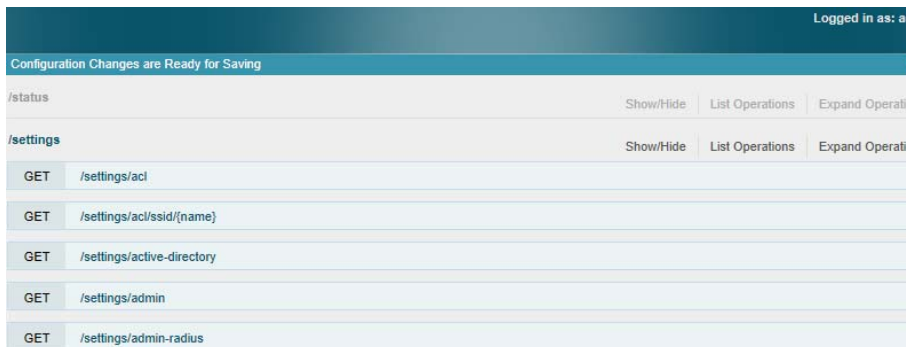

Figure 200. Accessing API Documentation

You may use the AP's API for purposes such as integrating with third party applications or creating your own applications for network monitoring and analysis. Using the RESTful API eliminates the need to use CLI scripting, or to use SNMP which can be cumbersome for polling large amounts of data. Results are returned in JavaScript Object Notation (JSON) format, a text-based open standard designed for human-readable data interchange. The API documentation is tightly integrated with the server code. The API Documentation page allows you to interact with the API in a sandbox UI that gives clear insight into how the API responds to parameters and options.

Security for the API is provided with OAuth, as described in [“OAuth 2.0 Management” on page 271](#). Once registration is completed and a permanent token for this AP has been obtained, your application may access the RESTful API using the **client\_id** and the **token** at the following URL:

```
https://[AP hostname or IP address]/api/v3/[api-name]
```



The screenshot shows a web interface for API documentation. At the top right, it says "Logged in as: a". Below that is a teal banner that reads "Configuration Changes are Ready for Saving". The main content area is a table with two main sections: "/status" and "/settings". Each section has a "Show/Hide" button, a "List Operations" button, and an "Expand Operati..." button. Under the "/settings" section, there is a list of GET requests:

Method	Endpoint
GET	/settings/ac1
GET	/settings/ac/ssid/{name}
GET	/settings/active-directory
GET	/settings/admin
GET	/settings/admin-radius

Figure 201. API Documentation

The API Documentation page lists all of the APIs that are available, lists their calling parameters, if any, and allows you to perform sample calls and view sample output.

### Status/Settings

The RESTful API on the AP is broken into these two main headings: **status** and **settings**. Each is a node that may be clicked to expand or collapse the list of corresponding API requests available on the AP. Since this is a read-only API, the list consists exclusively of GET operations.

The figure below shows part of the list displayed by clicking **/settings**. Click again to collapse (hide) the list.

**Status** requests include **GET** requests for many of the status and statistics items described in the chapter titled, "[Viewing Status on the Wireless AP](#)" on page 99. **Settings** requests include **GET** requests for many of the settings described in the chapter titled, "[Configuring the Wireless AP](#)" on page 165

## GET Requests

Each request name in the list is a link. Click it to see more information and to try the API and see its output.

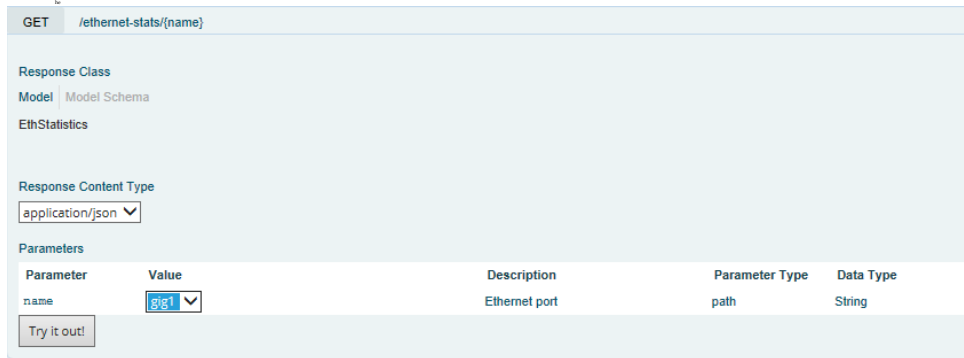

Figure 202. API — GET Request Details

The figure above shows the GET request for **ethernet-stats{name}**. Click again to collapse (hide) the API details.

High-level details are shown, including the **Response Class** name and the **Response Content Type** (limited to JSON at this time).

### Trying a GET Request

The **Try it out!** button allows you to send the GET request to the AP API and see its response. Developers can use this feature to design and implement applications that use this response.

Enter any necessary **Parameters** and click the **Try it out!** button. Most GET requests do not use any parameters. If they are required, their names will be listed and there will be a field or a drop-down list to specify each one. An example is shown in [Figure 202](#). In some cases, there may be two versions of a request, with and without parameters. For example, **GET /ethernet-stats/{name}** returns status and statistics for a particular Ethernet port, while **GET /ethernet-stats/** returns information for all Ethernet ports.

Parameters

Parameter	Value	Description	Parameter Type	Data Type
name	gig1	Ethernet port	path	String

Try it out [Hide Response](#)

Request URL

```
https://192.168.1.84/api/v3/ethernet-stats/gig1
```

Response Body

```
{
  "ethStatistics": {
    "entries": [
      {
        "dev": "gig1",
        "status": "up",
        "link": "up",
        "duplex": "full",
        "speed": 1000,
        "rxBytes": 14265626545,
        "rxPackets": 10813619,
        "rxErrTotal": 0,
        "rxDropped": 0,
        "rxErrFifo": 0,
        "rxErrFrame": 0,
        "rxCompressed": 0,
        "rxMulticast": 8129728,
        "txBytes": 151374244,
        "txPackets": 1580589,
        "txErrTotal": 0,
        "txDropped": 0,
        "txErrFifo": 0,
        "txErrCollisions": 0,

```

Response Code

```
200
```

Response Headers

```
Date: Sat, 03 May 2014 23:56:48 GMT
Server: Boa/0.94.14rc21
Accept-Ranges: bytes
Connection: close
Content-Type: application/json
```

Figure 203. API — GET Request Response

The figure above shows the response for **ethernet-stats{name}**. The response is produced in the human-readable JSON format. The status and statistics data shown are as described in “[Viewing Status on the Wireless AP](#)” on page 99. Click **Hide Response** if you wish to hide the output.

The **Response Code** and the **Response Header** are standard for HTTP(S).

## API Documentation Toolbar

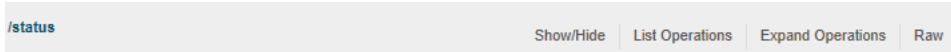

Figure 204. API Documentation Toolbar

The Status and Settings sections each have a toolbar as shown above, offering the following options.

- **Show/Hide**—expands or collapses this list of GET requests. Hiding and then showing again displays the requests as they were before, i.e., expanded GET requests will still be expanded when displayed again.
- **List Operations**—expands this list of GET requests. Each individual entry is collapsed.
- **Expand Operations**—shows all of the GET requests in this list. Each individual entry is expanded.
- **Raw**—shows the source XML code for this list of GET requests. Click the link for the API Documentation page again to return to the normal display.

## Options

This window allows you to customize the behavior of the WMI.

The image shows a screenshot of a web interface for configuring WMI display options. At the top right, it says "Logged in as: admin" with a user icon. Below that, a teal banner reads "Configuration Changes are Ready for Saving" with a save icon. The main configuration area has a label "Refresh interval in seconds:" followed by a text input field containing the number "30".

Logged in as: admin

Configuration Changes are Ready for Saving

Refresh interval in seconds:

Figure 205. WMI Display Options

### *Procedure for Configuring Options*

1. **Refresh Interval in Seconds:** Many of the windows in the Status section of the WMI have an Auto Refresh option. You may use this setting to change how often a status or statistics window is refreshed, if its auto refresh option is enabled. Enter the desired number of seconds between refreshes. The default refresh interval is 30 seconds.

## Logout

Click on the Logout button to terminate your session. When the session is terminated, you are presented with the login window.



Figure 206. Login Window





# The Command Line Interface

This section covers the commands and the command structure used by the AP's Command Line Interface (CLI), and provides a procedure for establishing an SSH connection to the AP. Topics discussed include:

- [“Establishing a Secure Shell \(SSH\) Connection” on page 437.](#)
- [“Getting Started with the CLI” on page 439.](#)
- [“Top Level Commands” on page 442.](#)
- [“Configuration Commands” on page 454.](#)
- [“Sample Configuration Tasks” on page 506.](#)



*Some commands are only available if the AP's license includes appropriate features or if the AP model supports it. If a command is unavailable, an error message will notify you. See [“About Licensing and Upgrades” on page 412.](#)*

## See Also

[Zero-Touch Provisioning and Ongoing Management](#)  
[Network Map](#)  
[System Tools](#)

## Establishing a Secure Shell (SSH) Connection

Use this procedure to initialize the system and log in to the Command Line Interface (CLI) via a Secure Shell (SSH) utility, such as PuTTY. When connecting to the unit's Command Line Interface over a network connection, you must use a Secure SHell version 2 (SSH-2) utility. Make sure that your SSH utility is set up to use SSH-2.

1. Start your SSH session and communicate with the AP via its IP address.
  - If the AP is connected to a network that uses DHCP, use the address assigned by DHCP. We recommend that you have the network

administrator assign a reserved address to the AP for ease of access in the future.

- If the network does not use DHCP, use the factory default address 10.0.2.1 to access either the Gigabit 1 or Gigabit 2 Ethernet port. You may need to change the IP address of the port on your computer that is connected to the AP—change that port’s IP address so that it is on the same 10.0.2.xx subnet as the AP port.
2. At the login prompt, enter your user name and password (the default for both is **admin**). Login names and passwords are case-sensitive. You are now logged in to the AP’s Command Line Interface.

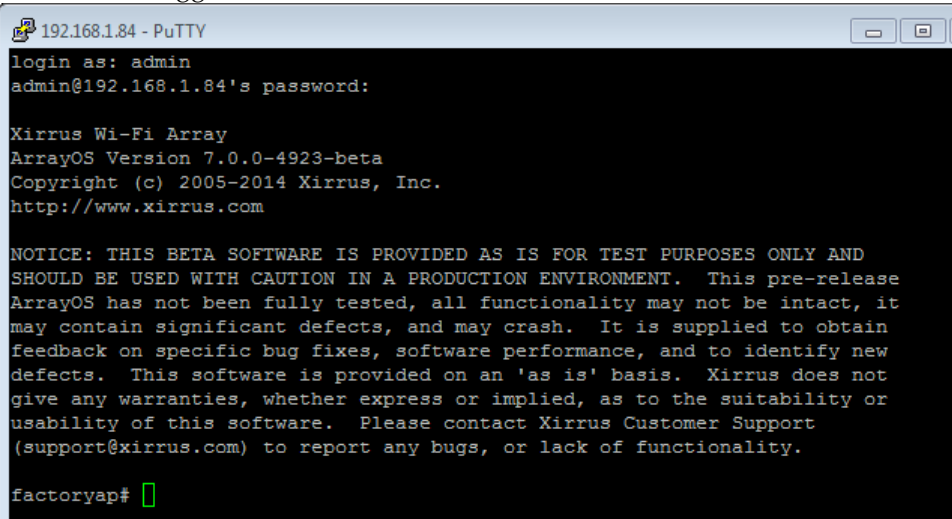

```
192.168.1.84 - PuTTY
login as: admin
admin@192.168.1.84's password:

Xirrus Wi-Fi Array
ArrayOS Version 7.0.0-4923-beta
Copyright (c) 2005-2014 Xirrus, Inc.
http://www.xirrus.com

NOTICE: THIS BETA SOFTWARE IS PROVIDED AS IS FOR TEST PURPOSES ONLY AND
SHOULD BE USED WITH CAUTION IN A PRODUCTION ENVIRONMENT. This pre-release
ArrayOS has not been fully tested, all functionality may not be intact, it
may contain significant defects, and may crash. It is supplied to obtain
feedback on specific bug fixes, software performance, and to identify new
defects. This software is provided on an 'as is' basis. Xirrus does not
give any warranties, whether express or implied, as to the suitability or
usability of this software. Please contact Xirrus Customer Support
(support@xirrus.com) to report any bugs, or lack of functionality.

factoryap# █
```

Figure 207. Logging In

## Getting Started with the CLI

The root command prompt (**Root Command Prompt**) is the first prompt you see after logging in to the CLI. If you are at a level other than the root command prompt you can return to this prompt at any time by using the **exit** command to step back through each command prompt level. The root command prompt you see in the CLI window is determined by the host name you assigned to your AP. The prompt **Riverbed\_Wi-Fi\_AP** is displayed throughout this document simply as a sample **host name** assigned to the AP. To terminate your session at any time, use the **quit** command.

## Entering Commands

When typing commands, you need only type enough characters to uniquely specify the command. For example, you can type the abbreviated term **config** to access the configure prompt, or even simply type **c**, since no other top level command starts with “c”.

## IPv4 and IPv6

Riverbed APs running Release 8.1 or higher support IPv6 addressing. For CLI commands that previously only handled IPv4, you typically used a setting such as **ip** to specify a server address. To accommodate IPv6, now you have two options (i.e., a choice of two different settings such as **ipv4** or **ipv6**) to specify the same server. For older configuration files, **ip** settings will be accepted and are handled as IPv4.

## Getting Help

The CLI offers the following two levels of assistance:

- help Command

The **help** command is only available at the root command prompt. Initiating this command generates a window that provides information about the types of help that are available with the CLI.

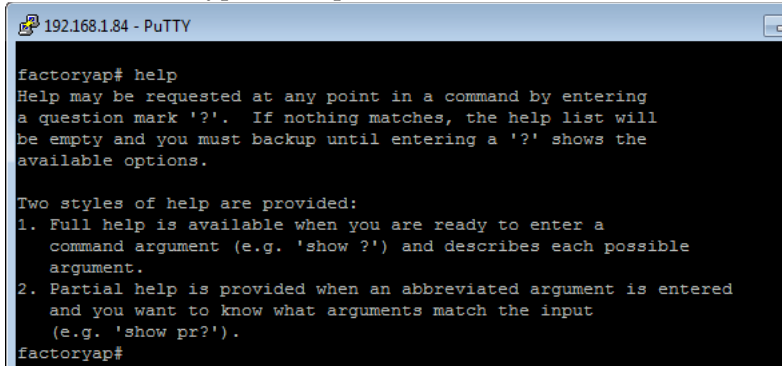

```
192.168.1.84 - PuTTY
factoryap# help
Help may be requested at any point in a command by entering
a question mark '?'. If nothing matches, the help list will
be empty and you must backup until entering a '?' shows the
available options.

Two styles of help are provided:
1. Full help is available when you are ready to enter a
   command argument (e.g. 'show ?') and describes each possible
   argument.
2. Partial help is provided when an abbreviated argument is entered
   and you want to know what arguments match the input
   (e.g. 'show pr?').
factoryap#
```

Figure 208. Help Window

- ? Command

This command is available at any prompt and provides either FULL or PARTIAL help. Using the ? (question mark) command when you are ready to enter an argument will display all the possible arguments (full help). Partial help is provided when you enter an abbreviated argument and you want to know what arguments will match your input.

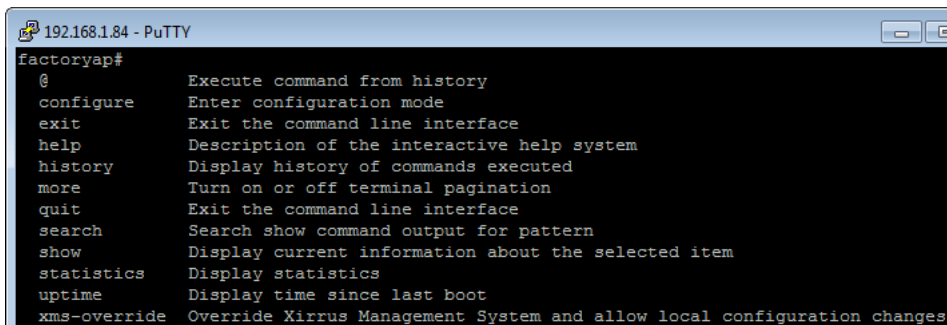

```
192.168.1.84 - PuTTY
factoryap#
@           Execute command from history
configure   Enter configuration mode
exit        Exit the command line interface
help        Description of the interactive help system
history     Display history of commands executed
more        Turn on or off terminal pagination
quit        Exit the command line interface
search      Search show command output for pattern
show        Display current information about the selected item
statistics  Display statistics
uptime      Display time since last boot
xms-override Override Xirrus Management System and allow local configuration changes
factoryap#
```

Figure 209. Full Help

Figure 210 shows an example of how the Help system can provide the argument and format when specifying the time zone under the **date-time** command.

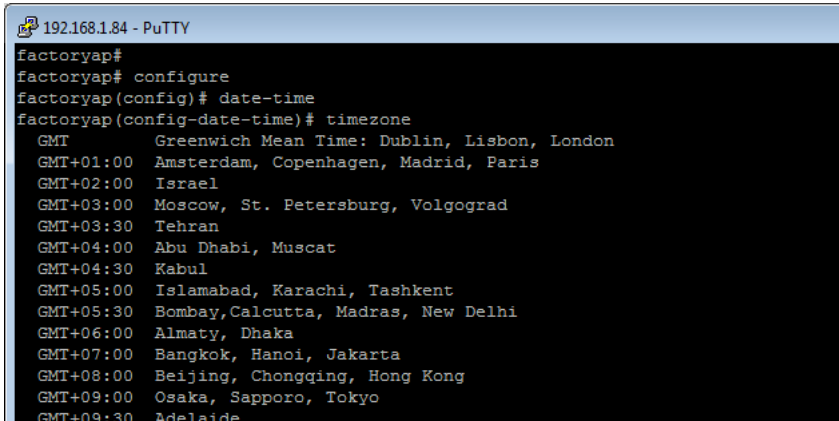

```
192.168.1.84 - PuTTY
factoryap#
factoryap# configure
factoryap(config)# date-time
factoryap(config-date-time)# timezone
GMT          Greenwich Mean Time: Dublin, Lisbon, London
GMT+01:00    Amsterdam, Copenhagen, Madrid, Paris
GMT+02:00    Israel
GMT+03:00    Moscow, St. Petersburg, Volgograd
GMT+03:30    Tehran
GMT+04:00    Abu Dhabi, Muscat
GMT+04:30    Kabul
GMT+05:00    Islamabad, Karachi, Tashkent
GMT+05:30    Bombay, Calcutta, Madras, New Delhi
GMT+06:00    Almaty, Dhaka
GMT+07:00    Bangkok, Hanoi, Jakarta
GMT+08:00    Beijing, Chongqing, Hong Kong
GMT+09:00    Osaka, Sapporo, Tokyo
GMT+09:30    Adelaide
```

Figure 210. Partial Help

## Top Level Commands

This section offers an at-a-glance view of all top level commands—organized alphabetically. Top level commands are defined here as commands that are directly accessible from the root command prompt that consists of the name of the AP followed by a “#” sign (e.g. **MyAP#**). When inputting commands, be aware that all commands are **case-sensitive**.

All other commands are considered second level configuration commands—these are the commands you use to configure specific elements of the AP’s features and functionality. For a listing of these commands with examples of command formats and structure, go to [“Configuration Commands” on page 454](#).

## Root Command Prompt

The following table shows the top level commands that are available from the root command prompt [**MyAP**].

Command	Description
@	Type <b>@n</b> to execute command <b>n</b> (as shown by the <a href="#">history</a> command).
<b>configure</b>	Enter the configuration mode. See <a href="#">“Configuration Commands” on page 454</a> .
<b>exit</b>	Exit the CLI and terminate your session—if this command is used at any level other than the root command prompt you will simply exit the current level (step back) and return to the previous level.
<b>help</b>	Show a description of the interactive help system. See also, <a href="#">“Getting Help” on page 439</a> .
<b>history</b>	List history of commands that have been executed.
<b>more</b>	Turn terminal pagination ON or OFF.
<b>quit</b>	Exit the Command Line Interface (from any level).
<b>search</b>	Search for pattern in show command output.

Command	Description
<b>show</b>	Display information about the selected item. See <a href="#">“show Commands” on page 447</a> .
<b>statistics</b>	Display statistical data about the AP. See <a href="#">“statistics Commands” on page 452</a> .
<b>uptime</b>	Display the elapsed time since the last boot.
<b>xms-override</b>	Override XMS managed mode and allow local configuration changes according to your user privileges. See <a href="#">“Managing APs Locally or Using XMS” on page 89</a> .

### configure Commands

The following table shows the second level commands that are available with the top level **configure** command [**MyAP(config)#**].

Command	Description
<b>@</b>	Type <b>@n</b> to execute command <b>n</b> (as shown by the <a href="#">history</a> command).
<b>acl</b>	Configure the Access Control List.
<b>activation</b>	Start or stop activation server polling
<b>admin</b>	Define administrator access parameters.
<b>auth</b>	Configure Oauth tokens.
<b>authentication-server</b>	Configure authentication server parameters
<b>bluetooth</b>	Configure Bluetooth/iBeacon settings.
<b>boot-env</b>	Display or modify boot loader environment variables.
<b>cdp</b>	Configure Cisco Discovery Protocol settings.

Command	Description
<b>clear</b>	Remove/clear the requested elements.
<b>cluster</b>	Make configuration changes to multiple APs.
<b>contact-info</b>	Contact information for assistance on this AP.
<b>date-time</b>	Configure date and time settings.
<b>device-id</b>	Add new device-ids for use in groups.
<b>dhcp-server</b>	Configure the DHCP Server.
<b>dns</b>	Configure the DNS settings.
<b>end</b>	Exit the configuration mode.
<b>exit</b>	Go UP one mode level.
<b>file</b>	Manage the file system.
<b>filter</b>	Define protocol filter parameters.
<b>group</b>	Define user groups with parameter settings
<b>help</b>	Description of the interactive Help system.
<b>history</b>	List history of commands that have been executed.
<b>hostname</b>	Host name for this AP.
<b>interface</b>	Select the interface to configure.
<b>lldp</b>	Configure LLDP settings
<b>load</b>	Load running configuration from flash
<b>location</b>	Location name for this AP.
<b>location-reporting</b>	Configure location server settings.
<b>management</b>	Configure AP management parameters



Command	Description
<b>mdm</b>	Configure mobile device management server settings.
<b>more</b>	Turn ON or OFF terminal pagination.
<b>netflow</b>	Configure NetFlow data collector.
<b>no</b>	Disable (if enabled) or set to default value.
<b>proxy-fwd</b>	Configure Proxy Forwarding settings.
<b>quick-config</b>	Apply configuration template for typical deployment scenario.
<b>quit</b>	Exit the Command Line Interface.
<b>reboot</b>	Reboot the AP.
<b>reset</b>	Reset all settings to their factory default values and reboot.
<b>restore</b>	Reset all settings to their factory default values and reboot.
<b>revert</b>	Revert to saved configuration after specified delay in seconds if configuration not saved.
<b>roaming-assist</b>	Set parameters for roaming assistance.
<b>run-tests</b>	Run selective tests.
<b>save</b>	Save the running configuration to FLASH.
<b>search</b>	Search for pattern in show command output.
<b>security</b>	Set the security parameters for the AP.
<b>show</b>	Display current information about the selected item.
<b>snmp</b>	Enable, disable or configure SNMP.
<b>ssid</b>	Configure the SSID parameters.

Command	Description
<b>station- assurance</b>	Location name for this AP.
<b>statistics</b>	Display statistics.
<b>syslog</b>	Enable, disable or configure the Syslog Server.
<b>tunnel</b>	Configure tunnels.
<b>uptime</b>	Display time since the last boot.
<b>vlan</b>	Configure VLAN parameters.
<b>wifi-tag</b>	Disable Wi-Fi tag RFID capabilities.
<b>xms-override</b>	Override XMS managed mode and allow local configuration changes according to your user privileges. See <a href="#">“Managing APs Locally or Using XMS”</a> on page 89.

**show Commands**

The following table shows the second level commands that are available with the top level **show** command [**MyAP# show**].

Command	Description
<b>acl</b>	Display the Access Control List.
<b>active-directory</b>	Show Active Directory information.
<b>admin</b>	Display the administrator list or login information.
<b>applications</b>	Application statistics.
<b>arp</b>	ARP table information.
<b>associated-stations</b>	Display stations that have associated to the AP.
<b>auth</b>	Show Open Authentication tokens.
<b>authentication-server</b>	Authentication server settings summary.
<b>bluetooth</b>	Display Bluetooth/iBeacon settings.
<b>bond</b>	Bond information
<b>boot-env</b>	Display Boot loader environment variables.
<b>capabilities</b>	Display detailed station capabilities.
<b>cdp</b>	Display Cisco Discovery Protocol settings.
<b>channel-list</b>	Display list of AP's 802.11an and bgn channels.
<b>cluster</b>	Display Cluster summary.
<b>clear-text</b>	Display and enter passwords and secrets in the clear.
<b>conntrack</b>	Display the Connection Tracking table.
<b>console</b>	Display terminal settings.

Command	Description
<b>contact-info</b>	Display contact information.
<b>country-list</b>	Display countries that the AP can be set to support.
<b>date-time</b>	Display date and time settings summary.
<b>dhcp-leases</b>	Display IP addresses (leases) assigned to stations by the DHCP server.
<b>dhcp-pool</b>	Display internal DHCP server settings summary information.
<b>diff</b>	Display the difference between configurations.
<b>dns</b>	Display DNS summary information.
<b>env-ctrl</b>	Display the environmental controller status for the outdoor enclosure.
<b>error-numbers</b>	Display the detailed error number in error messages.
<b>ethernet</b>	Display Ethernet interface summary information.
<b>external-radius</b>	Display summary information for the external RADIUS server settings.
<b>factory-config</b>	Display the AP factory configuration information.
<b>filter</b>	Display filter information.
<b>filter-list</b>	Filter list information.
<b>group</b>	User Group summary.
<b>iap</b>	Display IAP configuration information.
<b>ids-event-log</b>	IDS event log.
<b>ids-stats</b>	IDS statistics
<b>internal-radius</b>	Display the users defined for the embedded RADIUS server.

Command	Description
<b>intrude-detect</b>	Intrusion detection information.
<b>lastboot-config</b>	Display AP configuration at the time of the last boot-up.
<b>lldp</b>	Link Layer Discovery Protocol information.
<b>location-reporting</b>	Location server reporting information.
<b>mac-table</b>	MAC address bridging table
<b>management</b>	Display settings for managing the AP, plus Standby, FIPS, and other information.
<b>mdm</b>	MDM (Mobile Device Management) information
<b>netflow</b>	NetFlow information
<b>network-assurance</b>	Network Assurance status
<b>network-map</b>	Display network map information.
<b>proxy-fwd</b>	Display Proxy Forwarding summary.
<b>radio-assurance</b>	Radio Assurance status.
<b>realtime-monitor</b>	Display realtime statistics for all IAPs.
<b>roaming-assist</b>	Roaming assist settings
<b>roaming-stations</b>	Roaming station information
<b>rogue-ap</b>	Display rogue AP information.
<b>route</b>	Display the routing table.
<b>rss-map</b>	Display RSSI map by IAP for station.
<b>running-config</b>	Display configuration information for the AP currently running.
<b>saved-config</b>	Display the last saved AP configuration.

Command	Description
<b>security</b>	Display security settings summary information.
<b>self-test</b>	Display self test results.
<b>snmp</b>	Display SNMP summary information.
<b>spanning-tree</b>	Display spanning tree information.
<b>spectrum-analyzer</b>	Display spectrum analyzer measurements.
<b>ssid</b>	Display SSID summary information.
<b>station-assurance</b>	Station assurance information.
<b>stations</b>	Display station information.
<b>statistics</b>	Display statistics.
<b>syslog</b>	Display the system log.
<b>syslog-settings</b>	Display the system log (Syslog) settings.
<b>system-info</b>	System information
<b>temperature</b>	Display the current board temperatures.
<b>tunnel</b>	Tunnel information
<b>unassociated-stations</b>	Display unassociated station information.
<b>undefined-vlan</b>	Undefined VLANs detected
<b>uptime</b>	Display time since last boot.
<b>vlan</b>	Display VLAN information.
<b>wds</b>	Display WDS information.
<b>wifi-tag</b>	Display WiFi tag summary.
<b>wpr-whitelist</b>	Show WPR whitelist

Command	Description
<b>xms-log</b>	Health log for ArrayOS internal processes, used by XMS.
<b>xrp-tunnels</b>	XRP tunnel information.
<b>&lt;cr&gt;</b>	Display configuration or status information.
IAP-NAME <b>iap1, iap2</b>	IAP interface information

## statistics Commands

The following table shows the second level commands that are available with the top level **statistics** command [**MyAP# statistics**].

Command	Description
<b>ethernet</b>	Display statistical data for all Ethernet interfaces.
<b>filter</b>	Display statistics for defined filters (if any). FORMAT: <b>statistics filter [detail]</b>
<b>filter-list</b>	Display statistics for defined filter list (if any). FORMAT: <b>statistics filter &lt;filter-list&gt;</b>
<b>iap</b>	Display statistical data for the defined IAP. FORMAT: <b>statistics iap iap2</b>
<b>station</b>	Display statistical data about associated stations. FORMAT: <b>statistics station billw</b>
<b>vlan</b>	Display statistical data for the defined VLAN. You must use the VLAN number (not its name) when defining a VLAN. FORMAT: <b>statistics vlan 1</b>
<b>wds</b>	Display statistical data for the defined active WDS (Wireless Distribution System) links. FORMAT: <b>statistics wds 1</b>
<b>&lt;cr&gt;</b>	Display configuration or status information.



Command	Description
Ethernet Name <b>eth0, gig1, gig2</b>	Display statistical data for the defined Ethernet interface (either eth0, gig1 or gig2). FORMAT: <b>statistics gig1</b>
IAP-NAME <b>iap1, iap2</b>	IAP interface information

## Configuration Commands

All configuration commands are accessed by using the **configure** command at the root command prompt (**MyAP#**). This section provides a brief description of each command and presents sample formats where deemed necessary. The commands are organized alphabetically. When inputting commands, be aware that all commands are **case-sensitive**.

To see examples of some of the key configuration tasks and their associated commands, go to [“Sample Configuration Tasks” on page 506](#).

### acl

The **acl** command [**MyAP(config)# acl**] is used to configure the Access Control List.

Command	Description
<b>add</b>	Add a MAC address to the list. FORMAT: <b>acl add AA:BB:CC:DD:EE:FF</b>
<b>del</b>	Delete a MAC address from the list. FORMAT: <b>acl del AA:BB:CC:DD:EE:FF</b>
<b>disable</b>	Disable the Access Control List FORMAT: <b>acl disable</b>
<b>enable</b>	Enable the Access Control List FORMAT: <b>acl enable</b>
<b>reset</b>	Delete all MAC addresses from the list. FORMAT: <b>acl reset</b>

**admin**

The **admin** command [MyAP(config-admin)#] is used to configure the Administrator List.

Command	Description
<b>add</b>	Add a user to the Administrator List. FORMAT: <b>admin add [userID]</b>
<b>del</b>	Delete a user to the Administrator List. FORMAT: <b>admin del [userID]</b>
<b>edit</b>	Modify user in the Administrator List. FORMAT: <b>admin edit [userID]</b>
<b>privilege-name</b>	Define administrator privilege level names
<b>privilege-section</b>	Define administrator privilege level required by config section.
<b>radius</b>	Define a RADIUS server to be used for authenticating administrators. FORMAT: <b>admin radius [disable   enable   off   on   timeout &lt;seconds&gt;   auth-type [PAP   CHAP]]</b> <b>admin radius [primary   secondary]</b> <b>port &lt;portid&gt; server [&lt;ip-addr&gt;   &lt;host&gt;]</b> <b>secret &lt;shared-secret&gt;</b>
<b>reset</b>	Delete all users and restore the default user. FORMAT: <b>admin reset</b>

**auth**

The **auth** command [MyAP(config)# **auth**] is used to configure Oauth tokens.

Command	Description
<b>del</b>	Delete an Oauth token. FORMAT: <b>auth del &lt;Oauth token&gt;</b>
<b>reset</b>	Delete all Oauth tokens. FORMAT: <b>auth reset</b>

See also, “OAuth 2.0 Management” on page 271.

## bluetooth

The **bluetooth** command [MyAP(config-bluetooth)#] is used to configure iBeacon settings. iBeacons are typically used by smartphone apps that listen for the beacons and make interactive decisions based on location. For example, based on a visitor's location, a grocery store app can offer product promotions or a

Command	Description
<b>ibeacon disable / off</b>	Disable ibeacons. FORMAT: <b>bluetooth ibeacon disable</b>
<b>ibeacon enable / on</b>	Enable ibeacons. FORMAT: <b>bluetooth ibeacon enable</b>
<b>ibeacon major</b>	The beacon's major field identifies a smaller group of beacons under the UUID—for example, a particular 7-11 store. This is a 2 byte string. FORMAT: <b>bluetooth ibeacon major &lt;2 byte string&gt;</b>
<b>ibeacon minor</b>	The beacon's minor field identifies an individual beacon under the UUID and major fields—for example, the front of the store. This is a 2 byte string. FORMAT: <b>bluetooth ibeacon minor &lt;2 byte string&gt;</b>
<b>ibeacon uuid</b>	UUID identifies the general beacon type to an app—for example, Pepsi in 7-11 stores. This is a string of up to 16 bytes. You can only define one UUID. FORMAT: <b>bluetooth ibeacon uuid &lt;string&gt;</b>

museum can offer an interactive guide.

**cdp**

The **cdp** command [MyAP(config)# **cdp**] is used to configure the Cisco Discovery Protocol.

Command	Description
<b>disable</b>	Disable the Cisco Discovery Protocol FORMAT: <b>cdp disable</b>
<b>enable</b>	Enable the Cisco Discovery Protocol FORMAT: <b>cdp enable</b>
<b>hold-time</b>	Select CDP message hold time before messages received from neighbors expire. FORMAT: <b>cdp hold-time [# seconds]</b>
<b>interval</b>	The AP sends out CDP announcements at this interval. FORMAT: <b>cdp interval [# seconds]</b>
<b>off</b>	Disable the Cisco Discovery Protocol FORMAT: <b>cdp off</b>
<b>on</b>	Enable the Cisco Discovery Protocol FORMAT: <b>cdp on</b>

**clear**

The **clear** command [**MyAP(config)# clear**] is used to clear requested elements.

Command	Description
<b>arp</b>	Clear the arp table entry for a requested IP address, or clear all entries if no IP address is entered. FORMAT: <b>clear arp [ipaddress]</b>
<b>authentication</b>	Deauthenticate a station (specified by MAC address, hostname, or IP address) and/or clear the station authentication cache if the station is connected to an SSID that uses U-PSK (see <a href="#">Step 13 on page 286</a> ). If you specify the permanent option, then the station is deauthenticated and put on the access control list. FORMAT: <b>clear authentication [permanent] [authenticated station]</b>
<b>history</b>	Clear the history of CLI commands executed. FORMAT: <b>clear history</b>
<b>screen</b>	Clear the screen where you're viewing CLI output. FORMAT: <b>clear screen</b>
<b>station- assurance</b>	Clear all station assurance data, but continue to collect new data. FORMAT: <b>clear station-assurance</b>

Command	Description
<b>statistics</b>	Clear the statistics for thee change, but it won't show up requested element. FORMAT: <b>clear statistics [ethname   all-eth   applications   filters   iap   station   vlan   wds]</b>
<b>syslog</b>	Clear all Syslog messages, but continue to log new messages. FORMAT: <b>clear syslog</b>
<b>undefined-vlan</b>	Clear undefined VLAN information. FORMAT: <b>clear undefined-vlan</b>



**cluster**

The **cluster** command [MYAP(config)# **cluster**] is used to create and operate clusters. Clusters allow you to configure multiple APs at the same time. Using CLI (or WMI), you may define a set of APs that are members of the cluster. Then you may switch the AP to Cluster operating mode for a selected cluster, which sends all successive configuration commands issued via CLI or WMI to all of the member APs. When you exit cluster mode, configuration commands revert to applying only to the AP to which you are connected.

Command	Description
<b>add</b>	Create a new AP cluster. Enters edit mode for that cluster to allow you to specify the APs that belong to the cluster. Up to 16 clusters may be created, with up to 50 APs in each. Note that the AP on which you are currently running CLI is not automatically cluster member. If you would like it to be a member, you must add it explicitly.  FORMAT: <b>cluster add [cluster-name]</b>
<b>del</b>	Delete an AP cluster. Type <b>del?</b> to list the existing clusters.  FORMAT: <b>cluster del [cluster-name]</b>
<b>edit</b>	Enter edit mode for selected cluster to add or delete APs that belong to the cluster.  FORMAT: <b>cluster edit [cluster-name]</b>

Command	Description
<b>operate</b>	Enter Cluster operation mode. All configuration commands are applied to all of the selected cluster's member APs until you give the <b>end</b> command. They are <b>not</b> performed on the AP where you are entering CLI, unless it is a member of the cluster. FORMAT: <b>cluster operate [cluster-name]</b>
<b>reset</b>	Delete all clusters. FORMAT: <b>cluster reset</b>



*An XR-500 or XR-1000 Series AP cannot act as the Cluster controller. It will operate correctly as a member of a cluster.*

### contact-info

The **contact-info** command [MyAP(config)# **contact-info**] is used for managing administrator contact information.

Command	Description
<b>email</b>	Add an email address for the contact (must be in quotation marks). FORMAT: <b>contact-info email ["contact@mail.com"]</b>
<b>name</b>	Add a contact name (must be in quotation marks). FORMAT: <b>contact-info name ["Contact Name"]</b>
<b>phone</b>	Add a telephone number for the contact (must be in quotation marks). FORMAT: <b>contact-info phone ["8185550101"]</b>

**date-time**

The **date-time** command [**MyAP(config-date-time)#**] is used to configure the date and time parameters. Your AP supports the Network Time Protocol (NTP) in order to ensure that the AP's internal time is accurate. NTP is set to UTC time by default; however, you can set the time zone so that your AP will display local time. This is done by defining an offset from the UTC value. For example, Pacific Standard Time is 8 hours behind UTC time, so the offset from UTC time would be -8.

Command	Description
<b>dst_adjust</b>	Enable adjustment for daylight savings. FORMAT: <b>date-time dst_adjust</b>
<b>no</b>	Disable daylight savings adjustment. FORMAT: <b>date-time no dst_adjust</b>
<b>ntp</b>	Enable the NTP server. FORMAT: <b>date-time ntp on</b> (or <b>off</b> to disable)
<b>offset</b>	Set an offset from Greenwich Mean Time. FORMAT: <b>date-time no dst_adjust</b>
<b>set</b>	Set the date and time for the AP. FORMAT: <b>date-time set [10:24 10/23/2007]</b>
<b>timezone</b>	Configure the time zone. FORMAT: <b>date-time timezone [-8]</b>

### device-id

This command **[MyAP(config-device-id)#]** allows the AP to recognize additional device IDs. For example, you might identify monitoring devices used in a hospital. Then those device IDs can be used to set up User **Groups** that can assign the devices to appropriate VLANs.

A device is recognized by its OUI (Organizationally Unique Identifier)—the first three octets of the device MAC address (specified as **xx:xx:xx**) identify the manufacturer. Choose the new device’s **class** from the available choices, such as **appliance**. Then use the **type** parameter to enter a name for your new device type. For example:

```
device-id add 08:08:08 class appliance type HeartMonitor
```

When a station matching the OUI authenticates with the AP, the AP assigns the station to the appropriate User Group.

Command	Description
<b>add</b>	Add a new device type. FORMAT: <b>device-id add [xx:xx:xx] class [class] type [string]</b>
<b>del</b>	Delete a device type. FORMAT: <b>device-id del [device-id]</b>
<b>edit</b>	Edit a device type FORMAT: <b>device-id edit [device-id]</b>
<b>reset</b>	Delete all device types. FORMAT: <b>device-id reset</b>

## dhcp-server

The **dhcp-server** command [MyAP(config-dhcp-server)#] is used to add, delete and modify DHCP pools.

Command	Description
<b>add</b>	Add a DHCP pool. FORMAT: <b>dhcp-server add [dhcp pool]</b>
<b>del</b>	Delete a DHCP pool. FORMAT: <b>dhcp-server del [dhcp pool]</b>
<b>edit</b>	Edit a DHCP pool FORMAT: <b>dhcp-server edit [dhcp pool]</b>
<b>reset</b>	Delete all DHCP pools. FORMAT: <b>dhcp-server reset</b>

### dns

The **dns** command [MyAP(config-dns)#] is used to configure your DNS parameters.

Command	Description
<b>domain</b>	Enter your domain name. FORMAT: <b>dns domain [www.mydomain.com]</b>
<b>server1</b>	Enter the IP address of the primary DNS server. FORMAT: <b>dns server1 [1.2.3.4]</b>
<b>server2</b>	Enter the IP address of the secondary DNS server. FORMAT: <b>dns server1 [2.3.4.5]</b>
<b>server3</b>	Enter the IP address of the tertiary DNS server. FORMAT: <b>dns server1 [3.4.5.6]</b>
<b>use-dhcp</b>	Enable or disable updates to DNS settings via DHCP. FORMAT: <b>dns use-dhcp [off   on]</b>

**file**

The **file** command [MyAP(config-file)#] is used to manage files.

Command	Description
<b>active-image</b>	Validate and commit a new AP software image.
<b>backup-image</b>	Validate and commit a new backup software image.
<b>cat</b>	List file contents.
<b>check-image</b>	Validate a new AP software image.
<b>chkdsk</b>	Check flash file system.
<b>copy</b> <b>cp</b>	Copy a file to another file. FORMAT: <b>file copy [sourcefile destinationfile]</b>
<b>create-text</b>	Create a text file on the flash file system, <EOF> to finish.
<b>dir</b>	List the contents of a directory. FORMAT: <b>file dir [directory]</b>
<b>erase</b>	Delete a file from the FLASH file system. FORMAT: <b>file erase [filename]</b>
<b>format</b>	Format flash file system.
<b>ftp</b>	Open an FTP connection with a remote server. Files will be transferred in binary mode. FORMAT: <b>file ftp host {&lt;hostname&gt;   &lt;ip&gt;} [port &lt;port_#&gt;] [user {anonymous   &lt;username&gt; password &lt;passwd&gt; } ] { put &lt;source_file&gt; [&lt;dest_file&gt;]   get &lt;source_file&gt; [&lt;dest_file&gt;] }</b> <b>Note:</b> Any time you transfer any kind of software image file for the AP, it <b>must</b> be transferred in binary mode, or the file may be corrupted.



Command	Description
<b>http-get</b>	<p>Perform an HTTP file download. This is the preferred method of downloading files for XMS Cloud.</p> <p>FORMAT:</p> <p><b>http-get [no-cert-check] &lt;url&gt; [&lt;local_file&gt;]</b></p> <p><b>no-cert-check</b> causes the AP to download the file even if the SSL certificate is invalid, expired, or not signed by a recognized CA</p> <p><b>&lt;url&gt;</b> is a standard HTTP URL, e.g. <code>https://file.example.com:8080/mydir/myfile.ext</code>.</p> <ul style="list-style-type: none"><li>• <b>http://</b> or <b>https://</b> may be omitted, in which case HTTP is assumed</li></ul> <p><b>&lt;local_file&gt;</b> is an optional parameter that describes the path and name where the file should be saved</p> <ul style="list-style-type: none"><li>• if no <code>local_file</code> is specified, the file will be saved in the root of the flash storage</li><li>• the <code>local_file</code> does support specifying a directory, which will be created if it doesn't already exist</li></ul>
<b>list</b>	<p>List the contents of a file.</p> <p>FORMAT:</p> <p><b>file list [filename]</b></p>
<b>mkdir</b>	<p>Create a directory on the flash file system.</p>
<b>mv</b>	<p>Rename a file on the flash file system.</p>

Command	Description
<b>remote-config</b>	<p>When the AP boots up, it fetches the specified configuration file from the TFTP server defined in the <b>file remote-server</b> command, and uses this configuration. This must be an AP configuration file with a <b>.conf</b> extension.</p> <p>A partial configuration file may be used. For instance, if you wish to use a single configuration file for all of your APs but don't want to have the same IP address for each AP, you may remove the <b>ipaddr</b> line from the file. You can then load the file on each AP and the local IP addresses will not change.</p> <p>FORMAT:  <b>file remote-config &lt;config-file.conf&gt;</b></p> <p><b>Note:</b> If you enter <b>file remote-config ?</b>, the help response suggests possibilities by listing all of the configuration files that are currently in the AP's flash.</p>
<b>remote-image</b>	<p>When the AP boots up, it fetches the named image file from the TFTP server defined in the <b>file remote-server</b> command, and upgrades to this file before booting. This must be an AP image file with a <b>.bin</b> extension.</p> <p>FORMAT:  <b>file remote-image &lt;image-file.bin&gt;</b></p> <p><b>Note:</b> This will happen every time that the AP reboots. If you only want to fetch the remote-image one time be sure to turn off the remote image option after the initial download.</p>
<b>remote-server</b>	<p>Sets up a TFTP server to be used for automated remote update of software image and configuration files when rebooting.</p> <p>FORMAT:  <b>file remote-server A.B.C.D</b></p>
<b>rename</b>	Rename a file.
<b>rm</b>	Delete a file from the flash file system.

Command	Description
<b>rmdir</b>	Delete a directory on the flash file system.
<b>scp</b>	Copy a file to or from a remote system. You may specify the port to use.
<b>tftp</b>	<p>Open a TFTP connection with a remote server. FORMAT: <b>file tftp host</b> {&lt;hostname&gt;   &lt;ip&gt;} [port &lt;port_#&gt;] [user {anonymous   &lt;username&gt; password &lt;passwd&gt; } ] { put &lt;source_file&gt; [&lt;dest_file&gt;]   get &lt;source_file&gt; [&lt;dest_file&gt;] }</p> <p><b>Note:</b> Any time you transfer any kind of software image file for the AP, it <b>must</b> be transferred in binary mode, or the file may be corrupted.</p>

**filter**

The **filter** command [MyAP(config-filter)#] is used to manage protocol filters and filter lists.

Command	Description
<b>add</b>	Add a filter. Details about the air cleaner feature are after the end of this table. FORMAT: <b>filter add [air-cleaner   name]</b>
<b>add-list</b>	Add a filter list. FORMAT: <b>filter add-list [name]</b>
<b>del</b>	Delete a filter. FORMAT: <b>filter del [name]</b>
<b>del-list</b>	Delete a filter list. FORMAT: <b>filter del-list [name]</b>
<b>edit</b>	Edit a filter. FORMAT: <b>filter edit [name type]</b>
<b>edit-list</b>	Edit a filter list FORMAT: <b>filter edit-list [name type]</b>
<b>enable</b>	Enable a filter list. FORMAT: <b>filter enable</b>
<b>move</b>	Change a filter priority. FORMAT: <b>filter move [name priority]</b>

Command	Description
<b>off</b>	Disable a filter list. FORMAT: <b>filter off</b>
<b>on</b>	Enable a filter list. FORMAT: <b>filter on</b>
<b>reset</b>	Delete all protocol filters and filter lists. FORMAT: <b>filter reset</b>
<b>stateful</b>	Enable or disable stateful filtering (firewall). FORMAT: <b>Stateful [enable   disable   on   off]</b>
<b>track-apps</b>	Enable or disable application tracking. FORMAT: <b>filter track-apps [enable   disable   on   off]</b>

### Air Cleaner

The air cleaner feature offers a number of predetermined filter rules that eliminate a great deal of unnecessary wireless traffic, resulting in improved performance. You may select **all** of the air cleaner rules for the greatest effect, or only specific rules, such as **broadcast** or **multicast**, to eliminate only a particular source of traffic. The following options are offered:

```
MyAP(config)# filter add air-cleaner
all          All air cleaner filters
arp         Eliminate station to station ARPs over the air
broadcast   Eliminate broadcast traffic from the air
dhcp       Eliminate stations serving DHCP addresses from the air
multicast   Eliminate chatty multicast traffic from the air
netbios     Eliminate NetBIOS traffic from the air
```

If you select all, the rules shown in [Figure 211](#) are added to the predefined filter list named **Global**. These rules assume that you have station-to-station blocking enabled, that a DHCP server is on the AP's wired connection, and that you want to block most all multicast and all broadcast traffic not vital to normal operation. If you find that there is a particular type of multicast or broadcast traffic that you want to allow, just add a specific allow filter for it before the deny filter in this list that would normally block it. Add or delete any of the Multicast rules as necessary for a specific site. Remember that the order of the rules is important.

```
MyA(config)# show filter
```

Global Filter List

Name	Type	Layer	Protocol	Port	Source	Destination	Set Qos	Set VLAN	State
Air-cleaner-Arp.1	deny	2	arp	any	iface iap	iface iap			on
Air-cleaner-Dhcp.1	deny	2	udp	bootps	iface gig	ff:ff:ff:ff:ff:ff/48			on
Air-cleaner-Dhcp.2	deny	2	udp	bootpc-dhcp	iface iap	ff:ff:ff:ff:ff:ff/48			on
Air-cleaner-Nbios.1	deny	2	udp	netbios-ns	any	any			on
Air-cleaner-Nbios.2	deny	2	udp	netbios-dgm	any	any			on
Air-cleaner-Nbios.3	deny	2	udp	netbios-ssn	any	any			on
Air-cleaner-Mcast.1	deny	2	any	any	any	01:00:00:00:00:00/8			off
Air-cleaner-Mcast.2	deny	2	any	any	any	33:00:00:00:00:00/8			off
Air-cleaner-Mcast.3	deny	2	any	any	any	09:00:00:00:00:00/8			off
Air-cleaner-Bcast.1	allow	2	arp	any	any	ff:ff:ff:ff:ff:ff/48			on
Air-cleaner-Bcast.2	allow	2	udp	bootps	any	ff:ff:ff:ff:ff:ff/48			on
Air-cleaner-Bcast.3	allow	2	udp	bootpc-dhcp	any	ff:ff:ff:ff:ff:ff/48			on
Air-cleaner-Bcast.4	allow	2	udp	22610	any	ff:ff:ff:ff:ff:ff/48			on
Air-cleaner-Bcast.5	deny	2	any	any	any	ff:ff:ff:ff:ff:ff/48			on

Stateful filtering: enabled

Figure 211. Air Cleaner Filter Rules

Explanations of some sample rules are below.

- **Air-cleaner-Arp.1** blocks ARPs from one client from being transmitted to clients via all of the radios. The station to station block setting doesn't block this traffic, so this filter eliminates this unnecessary traffic.
- **Air-cleaner-Dhcp.1** drops all DHCP client traffic coming in from the Gigabit interface. This traffic doesn't need to be transmitted by the radios since there shouldn't be any DHCP server associated to the radios and offering DHCP addresses. For large subnets the DHCP discover/request broadcast traffic can be significant.
- **Air-cleaner-Dhcp.2** drops all DHCP server traffic coming in from the radio interfaces. There should not be any DHCP server associated to the

radios. These rogue DHCP servers are blocked from doing any damage with this filter. There have been quite a few cases in public venues like schools and conventions where such traffic is seen.

- **Air-cleaner-Mcast.1** drops all multicast traffic with a destination MAC address starting with 01. This filters out a lot of IP multicast traffic that starts with 224.
- **Air-cleaner-Mcast.2** drops all multicast traffic with a destination MAC address starting with 33. A lot of IPv6 traffic and other multicast traffic is blocked by this filter.
- **Air-cleaner-Mcast.3** drops all multicast traffic with a destination MAC address starting with 09. A lot of Appletalk traffic and other multicast traffic is blocked by this filter. Note that for OSX 10.6.\* Snow Leopard no longer supports Appletalk.
- **Air-cleaner-Bcast.1** allows all ARP traffic (other than the traffic that was denied by **Air-cleaner-Arp.1**). This is needed because **Air-cleaner-Bcast.5** would drop this valid traffic.
- **Air-cleaner-Bcast.4** allows all XRP traffic from APs to be received from the wire. This is needed because **Air-cleaner-Bcast.5** would drop this valid traffic.
- **Air-cleaner-Bcast.5** drops all other broadcast traffic that hasn't previously been explicitly allowed. This filter will catch all UDP broadcast traffic as well as all other known and unknown protocol broadcast traffic.

## group

The **group** command [MyAP(config)# **group**] is used to create and configure user groups. User groups allow administrators to assign specific network parameters to users through RADIUS privileges rather than having to map users to a specific SSID. Groups provide flexible control over user privileges without the need to create large numbers of SSIDs. For more information, see “Groups” on page 310.

Command	Description
<b>add</b>	Create a new user group. FORMAT: <b>group add [group-name]</b>
<b>del</b>	Delete a user group. FORMAT: <b>group del [group-name]</b>
<b>edit</b>	Set parameters values for a group. FORMAT: <b>group edit [group-name]</b>
<b>reset</b>	Reset the group. FORMAT: <b>group reset</b>

## hostname

The **hostname** command [MyAP(config)# **hostname**] is used to change the hostname used by the AP.

Command	Description
<b>hostname</b>	Change the hostname of the AP. FORMAT: <b>hostname [name]</b>



## interface

The **interface** command [**MyAP(config)# interface**] is used to select the interface that you want to configure. To see a listing of the commands that are available for each interface, use the **?** command at the selected interface prompt. For example, using the **?** command at the **MyAP(config-gig1)#** prompt displays a listing of all commands for the **gig1** interface.

Two special sections below discuss the following commands in detail:

- **WDS Lock**
- **Multicast Traffic Isolation (supports Airplay and mDNS service)**

Command	Description
<b>bond1</b>	Bond 1.
<b>bond2</b>	Bond 2.
<b>console</b>	Select the console interface. The console interface is used for management purposes only. FORMAT: <b>interface console</b>
<b>gig1</b>	Select the Gigabit 1 interface. FORMAT: <b>interface gig1</b>
<b>gig2</b>	Select the Gigabit 2 interface. FORMAT: <b>interface gig2</b>
<b>iap</b>	Select an IAP. FORMAT: <b>interface iap</b>
IAP-NAME <b>iap1, iap2</b>	IAP interface information

## WDS Lock

It is **VERY** important to use the **WDS Lock** command in CLI if you are using **WDS** and your network is being managed by any version of XMS, because XMS does not manage WDS. When XMS applies configuration changes, it resets the AP's configuration before applying the new configuration, and this can sever WDS links. To prevent this, the following CLI command must be used:

```
interface iap wds lock on
```

When WDS Lock is enabled, the AP will not make changes that can break the WDS link. Any attempt to make such changes via CLI, WMI, XMS, or SNMP will return an error. XMS-Cloud will not receive an error, but the changes will be refused. All methods of updating any part of the configuration associated with WDS are blocked when WDS Lock is enabled:

- Radio settings for radios involved with a link
- SSID settings for SSIDs involved with a link
- VLAN settings for VLANs associated with SSIDs involved with a link
- WDS settings for any active link
- Global WDS settings

Note that loading configuration files, performing a WDS reset, or using the **reset preserveip** command will also preserve WDS settings.

## Multicast Traffic Isolation (supports Airplay and mDNS service)

In today's deployments, we recommend filtering multicast traffic using [Air Cleaner](#) filters in any subnet network that has more than 500 clients. This makes technologies that rely on multicast unusable (e.g., Apple TV and printers, etc.) unless you add individual [Access Control List](#) entries per Access Point. To solve this problem, use multicast isolation. If you are using Air Cleaner filters, the multicast isolation commands will pass the desired multicasts along to the specified stations.

The ArrayOS multicast isolation feature provides control over which multicast frames are distributed in the network and how they are distributed. It supports

devices that rely on multicast and at the same time minimizes the airtime impact. Multicast traffic is blocked based on the Layer 2 multicast MAC addresses.

There are two multicast isolation commands (they are in **config iap global** mode):

```
(config)# interface iap global-settings
(config-iap-global)# multicast isolate-by {none | { access-point | ap-neighbors |
    user-group | fixed-list } }
(config-iap-global)# multicast fixed-addr { reset |
    {add | del} <addr> [ group [<grp>] ] }
(config-iap-global)# exit
```

Where:

- **multicast isolate-by access-point** takes multicasts heard on the radios and only forwards them to other devices associated to this AP.
- **multicast isolate-by ap-neighbors** takes multicasts heard on the radios and forwards them to this AP's connected stations and to this AP's neighbors (those APs within range of this AP— that can hear each other's beacons).
- **multicast isolate-by user-groups** only shares multicasts among stations that are part of the same User Group (see [“Groups” on page 310](#)).
- **multicast isolate-by fixed-list** will only allow multicasts from the wired ports to go out on radios if the source MAC address matches one of the addresses specified in the **multicast fixed-addr** list.
- **multicast fixed-addr** lists the source MAC addresses for multicasts (received on the wired ports) that are allowed to go out on the radios.

These options can be used alone, or in any combination. For example, isolating by access-point and user-group would only share multicasts between stations on the same AP and user-group. This could be used to provide access to certain services to one group of users (i.e., teachers) in a specific location without making them available to another group (i.e., students).

Specify the multicast fixed address list with the **multicast fixed-addr** command by adding or deleting MAC addresses from the list, optionally associating a user-group with each MAC address. This list can be unique to each AP, and provides a means to allow wired devices to advertise their services on specified APs.

## load

The **load** command `[MyAP(config)# load]` loads a configuration file.

Command	Description
<b>factory.conf</b>	Load the factory settings configuration file. FORMAT: <b>load [factory.conf]</b>
<b>lastboot.conf</b>	Load the configuration file from the last boot-up. FORMAT: <b>load [lastboot.conf]</b>
<b>[myfile].conf</b>	If you have saved a configuration, enter its name to load it. FORMAT: <b>load [myfile.conf]</b>
<b>saved.conf</b>	Load the configuration file with the last saved settings. FORMAT: <b>load [saved.conf]</b>

## location

The **location** command `[MyAP(config)# location]` is used to set the location descriptive string for the AP.

Command	Description
<b>&lt;cr&gt;</b>	Set the location for the AP. FORMAT: <b>location [newlocation]</b>

**location-reporting**

The **location-reporting** command [MyAP(config)# **location-reporting**] is used to configure Location Server settings. See also, “[Location](#)” on page 195.

Command	Description
<b>cust-key</b>	Set Location Server customer key. More details are supplied below this table. FORMAT: <b>location-reporting cust-key &lt;loc-server-customer-key&gt;</b>
<b>disable off</b>	Disable location-reporting. FORMAT: <b>location-reporting disable</b>
<b>enable on</b>	Enable location-reporting. FORMAT: <b>location-reporting enable</b>
<b>include-random</b>	Some devices (e.g., Apple devices) generate changing random MAC addresses. It’s preferable not to include these clients as they generate a lot of useless data. The default is <b>off</b> . FORMAT: <b>location-reporting include-random off   on</b>
<b>max-data-points</b>	Maximum number of data points per calculation. The default is 5—more than 5 isn’t recommended. FORMAT: <b>location-reporting max-data-points &lt;#&gt;</b>
<b>per-radio-data</b>	Collect and upload visitor analytic data on a per-radio basis FORMAT: <b>location-reporting per-radio-data off   on</b>
<b>period</b>	Set Location Server reporting period (seconds). FORMAT: <b>location-reporting period &lt;#-seconds&gt;</b>

Command	Description
<b>rf-finger-printing</b>	Includes data from other APs for more precise calculations. Off by default. FORMAT: <b>location-reporting rf-finger-printing on   off</b>
<b>url</b>	Set URL of Location Server. FORMAT: <b>location-reporting url &lt;loc-server-URL&gt;</b>

The optional **cust-key** setting controls encryption as follows:

- If no string is entered, data is sent to the location server unencrypted.
- If the string **MD5** or **SHA1** is entered, data is sent with that form of encryption. These satisfy the privacy requirements of the EU General Data Protection Regulation (GDPR). In particular, this assures that client device MAC addresses are encrypted when sent.
- If a Location Customer Key other than MD5 or SHA1 has been entered, data is sent encrypted using AES with that key.

To make changes take effect quickly, turn location-reporting off and on again.

**management**

The **management** command [**MyAP(config)# management**] enters management mode, where you may configure management parameters.

Command	Description
<b>&lt;cr&gt;</b>	Enter management mode. FORMAT: <b>management &lt;cr&gt;</b>

The following types of settings may be configured in management mode:

Setting	Description
<b>activation</b>	Start or stop activation server polling.
<b>banner</b>	Configure login banner messages.
<b>clear</b>	Remove/clear requested elements.
<b>cloud</b>	Enable/disable Cloud access.
<b>console</b>	Configure console management parameters.
<b>easypass</b>	Enable/disable EasyPass access to this AP. Includes settings for EasyPass server's host, port, keepalive timeout and retry count, as well as the WebSocket security scheme.
<b>fips</b>	Enable/disable FIPS 140-2, Level 2 Security. See <a href="#">"Implementing FIPS Security"</a> on page 609.
<b>help</b>	Description of the interactive help system.
<b>history</b>	Display history of commands executed.
<b>https</b>	Enable/disable HTTPS access.
<b>license</b>	Set access point software license key
<b>load</b>	Load running configuration from flash.

Setting	Description
<b>max-auth-attempts</b>	Maximum number of authentication (login) attempts (0 means unlimited).
<b>more</b>	Turn on or off terminal pagination.
<b>network-assurance</b>	Enable/disable network assurance.
<b>pci-audit</b>	Enable/disable PCI (Payment Card Industry) audit mode. See <a href="#">“Auditing PCI DSS” on page 603</a> .
<b>quick-config</b>	Apply quick configuration template.
<b>quit</b>	Exit the command line interface.
<b>reauth-period</b>	Time between failed CLI login attempts.
<b>reset-button</b>	Some AP models have a Reset button to perform a factory reset. This option can disable that button.
<b>restore</b>	Restore to previous saved config.
<b>revert</b>	Revert to saved configuration after delay if configuration not saved.
<b>save</b>	Save running configuration to flash.
<b>search</b>	Search show command output for pattern.
<b>show</b>	Display current information about the selected item.
<b>spanning-tree</b>	Enable/disable Spanning Tree Protocol.
<b>ssh</b>	Enable/disable SSH access.
<b>standby</b>	Configure standby parameters.
<b>statistics</b>	Display statistics.
<b>telnet</b>	Enable/disable telnet access.
<b>top</b>	Return to top level of configuration mode.



Setting	Description
<b>uptime</b>	Display time since last boot.
<b>xms-override</b>	Override XMS managed mode and allow local configuration changes according to your user privileges. See <a href="#">“Managing APs Locally or Using XMS” on page 89</a> .
<b>xircon</b>	Enable/disable Xircon access. See <i>Xircon User’s Guide</i> for more information.

### mdm

The **mdm** command [**MyAP(config)# mdm**] is used to configure Mobile Device Management Server settings. See also, [“Mobile” on page 407](#).

Command	Description
<b>airwatch api</b>	<p>Set Location Server customer key.</p> <p>FORMAT:</p> <p><b>mdm airwatch api</b></p> <p>The following types of settings may be configured in management mode:</p> <ul style="list-style-type: none"> <li>● <b>access-error</b> Set AirWatch API access error action</li> <li>● <b>key</b> Set AirWatch API key</li> <li>● <b>password</b> Set AirWatch API password</li> <li>● <b>poll-period</b> Set AirWatch API poll period</li> <li>● <b>timeout</b> Set AirWatch API timeout</li> <li>● <b>url</b> Set AirWatch API URL</li> <li>● <b>username</b> Set AirWatch API username</li> </ul>
<b>redirect-url</b>	<p>Set URL to redirect clients to.</p> <p>FORMAT:</p> <p><b>mdm airwatch redirect-url &lt;URL-string&gt;</b></p>

**more**

The **more** command [**MyAP(config)# more**] is used to turn terminal pagination ON or OFF.

Command	Description
<b>disable off</b>	Turn OFF terminal pagination. FORMAT: <b>more off</b>
<b>enable on</b>	Turn ON terminal pagination. FORMAT: <b>more on</b>

**netflow**

The **netflow** command [MyAP(config-netflow)#] is used to enable or disable, or configure sending IP flow information (traffic statistics) to the collector you specify.

Command	Description
<b>collector</b>	Set the Netflow collector IP address or fully qualified domain name (host.domain). Only one collector may be set. If port is not specified, the default is 2055. FORMAT: <b>netflow collector host</b> {<ip-addr>   <domain>} <b>[port &lt;port#&gt;]</b>
<b>disable</b> <b>off</b>	Disable netflow. FORMAT: <b>netflow disable</b>
<b>ipfix</b>	Enable NetFlow IPFIX probe.
<b>off</b>	Disable netflow. FORMAT: <b>netflow off</b>
<b>v5</b>	Enable NetFlow v5 probe.
<b>v9</b>	Enable Netflow v9 probe.

**no**

The **no** command [MyAP(config)# **no**] is used to disable a selected element or set the element to its default value.

Command	Description
<b>2.4GHz</b>	Disable all 2.4GHz IAPs.
<b>5GHz</b>	Disable all 5GHz IAPs.
<b>acl</b>	Disable the Access Control List. FORMAT: <b>no acl</b>
<b>clear-text</b>	Disable entry and display of passwords and secrets in the clear.
<b>gig1</b>	Disable gig1.
<b>gig2</b>	Disable gig2.
<b>https</b>	Disable https access. FORMAT: <b>no https</b>
<b>intrude-detect</b>	Disable intrusion detection. FORMAT: <b>no intrude-detect</b>
<b>management</b>	Disable management on all Ethernet interfaces. FORMAT: <b>no management</b>
<b>more</b>	Disable terminal pagination. FORMAT: <b>no more</b>
<b>ntp</b>	Disable the NTP server. FORMAT: <b>no ntp</b>

Command	Description
<b>snmp</b>	Disable SNMP features. FORMAT: <b>no snmp</b>
<b>spanning-tree</b>	Disable spanning tree.
<b>ssh</b>	Disable ssh access. FORMAT: <b>no ssh</b>
<b>syslog</b>	Disable the Syslog services. FORMAT: <b>no syslog</b>
<b>telnet</b>	Disable Telnet access. FORMAT: <b>no telnet</b>

### quick-config

The **quick-config** command is used to apply configuration templates to the AP for typical deployment scenarios.

Command	Description
<b>Classroom</b>	Configure AP for classroom deployment. FORMAT: <b>quick-config Classroom</b> Configures the AP for use in classroom settings (K-12 schools, Higher education, etc.)
<b>High-density</b>	Configure AP for high density deployment. FORMAT: <b>quick-config High-density</b> Configures the AP for use in high density settings (lecture halls, convention centers, stadiums, etc.)

**quit**

The **quit** command [MyAP(config)# **quit**] is used to exit the Command Line Interface.

Command	Description
<b>&lt;cr&gt;</b>	Exit the Command Line Interface. FORMAT: <b>quit</b> If you have made any configuration changes and your changes have not been saved, you are prompted to save your changes to Flash. At the prompt, answer <b>Yes</b> to save your changes, or answer <b>No</b> to discard your changes.

**authentication-server**

The **authentication-server** command [MyAP(config-authserver)#] is used to configure the external and internal RADIUS server parameters.

Command	Description
<b>active-directory</b>	Configure Active Directory parameters.
<b>external-radius</b>	Configure an external RADIUS server. FORMAT: <b>authentication-server external-radius</b> To configure a RADIUS server (primary, secondary, or accounting server, by IP address or host name), and the reporting interval use: <b>authentication-server external-radius accounting</b>
<b>internal-radius</b>	Configure the internal RADIUS server. FORMAT: <b>authentication-server internal-radius</b>

Command	Description
<b>use</b>	Choose the active RADIUS server (either external or internal). FORMAT: <b>authentication-server use external</b> (or internal)

**reboot**

The **reboot** command [**MyAP(config)# reboot**] is used to reboot the AP. If you have unsaved changes, the command will notify you and give you a chance to cancel the reboot.

Command	Description
<b>&lt;cr&gt;</b>	Reboot the AP. FORMAT: <b>reboot</b>
<b>delay</b>	Reboot the AP after a delay of 1 to 60 seconds. FORMAT: <b>reboot delay [n]</b>

**reset**

The **reset** command [**MyAP(config)# reset**] is used to reset all settings to their default values then reboot the AP. Proxy settings are preserved.

Command	Description
<b>&lt;cr&gt;</b>	Reset all configuration parameters to their factory default values. FORMAT: <b>reset</b> The AP is rebooted automatically.
<b>preserve-ip-settings</b>	Preserve all ethernet and VLAN settings and reset all other configuration parameters to their factory default values. FORMAT: <b>reset preserve-ip-settings</b> The AP is rebooted automatically.

Note that some AP models have a Reset button that performs a factory reset. The **management** command has a **reset-button** option that can disable this button.



### restore

The **restore** command [**MyAP(config)# restore**] is used to restore configuration to a version that was previously saved locally.

Command	Description
<b>?</b>	Use this to display the list of available config files. FORMAT: <b>restore ?</b>
<b>&lt;filename&gt;</b>	Enter the name of the locally saved configuration to restore. FORMAT: <b>restore &lt;config-filename&gt;</b>

**roaming-assist**

The **roaming-assist** command [MyAP(config)# **roaming-assist**] is used to configure roaming assistance settings. See also, “Roaming Assist” on page 388.

Command	Description
<b>data-rate</b>	Set minimum packet data rate before roaming, in Mbps. FORMAT: <b>roaming-assist data-rate &lt;1-99&gt;</b>
<b>devices</b>	Set device types or classes to assist. FORMAT: <b>roaming-assist devices all   unidentified   DEVICE-CLASS &lt;ID-string&gt;   DEVICE-TYPE &lt;ID-string&gt;</b>
<b>disable off</b>	Disable roaming assist. FORMAT: <b>roaming-assist disable</b>
<b>enable on</b>	Enable roaming assist. FORMAT: <b>roaming-assist enable</b>
<b>period</b>	Set roaming assist backoff period (seconds). FORMAT: <b>roaming-assist period &lt;#-seconds&gt;</b>
<b>threshold</b>	Set roaming RSSI threshold in db relative to RSSI of nearest AP. FORMAT: <b>roaming-assist threshold &lt;-50 to 50&gt;</b>

**run-tests**

The **run-tests** command [**MyAP(run-tests)#**] is used to enter run-tests mode, which allows you to perform a range of tests on the AP.

Command	Description
<b>@</b>	Execute command from history
<b>ad-authenticate</b>	Test domain user authentication.
<b>ad-check-secret</b>	Check machine trust secret.
<b>ad-debug-info</b>	Display detailed Active Directory information.
<b>ad-list-groups</b>	List all domain groups.
<b>ad-status</b>	Display Active Directory status.
<b>capture</b>	Execute a packet capture.
<b>clear</b>	Remove/clear requested elements.
<b>diagnostic-log</b>	Generate diagnostic log file.
<b>end</b>	Exit configuration mode.
<b>help</b>	Description of the interactive help system.
<b>history</b>	Display history of commands executed.
<b>iperf</b>	Execute iperf utility. FORMAT: <b>run-tests iperf</b>
<b>led</b>	LED test. FORMAT: <b>run-tests led [flash   rotate]</b>
<b>memtest</b>	Execute memory tests. FORMAT: <b>run-tests memtest</b>
<b>more</b>	Turn on or off terminal pagination.

Command	Description
<b>ping</b>	Execute ping utility. FORMAT: <b>run-tests ping [host-name   ip-addr]</b>
<b>quick-config</b>	Apply quick configuration template.
<b>quit</b>	Exit the command line interface.
<b>radius-ping</b>	Special ping utility to test the connection to a RADIUS server. FORMAT: <b>run-tests radius-ping [external   ssid &lt;ssidnum&gt;] [primary   secondary] user &lt;raduser&gt; password &lt;radpasswd&gt; auth-type [CHAP   PAP]</b> <b>run-tests radius-ping [internal   server &lt;radserver&gt; port &lt;radport&gt; secret &lt;radsecret&gt; ] user &lt;raduser&gt; password &lt;radpasswd&gt; auth-type [CHAP   PAP]</b> You may select a RADIUS server that you have already configured ( <b>ssid</b> or <b>external</b> or <b>internal</b> ) or specify another <b>server</b> .
<b>restore</b>	Restore to previous saved configuration.
<b>revert</b>	Revert to saved configuration after delay if configuration is not saved.
<b>save</b>	Save running configuration to flash.
<b>search</b>	Search show command output for pattern.
<b>show</b>	Display current information about the selected item.
<b>site-survey</b>	Enable or disable site survey mode. FORMAT: <b>run-tests site-survey [on   off   enable   disable]</b>

Command	Description
<b>ssh</b>	Execute ssh utility. FORMAT: <b>run-tests ssh [hostname   ip-addr] [command-line-switches (optional)]</b>
<b>tcpdump</b>	Execute tcpdump utility to dump traffic for selected interface or VLAN. Supports 802.11 headers. FORMAT: <b>run-tests tcpdump</b>
<b>telnet</b>	Execute telnet utility. FORMAT: <b>run-tests telnet [hostname   ip-addr] [command-line-switches (optional)]</b>
<b>traceroute</b>	Execute traceroute utility. FORMAT: <b>run-tests traceroute [host-name   ip-addr]</b>
<b>uptime</b>	Display time since last boot.

### security

The **security** command [**MyAP(config-security)#**] is used to establish the security parameters for the AP.

Command	Description
<b>wep</b>	Set the WEP encryption parameters. FORMAT: <b>security wep</b>
<b>wpa</b>	Set the WEP encryption parameters. FORMAT: <b>security wpa</b>

## snmp

The **snmp** command [MyAP(config-snm)#] is used to enable, disable, or configure SNMP.

Command	Description
<b>trap</b>	Configure traps for SNMP. Up to four trap destinations may be configured, and you may specify whether to send traps for authentication failure. FORMAT: <b>snmp trap</b>
<b>v2</b>	Enable SNMP v2. FORMAT: <b>snmp v2</b>
<b>v3</b>	Enable SNMP v3. FORMAT: <b>snmp v3</b>

**ssid**

The **ssid** command [MyAP(config-ssid)#] is used to establish your SSID parameters. Special sections below discuss [Fast Transition Configuration \(dot11r\)](#) and [Web Page Redirect—HTTPS Pass-through for Facebook Wi-Fi](#).

Command	Description
<b>add</b>	Add an SSID. FORMAT: <b>ssid add [newssid]</b>
<b>del</b>	Delete an SSID. FORMAT: <b>ssid del [oldssid]</b>
<b>edit</b>	Edit an existing SSID. FORMAT: <b>ssid edit [existingssid]</b>
<b>reset</b>	Delete all SSIDs and restore the default SSID. FORMAT: <b>ssid reset</b>
<b>stations</b>	Set station limit for this SSID.
<b>traffic</b>	Set traffic limits for this SSID

**Fast Transition Configuration (dot11r)**

Fast Transition (FT) Roaming (IEEE802.11r) reduces the time it takes a station to roam from one AP to another by pre-authenticating the station to neighboring APs. This is especially useful for sensitive voice-enabled clients, allowing them to roam more smoothly and reliably.



*Before configuring this feature, verify that your user population includes roaming voice-enabled 802.11r devices that will use it, since such devices are not that common.*

FT requires 802.11k to be on (see [“Global Settings \(IAPs\)”](#) on page 325), and WPA2 authentication (see [“Global Settings \(Security\)”](#) on page 255 and [“SSID Management”](#) on page 283).

FT is enabled or disabled per SSID. All Riverbed APs running ArrayOS share the same predefined mobility domain. Note that fast transition operates between APs running ArrayOS, and separately between APs running AOSLite, but it does not inter-operate between APs running the two different operating systems.

Use the following command to enable 802.11r fast transition.

```
(config-ssid-mySSID)# dot11r on
```

### **Web Page Redirect—HTTPS Pass-through for Facebook Wi-Fi**

This setting for web page redirect allows all HTTPS traffic through whether a station is captured or not. HTTPS pass-through is **required for captive portals that integrate with Facebook**. It allows users to check in to the Facebook page of a business that they are visiting in order to get internet access.

You can also use pass-through to provide a better user experience. Although it is more permissive for allowing traffic (users will only be redirected when they go to a non-encrypted page), they will not receive a certificate warning when an HTTPS page is redirected.

The HTTPS pass-through setting applies to the web page redirect feature for the selected SSID. See [“SSIDs”](#) on page 274 and [“Web Page Redirect \(Captive Portal Configuration\)”](#) on page 293) for more information about SSIDs and options.

Use the following command to enable HTTPS pass-through.

```
(config-ssid-mySSID)# web-page https-passthru on
```



**syslog**

The **syslog** command **[MyAP(config-syslog)#]** is used to enable, disable, or configure the Syslog server.

Command	Description
<b>console</b>	Enable or disable the display of Syslog messages on the console, and set the level to be displayed. All messages at this level and lower (i.e., more severe) will be displayed. FORMAT: <b>syslog console [on/off] level [0-7]</b>
<b>disable off</b>	Disable the Syslog server. FORMAT: <b>syslog disable</b>
<b>email</b>	Disable the Syslog server. FORMAT: <b>syslog email from [email-from-address] level [0-7] password [email-acct-password] server [email-server-IPaddr] test [test-msg-text] to-list [recipient-email-addresses] user [email-acct-username]</b>
<b>enable on</b>	Enable the Syslog server. FORMAT: <b>syslog enable</b>
<b>local-file</b>	Set the size and/or severity level (all messages at this level and lower will be logged). FORMAT: <b>syslog local-file size [1-500] level [0-7]</b>
<b>no</b>	Disable the selected feature. FORMAT: <b>syslog no [feature]</b>

Command	Description
<b>primary</b>	Set the IP address of the primary Syslog server and/or the severity level of messages to be logged. FORMAT: <b>syslog primary [1.2.3.4] level [0-7]</b>
<b>secondary</b>	Set the IP address of the secondary (backup) Syslog server and/or the severity level of messages to be logged. FORMAT: <b>syslog primary [1.2.3.4] level [0-7]</b>
<b>sta-format</b>	Select format of station information in Syslog messages.
<b>sta-url-log</b>	Enable or disable station URL logging.
<b>tertiary</b>	Set Tertiary Syslog Server parameters.
<b>time-format</b>	Select format of date/time information in Syslog messages.

## tunnel

The **tunnel** command [MyAP(config-tunnel)#] is used to establish your tunnel parameters.

Command	Description
<b>add</b>	Add a tunnel. FORMAT: <b>tunnel add [newtunnel]</b>
<b>delete</b>	Delete a tunnel. FORMAT: <b>tunnel delete [oldtunnel]</b>

Command	Description
<b>edit</b>	Modify an existing tunnel. FORMAT: <b>tunnel edit [existingtunnel]</b>
<b>reset</b>	Delete all existing tunnels. FORMAT: <b>tunnel reset</b>

### uptime

The **uptime** command [MyAP(config)# **uptime**] is used to display the elapsed time since you last rebooted the AP.

Command	Description
<b>continuous</b>	Continuously update information.
<b>&lt;cr&gt;</b>	Display time since last reboot. FORMAT: <b>uptime</b>

## vlan

The **vlan** command [MyAP(config-vlan)#] is used to establish your VLAN parameters.

Command	Description
<b>add</b>	Add a VLAN. FORMAT: <b>vlan add [newvlan]</b>
<b>default-route</b>	Assign a VLAN for the default route (for outbound management traffic). FORMAT: <b>vlan default-route [defaultroute]</b>
<b>delete</b>	Delete a VLAN. FORMAT: <b>vlan delete [oldvlan]</b>
<b>edit</b>	Modify an existing VLAN. FORMAT: <b>vlan edit [existingvlan]</b>
<b>native-vlan</b>	Assign a native VLAN (traffic is untagged). FORMAT: <b>vlan native-vlan [nativevlan]</b>
<b>no</b>	Disable the selected feature. FORMAT: <b>vlan no [feature]</b>
<b>reset</b>	Delete all existing VLANs. FORMAT: <b>vlan reset</b>

**wifi-tag**

The **wifi-tag** command [MyAP(config-wifi-tag)#] is used to enable or disable Wi-Fi tag capabilities. When enabled, the AP listens for and collects information about Wi-Fi RFID tags sent on the designated channels. See also “Wi-Fi Tag” on page 194.

Command	Description
<b>disable off</b>	Disable wifi-tag. FORMAT: <b>wifi-tag disable</b>
<b>enable on</b>	Enable wifi-tag. FORMAT: <b>wifi-tag enable</b>
<b>refresh</b>	Disable and enable WiFi tag.
<b>server</b>	Set hostname or IP address of the tag server.
<b>tag-channel-bg</b>	Set an 802.11b or g channel for listening for tags. FORMAT: <b>wifi-tag tag-channel-bg &lt;1-255&gt;</b>
<b>udp-port</b>	Set the UDP port which a tagging server will use to query the AP for tagging information. FORMAT: <b>wifi-tag udp-port &lt;1025-65535&gt;</b>

## Sample Configuration Tasks

This section provides examples of some of the common configuration tasks used with the Wireless AP, including:

- [“Configuring a Simple Open Global SSID” on page 507.](#)
- [“Configuring a Global SSID using WPA-PEAP” on page 508.](#)
- [“Configuring an SSID-Specific SSID using WPA-PEAP” on page 509.](#)
- [“Enabling Global IAPs” on page 510.](#)
- [“Disabling Global IAPs” on page 511.](#)
- [“Enabling a Specific IAP” on page 512.](#)
- [“Disabling a Specific IAP” on page 513.](#)
- [“Setting Cell Size Auto-Configuration for All IAPs” on page 514](#)
- [“Setting the Cell Size for All IAPs” on page 515.](#)
- [“Setting the Cell Size for a Specific IAP” on page 516.](#)
- [“Configuring VLANs on an Open SSID” on page 517.](#)
- [“Configuring Radio Assurance Mode \(Loopback Tests\)” on page 518.](#)

To facilitate the accurate and timely management of revisions to this section, the examples shown here are presented as screen images taken from a Secure Shell (SSH) session (in this case, PuTTY). Depending on the application you are using to access the Command Line Interface, and how your session is set up (for example, font and screen size), the images presented on your screen may be different than the images shown in this section. However, the data displayed will be the same.

Some of the screen images shown in this section have been modified for clarity. For example, the image may have been “elongated” to show all data without the need for additional images or scrolling. We recommend that you use the Adobe PDF version of this User’s Guide when reviewing these examples—a hard copy document may be difficult to read.

As mentioned previously, the root command prompt is determined by the host name assigned to your AP.

## Configuring a Simple Open Global SSID

This example shows you how to configure a simple open global SSID.

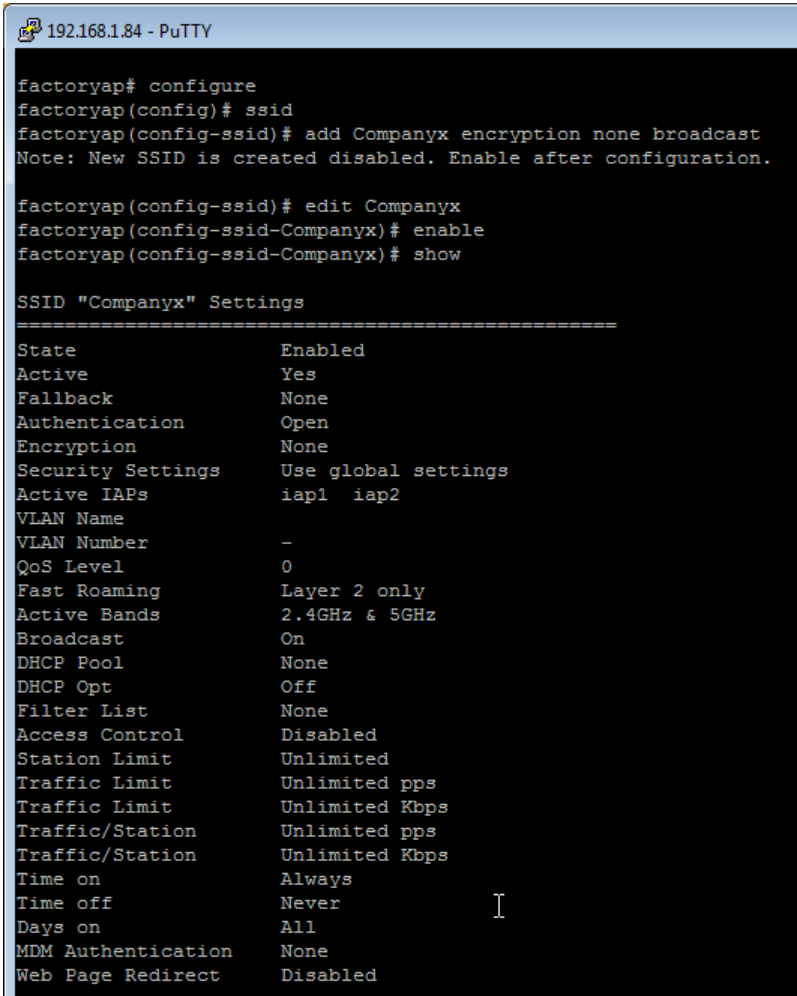

```
192.168.1.84 - PuTTY
factoryap# configure
factoryap(config)# ssid
factoryap(config-ssid)# add Companyx encryption none broadcast
Note: New SSID is created disabled. Enable after configuration.

factoryap(config-ssid)# edit Companyx
factoryap(config-ssid-Companyx)# enable
factoryap(config-ssid-Companyx)# show

SSID "Companyx" Settings
=====
State           Enabled
Active          Yes
Fallback        None
Authentication  Open
Encryption      None
Security Settings Use global settings
Active IAPs     iap1 iap2
VLAN Name       -
VLAN Number     -
QoS Level       0
Fast Roaming    Layer 2 only
Active Bands    2.4GHz & 5GHz
Broadcast       On
DHCP Pool       None
DHCP Opt        Off
Filter List     None
Access Control  Disabled
Station Limit   Unlimited
Traffic Limit   Unlimited pps
Traffic Limit   Unlimited Kbps
Traffic/Station Unlimited pps
Traffic/Station Unlimited Kbps
Time on         Always
Time off        Never
Days on         All
MDM Authentication None
Web Page Redirect Disabled
```

Figure 212. Configuring a Simple Open Global SSID

## Configuring a Global SSID using WPA-PEAP

This example shows you how to configure a global SSID using WPA-PEAP encryption in conjunction with the AP's Internal RADIUS server.

```
Xirrus Wi-Fi Array
Xirrus Wi-Fi Array
ArrayOS Version 3.0-420
Copyright (c) 2005-2007 Xirrus, Inc.
http://www.xirrus.com

Username: admin
Password: *****

Xirrus_Wi-Fi_Array# configure
Xirrus_Wi-Fi_Array(config)# ssid
Xirrus_Wi-Fi_Array(config-ssid)# add Companyx encryption wpa broadcast
Note: New SSID is created disabled. Enable after configuration.

Xirrus_Wi-Fi_Array(config-ssid)# edit Companyx
Xirrus_Wi-Fi_Array(config-ssid-Companyx)# show

SSID "Companyx" Settings
=====
State                Disabled
Active               No
Encryption           Global WPA
VLAN Name            -
VLAN Number          -
QoS Level            2
Active Band           802.11a & 802.11bg
Broadcast            On
DHCP Pool            none
Traffic Limit        Unlimited
Traffic/Station      Unlimited
Time on              Always
Time off             Never
Days on              All
Web Page Redirect    Disabled

Xirrus_Wi-Fi_Array(config-ssid-Companyx)# top
Xirrus_Wi-Fi_Array(config)# radius-server use internal
Xirrus_Wi-Fi_Array(config)# radius-server internal add Mike password Jones ssid Companyx
Xirrus_Wi-Fi_Array(config)# radius-server internal
Xirrus_Wi-Fi_Array(config-radius-internal)# show

Username                SSID
-----                -
Mike                    Companyx

Xirrus_Wi-Fi_Array(config-radius-internal)# save
Xirrus_Wi-Fi_Array(config-radius-internal)# top
Xirrus_Wi-Fi_Array(config)# security wpa
Xirrus_Wi-Fi_Array(config-security-wpa)# show

Global Security Settings Summary
-----
WEP:  key 1 size : not set (default)
      key 2 size : not set
      key 3 size : not set
      key 4 size : not set

WPA:  cipher      : TKIP on, AES off
      key mgmt    : EAP on, PSK off
      rekey time  : disabled
      passphrase  : not set
```

Figure 213. Configuring a Global SSID using WPA-PEAP



## Configuring an SSID-Specific SSID using WPA-PEAP

This example shows you how to configure an SSID-specific SSID using WPA-PEAP encryption in conjunction with the AP's Internal RADIUS server.

```
Xirrus Wi-Fi Array
Xirrus Wi-Fi Array
ArrayOS Version 3.0-420
Copyright (c) 2005-2007 Xirrus, Inc.
http://www.xirrus.com

Username: admin
Password: *****

Xirrus_Wi-Fi_Array# configure
Xirrus_Wi-Fi_Array(config)# ssid
Xirrus_Wi-Fi_Array(config-ssid)# add Companyx encryption wpa ssid_specific broadcast
Note: New SSID is created disabled. Enable after configuration.

Xirrus_Wi-Fi_Array(config-ssid)# edit Companyx
Xirrus_Wi-Fi_Array(config-ssid-Companyx)# radius-server use internal
Xirrus_Wi-Fi_Array(config-ssid-Companyx)# radius-server internal add Mike password J
Xirrus_Wi-Fi_Array(config-ssid-Companyx)# enable
sXirrus_Wi-Fi_Array(config-ssid-Companyx)# show

SSID "Companyx" Settings
=====
State                Enabled
Active               Yes
Encryption           SSID specific WPA
VLAN Name
VLAN Number         -
QoS Level           2
Active Band          802.11a & 802.11bg
Broadcast            On
DHCP Pool            none
Traffic Limit        Unlimited
Traffic/Station      Unlimited
Time on              Always
Time off             Never
Days on              All
Web Page Redirect    Disabled

SSID Specific WPA Security Settings
-----
Key Management        EAP on, PSK off
PSK Passphrase        not set
Radius Server         internal

Xirrus_Wi-Fi_Array(config-ssid-Companyx)# top
Xirrus_Wi-Fi_Array(config)# radius-server internal
Xirrus_Wi-Fi_Array(config-radius-internal)# show

Username              SSID
-----              ----
Mike                  Companyx

Xirrus_Wi-Fi_Array(config-radius-internal)# save
Xirrus_Wi-Fi_Array(config-radius-internal)#
```

Figure 214. Configuring an SSID-Specific SSID using WPA-PEAP

## Enabling Global IAPs

This example shows you how to enable all IAPs (radios), regardless of the wireless technology they use.

```
Xirrus Wi-Fi Array
Xirrus Wi-Fi Array
ArrayOS Version 3.0-420
Copyright (c) 2005-2007 Xirrus, Inc.
http://www.xirrus.com

Username: admin
Password: *****

Xirrus_Wi-Fi_Array# configure
Xirrus_Wi-Fi_Array(config)# interface iap
Xirrus_Wi-Fi_Array(config-iap)# global_settings
Xirrus_Wi-Fi_Array(config-iap-global)# all_up
Interface IAP a1 state changed to up
Interface IAP a3 state changed to up
Interface IAP a4 state changed to up
Interface IAP a5 state changed to up
Interface IAP a6 state changed to up
Interface IAP a7 state changed to up
Interface IAP a8 state changed to up
Interface IAP a9 state changed to up
Interface IAP a10 state changed to up
Interface IAP a11 state changed to up
Interface IAP a12 state changed to up
Interface IAP abg2 state changed to up
Interface IAP abg3 state changed to up
Interface IAP abg4 state changed to up

Xirrus_Wi-Fi_Array(config-iap-global)# save
Xirrus_Wi-Fi_Array(config-iap-global)# exit
Xirrus_Wi-Fi_Array(config-iap)# show

IAP Summary Table

```

IAP	State	Channel	Antenna	Cell Size	TX Power	RX Threshold	Stations	WDS MAC address / BSSID	Description
a1	up	64	int-dir	max	20dBm	-90dBm	0	C-1 00:0f:7d:03:5e:10-11	
a2	up	48	int-dir	max	20dBm	-90dBm	0	C-2 00:0f:7d:03:5e:30-31	
a3	up	157	int-dir	max	20dBm	-90dBm	0	C-3 00:0f:7d:03:5e:40-41	
a4	up	60	int-dir	max	20dBm	-90dBm	0	00:0f:7d:03:5e:50-51	
a5	up	44	int-dir	max	20dBm	-90dBm	0	00:0f:7d:03:5e:70-71	
a6	up	153	int-dir	max	20dBm	-90dBm	0	00:0f:7d:03:5d:80-81	
a7	up	56	int-dir	max	20dBm	-90dBm	0	00:0f:7d:03:5d:90-91	
a8	up	40	int-dir	max	20dBm	-90dBm	0	00:0f:7d:03:5d:b0-b1	
a9	up	149	int-dir	max	20dBm	-90dBm	0	00:0f:7d:03:5d:c0-c1	
a10	up	52	int-dir	max	20dBm	-90dBm	0	00:0f:7d:03:5d:d0-d1	

Figure 215. Enabling Global IAPs

## Disabling Global IAPs

This example shows you how to disable all IAPs (radios), regardless of the wireless technology they use.

```
Xirrus Wi-Fi Array
Xirrus Wi-Fi Array
ArrayOS Version 3.0-420
Copyright (c) 2005-2007 Xirrus, Inc.
http://www.xirrus.com

Username: admin
Password: *****

Xirrus_Wi-Fi_Array# configure
Xirrus_Wi-Fi_Array(config)# interface iap
Xirrus_Wi-Fi_Array(config-iap)# global_settings
Xirrus_Wi-Fi_Array(config-iap-global)# all_down
  Interface IAP a1 state changed to down
  Interface IAP a2 state changed to down
  Interface IAP a3 state changed to down
  Interface IAP a4 state changed to down
  Interface IAP a5 state changed to down
  Interface IAP a6 state changed to down
  Interface IAP a7 state changed to down
  Interface IAP a8 state changed to down
  Interface IAP a9 state changed to down
  Interface IAP a10 state changed to down
  Interface IAP a11 state changed to down
  Interface IAP a12 state changed to down
  Interface IAP abg1 state changed to down
  Interface IAP abg2 state changed to down
  Interface IAP abg3 state changed to down
  Interface IAP abg4 state changed to down

Xirrus_Wi-Fi_Array(config-iap-global)# save
Xirrus_Wi-Fi_Array(config-iap-global)# exit
Xirrus_Wi-Fi_Array(config-iap)# show

IAP Summary Table
```

	Cell	TX	RX							
IAP State	Channel	Antenna	Size	Power	Threshold	Stations	WDS	MAC address	/ BSSID	Description
a1	down	64	int-dir	max	20dBm	-90dBm	0	C-1	00:0f:7d:03:5e:10-11	
a2	down	48	int-dir	max	20dBm	-90dBm	0	C-2	00:0f:7d:03:5e:30-31	
a3	down	157	int-dir	max	20dBm	-90dBm	0	C-3	00:0f:7d:03:5e:40-41	
a4	down	60	int-dir	max	20dBm	-90dBm	0		00:0f:7d:03:5e:50-51	
a5	down	44	int-dir	max	20dBm	-90dBm	0		00:0f:7d:03:5e:70-71	
a6	down	153	int-dir	max	20dBm	-90dBm	0		00:0f:7d:03:5d:80-81	
a7	down	56	int-dir	max	20dBm	-90dBm	0		00:0f:7d:03:5d:90-91	
a8	down	40	int-dir	max	20dBm	-90dBm	0		00:0f:7d:03:5d:b0-b1	
a9	down	149	int-dir	max	20dBm	-90dBm	0		00:0f:7d:03:5d:c0-c1	

Figure 216. Disabling Global IAPs

## Enabling a Specific IAP

This example shows you how to enable a specific IAP (radio). In this example, the IAP that is being enabled is **a1** (the first IAP in the summary list).

```
Xirrus Wi-Fi Array
Xirrus Wi-Fi Array
ArrayOS Version 3.0-420
Copyright (c) 2005-2007 Xirrus, Inc.
http://www.xirrus.com

Username: admin
Password: *****

Xirrus_Wi-Fi_Array# configure
Xirrus_Wi-Fi_Array(config)# interface iap
Xirrus_Wi-Fi_Array(config-iap)# a1 up
Xirrus_Wi-Fi_Array(config-iap)# save
Xirrus_Wi-Fi_Array(config-iap)# show
```

IAP Summary Table										
IAP	State	Channel	Antenna	Cell	TX	RX	Stations	WDS	MAC address / BSSID	Description
a1	up	64	int-dir	max	20dBm	-90dBm	0	C-1	00:0f:7d:03:5e:10-11	
a2	down	48	int-dir	max	20dBm	-90dBm	0	C-2	00:0f:7d:03:5e:30-31	
a3	down	157	int-dir	max	20dBm	-90dBm	0	C-3	00:0f:7d:03:5e:40-41	
a4	down	60	int-dir	max	20dBm	-90dBm	0		00:0f:7d:03:5e:50-51	
a5	down	44	int-dir	max	20dBm	-90dBm	0		00:0f:7d:03:5e:70-71	
a6	down	153	int-dir	max	20dBm	-90dBm	0		00:0f:7d:03:5d:80-81	
a7	down	56	int-dir	max	20dBm	-90dBm	0		00:0f:7d:03:5d:90-91	
a8	down	40	int-dir	max	20dBm	-90dBm	0		00:0f:7d:03:5d:b0-b1	
a9	down	149	int-dir	max	20dBm	-90dBm	0		00:0f:7d:03:5d:c0-c1	
a10	down	52	int-dir	max	20dBm	-90dBm	0		00:0f:7d:03:5d:d0-d1	
a11	down	36	int-dir	max	20dBm	-90dBm	0		00:0f:7d:03:5d:f0-f1	
a12	down	161	int-dir	max	20dBm	-90dBm	0		00:0f:7d:03:5e:00-01	
abg1	down	11	int-dir	max	20dBm	-90dBm	0		00:0f:7d:03:5e:20-21	
abg2	down	monitor	int-omni	manual	20dBm	-95dBm	0		00:0f:7d:03:5e:60-61	
abg3	down	6	int-dir	max	20dBm	-90dBm	0		00:0f:7d:03:5d:a0-a1	

Figure 217. Enabling a Specific IAP

## Disabling a Specific IAP

This example shows you how to disable a specific IAP (radio). In this example, the IAP that is being disabled is **a2** (the second IAP in the summary list).

```
Xirrus Wi-Fi Array
Xirrus Wi-Fi Array
ArrayOS Version 3.0-420
Copyright (c) 2005-2007 Xirrus, Inc.
http://www.xirrus.com

Username: admin
Password: *****

Xirrus_Wi-Fi_Array# configure
Xirrus_Wi-Fi_Array(config)# interface iap
Xirrus_Wi-Fi_Array(config-iap)# a2 down
Xirrus_Wi-Fi_Array(config-iap)# save
Xirrus_Wi-Fi_Array(config-iap)# show
```

IAP Summary Table										
IAP	State	Channel	Antenna	Cell	TX	RX	Stations	WDS	MAC address / BSSID	Descripti
a1	up	64	int-dir	max	20dBm	-90dBm	0	C-1	00:0f:7d:03:5e:10-11	
a2	down	48	int-dir	max	20dBm	-90dBm	0	C-2	00:0f:7d:03:5e:30-31	
a3	up	157	int-dir	max	20dBm	-90dBm	0	C-3	00:0f:7d:03:5e:40-41	
a4	up	60	int-dir	max	20dBm	-90dBm	0		00:0f:7d:03:5e:50-51	
a5	up	44	int-dir	max	20dBm	-90dBm	0		00:0f:7d:03:5e:70-71	
a6	up	153	int-dir	max	20dBm	-90dBm	0		00:0f:7d:03:5d:80-81	
a7	up	56	int-dir	max	20dBm	-90dBm	0		00:0f:7d:03:5d:90-91	
a8	up	40	int-dir	max	20dBm	-90dBm	0		00:0f:7d:03:5d:b0-b1	
a9	up	149	int-dir	max	20dBm	-90dBm	0		00:0f:7d:03:5d:c0-c1	
a10	up	52	int-dir	max	20dBm	-90dBm	0		00:0f:7d:03:5d:d0-d1	
a11	up	36	int-dir	max	20dBm	-90dBm	0		00:0f:7d:03:5d:f0-f1	
a12	up	161	int-dir	max	20dBm	-90dBm	0		00:0f:7d:03:5e:00-01	
abg1	up	11	int-dir	max	20dBm	-90dBm	0		00:0f:7d:03:5e:20-21	
abg2	up	monitor	int-omni	manual	20dBm	-95dBm	0		00:0f:7d:03:5e:60-61	
abg3	up	6	int-dir	max	20dBm	-90dBm	0		00:0f:7d:03:5d:a0-a1	
aba4	up	1	int-dir	max	20dBm	-90dBm	0		00:0f:7d:03:5d:e0-e1	

Figure 218. Disabling a Specific IAP

## Setting Cell Size Auto-Configuration for All IAPs

This example shows how to set the cell size for all enabled IAPs to be auto-configured (**auto**). (See “Fine Tuning Cell Sizes” on page 41.) The **auto\_cell** option may be used with **global\_settings**, **global\_a\_settings**, or **global\_bg\_settings**. It sets the cell size of the specified IAPs to **auto**, and it launches an auto-configuration to adjust the sizes. Be aware that if the **intrude-detect** feature is enabled on the **monitor** radio, its cell size is unaffected by this command. Also, any IAPs used in WDS links are unaffected.

Auto-configuration may be set to run periodically at intervals specified by **auto\_cell period** (in seconds) if **period** is non-zero. The percentage of overlap allowed between cells in the cell size computation is specified by **auto\_cell overlap** (0 to 100). This example sets auto-configuration to run every 1200 seconds with an allowed overlap of 5%.

```

192.168.39.125 - PuTTY
Xirrus-WiFi-Array# config
Xirrus-WiFi-Array(config)# interface iap
Xirrus-WiFi-Array(config-iap)# global_settings
Xirrus-WiFi-Array(config-iap-global)# auto_cell overlap 5
Xirrus-WiFi-Array(config-iap-global)# auto_cell period 1200
Xirrus-WiFi-Array(config-iap-global)# auto_cell
Auto cell size configuration completed successfully.

Xirrus-WiFi-Array(config-iap-global)# save
Xirrus-WiFi-Array(config-iap-global)# exit
Xirrus-WiFi-Array(config-iap)# show

IAP Summary Table
-----
IAP State Channel Antenna Cell Size TX Power RX Power Stations WDS MAC address / BSSID Description
-----
a1 down 36 int-dir max 20dBm -90dBm 0 00:0f:7d:03:c3:10
a2 up 36 int-dir auto -10dBm -65dBm 0 00:0f:7d:03:c3:30
a3 up 157 int-dir auto -10dBm -65dBm 0 00:0f:7d:03:c3:40
a4 up 56 int-dir auto -10dBm -65dBm 0 00:0f:7d:03:c3:50
a5 down 56 int-dir max 20dBm -90dBm 0 00:0f:7d:03:c3:70
a6 down 157 int-dir max 20dBm -90dBm 0 00:0f:7d:03:c3:80
a7 down 44 int-dir max 20dBm -90dBm 0 00:0f:7d:03:c3:90
a8 down 60 int-dir max 20dBm -90dBm 0 00:0f:7d:03:c3:b0
a9 up 153 int-dir auto -10dBm -65dBm 0 00:0f:7d:03:c3:c0
a10 down 48 int-dir max 20dBm -90dBm 0 00:0f:7d:03:c3:d0
a11 down 64 int-dir max 20dBm -90dBm 0 00:0f:7d:03:c3:f0
a12 down 161 int-dir max 20dBm -90dBm 0 00:0f:7d:03:c3:00
abg1 down 1 int-dir max 20dBm -90dBm 0 00:0f:7d:03:c3:20
abg2 up monitor int-omni manual 20dBm -95dBm 0 00:0f:7d:03:c3:60
abg3 down 11 int-dir max 20dBm -90dBm 0 00:0f:7d:03:c3:a0
abg4 down 6 int-dir max 20dBm -90dBm 0 00:0f:7d:03:c3:e0

Xirrus-WiFi-Array(config-iap)#

```

Figure 219. Setting Cell Size Auto-Configuration for All IAPs

## Setting the Cell Size for All IAPs

This example shows you how to establish the cell size for all IAPs (radios), regardless of the wireless technology they use. Be aware that if the **intrude-detect** feature is enabled on the monitor radio the cell size cannot be set globally—you must first disable the intrude-detect feature on the monitor radio.

In this example, the cell size is being set to **small** for all IAPs. You have the option of setting IAP cell sizes to small, medium, large, or max. See also, “[Fine Tuning Cell Sizes](#)” on page 41.

```
Xirrus Wi-Fi Array
Xirrus Wi-Fi Array
ArrayOS Version 3.0-420
Copyright (c) 2005-2007 Xirrus, Inc.
http://www.xirrus.com

Username: admin
Password: *****

Xirrus_Wi-Fi_Array# configure
Xirrus_Wi-Fi_Array(config)# interface iap
Xirrus_Wi-Fi_Array(config-iap)# global_settings
Xirrus_Wi-Fi_Array(config-iap-global)# cellsize small
Xirrus_Wi-Fi_Array(config-iap-global)# save
Xirrus_Wi-Fi_Array(config-iap-global)# exit
Xirrus_Wi-Fi_Array(config-iap)# show
```

IAP Summary Table										
IAP	State	Channel	Antenna	Cell Size	TX Power	RX Threshold	Stations	WDS	MAC address / BSSID	Description
a1	up	64	int-dir	small	5dBm	-75dBm	0	C-1	00:0f:7d:03:5e:10-11	
a2	up	48	int-dir	small	5dBm	-75dBm	0	C-2	00:0f:7d:03:5e:30-31	
a3	up	157	int-dir	small	5dBm	-75dBm	0	C-3	00:0f:7d:03:5e:40-41	
a4	up	60	int-dir	small	5dBm	-75dBm	0		00:0f:7d:03:5e:50-51	
a5	up	44	int-dir	small	5dBm	-75dBm	0		00:0f:7d:03:5e:70-71	
a6	up	153	int-dir	small	5dBm	-75dBm	0		00:0f:7d:03:5d:80-81	
a7	up	56	int-dir	small	5dBm	-75dBm	0		00:0f:7d:03:5d:90-91	
a8	up	40	int-dir	small	5dBm	-75dBm	0		00:0f:7d:03:5d:b0-b1	
a9	up	149	int-dir	small	5dBm	-75dBm	0		00:0f:7d:03:5d:c0-c1	
a10	up	52	int-dir	small	5dBm	-75dBm	0		00:0f:7d:03:5d:d0-d1	
a11	up	36	int-dir	small	5dBm	-75dBm	0		00:0f:7d:03:5d:f0-f1	
a12	up	161	int-dir	small	5dBm	-75dBm	0		00:0f:7d:03:5e:00-01	

Figure 220. Setting the Cell Size for All IAPs

## Setting the Cell Size for a Specific IAP

This example shows you how to establish the cell size for a specific IAP (radio). In this example, the cell size for **a2** is being set to **medium**. You have the option of setting IAP cell sizes to small, medium, large, or max (the default is max). See also, “Fine Tuning Cell Sizes” on page 41.

```
Xirrus Wi-Fi Array
Xirrus Wi-Fi Array
ArrayOS Version 3.0-420
Copyright (c) 2005-2007 Xirrus, Inc.
http://www.xirrus.com

Username: admin
Password: *****

Running configuration has not been saved.

Xirrus_Wi-Fi_Array# configure
Xirrus_Wi-Fi_Array(config)# interface iap
Xirrus_Wi-Fi_Array(config-iap)# a2
Xirrus_Wi-Fi_Array(config-iap-a2)# cellsize medium
Xirrus_Wi-Fi_Array(config-iap-a2)# save
Xirrus_Wi-Fi_Array(config-iap-a2)# exit
Xirrus_Wi-Fi_Array(config-iap)# show
```

IAP Summary Table

IAP	State	Channel	Antenna	Cell Size	TX Power	RX Power	Stations	WDS	MAC address / BSSID	Description
a1	up	64	int-dir	max	20dBm	-90dBm	0	C-1	00:0f:7d:03:5e:10-11	
a2	up	48	int-dir	medium	11dBm	-81dBm	0	C-2	00:0f:7d:03:5e:30-31	
a3	up	157	int-dir	max	20dBm	-90dBm	0	C-3	00:0f:7d:03:5e:40-41	
a4	up	60	int-dir	max	20dBm	-90dBm	0		00:0f:7d:03:5e:50-51	
a5	up	44	int-dir	max	20dBm	-90dBm	0		00:0f:7d:03:5e:70-71	
a6	up	153	int-dir	max	20dBm	-90dBm	0		00:0f:7d:03:5d:80-81	
a7	up	56	int-dir	max	20dBm	-90dBm	0		00:0f:7d:03:5d:90-91	
a8	up	40	int-dir	max	20dBm	-90dBm	0		00:0f:7d:03:5d:b0-b1	
a9	up	149	int-dir	max	20dBm	-90dBm	0		00:0f:7d:03:5d:c0-c1	
a10	up	52	int-dir	max	20dBm	-90dBm	0		00:0f:7d:03:5d:d0-d1	
a11	up	36	int-dir	max	20dBm	-90dBm	0		00:0f:7d:03:5d:f0-f1	
a12	up	161	int-dir	max	20dBm	-90dBm	0		00:0f:7d:03:5e:00-01	
abg1	up	11	int-dir	max	20dBm	-90dBm	0		00:0f:7d:03:5e:20-21	

Figure 221. Setting the Cell Size for a Specific IAP



## Configuring VLANs on an Open SSID

This example shows you how to configure VLANs on an Open SSID.

```
Xirrus Wi-Fi Array

Xirrus Wi-Fi Array
ArrayOS Version 3.0-420
Copyright (c) 2005-2007 Xirrus, Inc.
http://www.xirrus.com

Username: admin
Password: *****

Xirrus_Wi-Fi_Array# configure
Xirrus_Wi-Fi_Array(config)# vlan
Xirrus_Wi-Fi_Array(config-vlan)# add VLAN2301 number 2301 ip addr 192.168.39.100 mask 255.255.255.0 gateway
Changing IP address to 192.168.39.100.
Do you want to proceed? [yes/no]: y
Xirrus_Wi-Fi_Array(config-vlan)# show

VLAN Summary Table

VLAN Name          Number  Management  DHCP   IP Address      IP Mask          IP Gateway
-----
VLAN2301           2301    disallowed  disabled  192.168.39.100  255.255.255.0   192.168.39.1

Default Route      VLAN: none
Native (untagged) VLAN: none

Xirrus_Wi-Fi_Array(config-vlan)# default-route 2301
Xirrus_Wi-Fi_Array(config-vlan)# show

VLAN Summary Table

VLAN Name          Number  Management  DHCP   IP Address      IP Mask          IP Gateway
-----
VLAN2301           2301    disallowed  disabled  192.168.39.100  255.255.255.0   192.168.39.1

Default Route      VLAN: "VLAN2301" / 2301
Native (untagged) VLAN: none

Xirrus_Wi-Fi_Array(config-vlan)# exit
Xirrus_Wi-Fi_Array(config)# ssid
Xirrus_Wi-Fi_Array(config-ssid)# add Companyx encryption none broadcast
Note: New SSID is created disabled. Enable after configuration.

Xirrus_Wi-Fi_Array(config-ssid)# edit Companyx
Xirrus_Wi-Fi_Array(config-ssid-Companyx)# vlan 2301
Xirrus_Wi-Fi_Array(config-ssid-Companyx)# enable
Xirrus_Wi-Fi_Array(config-ssid-Companyx)# show

SSID "Companyx" Settings
=====
State              Enabled
Active             Yes
Encryption         Global Open
VLAN Name          VLAN2301
VLAN Number        2301
QoS Level          2
Active Band        802.11a & 802.11g
Broadcast          On
DHCP Pool          none
Traffic Limit      Unlimited
Traffic/Station    Unlimited
Time on            Always
Time off           Never
Days on            All
Web Page Redirect  Disabled

Xirrus_Wi-Fi_Array(config-ssid-Companyx)# save
Xirrus_Wi-Fi_Array(config-ssid-Companyx)#
```



*Setting the default route enables the AP to send management traffic, such as Syslog messages and SNMP information to a destination behind a router.*

Figure 222. Configuring VLANs on an Open SSID

### Configuring Radio Assurance Mode (Loopback Tests)

The AP uses its built-in monitor radio to monitor other radios in the AP. Tests include sending probes on all channels and checking for a response, and checking whether beacons are received from the other radio. If a problem is detected, corrective actions are taken to recover. Loopback mode operation is described in detail in [“AP Monitor and Radio Assurance Capabilities”](#) on page 541.

The following actions may be configured:

- **alert-only**—the AP will issue an alert in the Syslog.
- **repair-without-reboot**—the AP will issue an alert and reset radios at the Physical Layer (Layer 1) and possibly at the MAC layer. The reset should not be noticed by users, and they will not need to reassociate.
- **reboot-allowed**—the AP will issue an alert, reset the radios, and schedule the AP to reboot at midnight (per local AP time) if necessary. All stations will need to reassociate to the AP.
- **off**—Disable IAP loopback tests (no self-monitoring occurs). Radio Assurance mode is off by default.

This is a global IAPs setting—the monitor radio will monitor all other radios according to the settings above, and it cannot be set up to monitor particular radios. Radio assurance mode requires Intrusion Detection to be set to Standard.

The following example shows you how to configure a loopback test.

```

192.168.39.125 - PuTTY

Xirrus-WiFi-Array# config
Xirrus-WiFi-Array(config)# interface iap
Xirrus-WiFi-Array(config-iap)# global_settings
Xirrus-WiFi-Array(config-iap-global)# intrude-detect standard
Interface IAP abg2 state changed to down
Interface IAP abg2 band changed to monitor
Interface IAP abg2 channel changed to monitor
Interface IAP abg2 antenna changed to internal omni
Interface IAP abg2 tx-power changed to 20
Interface IAP abg2 rx-threshold changed to -95
Interface IAP abg2 state changed to up

Xirrus-WiFi-Array(config-iap-global)# loopback-test
  alert-only          Enable IAP loopback tests with failure alerts only
  off                 Disable IAP loopback tests
  reboot-allowed      Enable IAP loopback tests with alerts & repairs & reboots if n
  repair-without-reboot Enable IAP loopback tests with alerts & repairs, but no reboot:
  <cr>                Set global IAP parameters

Xirrus-WiFi-Array(config-iap-global)# loopback-test repair-without-reboot
Xirrus-WiFi-Array(config-iap-global)#
Xirrus-WiFi-Array(config-iap-global)# show

Global IAP Settings Summary
-----
Country code          not set (defaults to US: United States)
Beacon interval       100 Kusec
Broadcast rates       standard
DTIM period           1 beacon
Short retries         7
Long retries          4
Total IAPs            16
Max stations/IAP      64
Max phones /IAP       16
Station timeout       1000 sec
Station reauth time   5 sec
Management            disallowed
Station to station    forward
Load balancing        off
Intrusion detection   standard
Auto chan power up    off
Auto chan schedule    none
Auto cell period      1200 sec
Auto cell overlap     5%
Xirrus Fast Roaming   via tunnels to arrays in-range or targeted
Sharp cell TX power   off
Public Safety Band    disabled
802.11h support       on
Loopback test mode    repair w/o reboot
LED activity           on when IAP up
                     blink on data frame transmitted
                     blink on data frame received
                     blink on management frame transmitted
                     blink on management frame received
                     blink heartbeat on station associated

Xirrus-WiFi-Array(config-iap-global)#
Do you want to save changes to flash [yes/no]: █

```

Figure 223. Configuring Radio Assurance Mode (Loopback Testing)



# Appendices

Page is intentionally blank

## Appendix A: Quick Reference Guide

This section contains product reference information. Use this section to locate the information you need quickly and efficiently. Topics include:

- “Factory Default Settings” on page 523.
- “Keyboard Shortcuts” on page 529.

### Factory Default Settings

The following tables show the Wireless AP’s factory default settings.

#### Host Name

Setting	Default Value
Host name	Serial Number (e.g., XR4012802207C)

#### Network Interfaces

##### Serial

Setting	Default Value
Baud Rate	115200
Word Size	8 bits
Stop Bits	1
Parity	No parity
Time Out	10 seconds

**Gigabit 1 and Gigabit 2**

Setting	Default Value
Enabled	Yes
DHCP	Yes
Default IP Address	10.0.2.1
Default IP Mask	255.255.255.0
Default Gateway	None
Auto Negotiate	On
Duplex	Full
Speed	1000 Mbps
MTU Size	1500
Management Enabled	Yes

**Server Settings****NTP**

Setting	Default Value
Enabled	No
Primary	time.nist.gov
Secondary	pool.ntp.org

**Syslog**

Setting	Default Value
Enabled	Yes



Setting	Default Value
Local Syslog Level	Information
Maximum Internal Records	500
Primary Server	None
Primary Syslog Level	Information
Secondary Server	None
Secondary Syslog Level	Information

### SNMP

Setting	Default Value
Enabled	Yes
Read-Only Community String (v2)	xirrus_read_only
Read-Write Community String (v2)	xirrus
Read-Only Community String (v3)	xirrus-ro
Read-Write Community String (v3)	xirrus-rw
Trap Host	null (no setting)
Trap Port	162
Authorization Fail Port	On

### DHCP

Setting	Default Value
Enabled	No
Maximum Lease Time	300 minutes
Default Lease Time	300 minutes

Setting	Default Value
IP Start Range	192.168.1.4
IP End Range	192.168.1.254
NAT	Disabled
IP Gateway	None
DNS Domain	None
DNS Server (1 to 3)	None

### Default SSID

Setting	Default Value
ID	<b>xirrus</b>
VLAN	None
Encryption	Off
Encryption Type	None
QoS	2
Enabled	Yes
Broadcast	On

### Security

#### Global Settings - Encryption

Setting	Default Value
Enabled	Yes
WEP Keys	null (all 4 keys)

Setting	Default Value
WEP Key Length	null (all 4 keys)
Default Key ID	1
WPA Enabled	No
TKIP Enabled	Yes
AES Enabled	Yes
EAP Enabled	Yes
PSK Enabled	No
Pass Phrase	null
Group Rekey	Disabled

**External RADIUS (Global)**

Setting	Default Value
Enabled	Yes
Primary Server	None
Primary Port	1812
Primary Secret	null (no secret)
Secondary Server	null (no IP address)
Secondary Port	1812
Secondary Secret	null (no secret)
Time Out (before primary server is retired)	600 seconds
Accounting	Disabled
Interval	300 seconds

Setting	Default Value
Primary Server	None
Primary Port	1813
Primary Secret	null (no secret)
Secondary Server	None
Secondary Port	1813
Secondary Secret	null (no secret)

### Internal RADIUS

Setting	Default Value
Enabled	No
The user database is cleared upon reset to the factory defaults. For the Internal RADIUS Server you have a maximum of 1,000 entries.	

### Administrator Account and Password

Setting	Default Value
ID	admin
Password	admin

### Management

Setting	Default Value
SSH	On
SSH timeout	300 seconds

Setting	Default Value
Telnet	Off
Telnet timeout	300 seconds
Serial	On
Serial timeout	300 seconds
Management over IAPs	Off
http timeout	300 seconds

### Keyboard Shortcuts

The following table shows the most common keyboard shortcuts used by the Command Line Interface.

Action	Shortcut
Cut selected data and place it on the clipboard.	<b>Ctrl + X</b>
Copy selected data to the clipboard.	<b>Ctrl + C</b>
Paste data from the clipboard into a document (at the insertion point).	<b>Ctrl + V</b>
Go to top of screen.	<b>Ctrl + Z</b>
Copy the active window to the clipboard.	<b>Alt + Print Screen</b>
Copy the entire desktop image to the clipboard.	<b>Print Screen</b>
Abort an action at any time.	<b>Esc</b>
Go back to the previous screen.	<b>b</b>
Access the Help screen.	<b>?</b>



## Appendix B: FAQ and Special Topics

This appendix provides valuable support information that can help you resolve technical difficulties. Before contacting Riverbed, review all topics below and try to determine if your problem resides with the Wireless AP or your network infrastructure. Topics include:

- [“General Hints and Tips” on page 531](#)
- [“Frequently Asked Questions” on page 532](#)
- [“ArrayOS Traps” on page 539](#)
- [“AP Monitor and Radio Assurance Capabilities” on page 541](#)
- [“RADIUS Vendor Specific Attribute \(VSA\) for Riverbed” on page 544](#)
- [“Location Service Data Formats” on page 545](#)
- [“Upgrading the AP Using the Boot Loader” on page 551](#)

### General Hints and Tips

This section provides some useful tips that will optimize the reliability and performance of your Wireless APs.

- The Wireless AP requires careful handling. For best performance, units should be mounted in a dust-free and temperature-controlled environment.
- If using multiple APs in the same area, maintain a distance of at least 100 feet (30m) between APs if there is direct line-of-sight between the units, or at least 50 feet (15 m) if a wall or other barrier exists between the units.
- Keep the Wireless AP away from electrical devices or appliances that generate RF noise. Because the AP is generally mounted on ceilings, be aware of its position relative to lighting (especially fluorescent lighting).
- If you are deploying multiple units, the AP should be oriented so that the monitor radio is oriented in the direction of the least required coverage, because when in monitor mode the radio does not function as an AP servicing stations.
- The Wireless AP should only be used with Wi-Fi certified client devices.

*See Also*

Multiple SSIDs

Security

VLAN Support

## Frequently Asked Questions

This section answers some of the most frequently asked questions, organized by functional area.

### Multiple SSIDs

**Q. What Are BSSIDs and SSIDs?**

**A.** BSSID (Basic Service Set Identifier) refers to an individual access point radio and its associated clients. The identifier is the MAC address of the access point radio that forms the BSS.

A group of BSSs can be formed to allow stations in one BSS to communicate to stations in another BSS by way of a backbone that interconnects each access point.

The Extended Service Set (ESS) refers to the group of BSSIDs that are grouped together to form one ESS. The ESSID (often referred to as SSID or “wireless network name”) identifies the Extended Service Set. Clients must associate to a single ESS at any given time. Clients ignore traffic from other Extended Service Sets that do not have the same SSID.

Legacy access points typically support one SSID per access point. Riverbed Wireless APs support the ability for multiple SSIDs to be defined and used simultaneously.

**Q. What would I use SSIDs for?**

**A.** The creation of different wireless network names allows system administrators to separate types of users with different requirements. The following policies can be tied to an SSID:

- Minimum security required to join this SSID.



- The wireless Quality of Service (QoS) desired for this SSID.
- The wired VLAN associated with this SSID.

As an example, one SSID named **accounting** might require the highest level of security, while another SSID named **guests** might have low security requirements.

Another example may define an SSID named **voice** that supports voice over Wireless LAN phones with the highest possible Quality of Service (QoS) definition. This type of SSID might also forward traffic to specific VLANs on the wired network.

### Q. How do I set up SSIDs?

- A. Use the following procedure as a guideline. For more detailed information, go to [“SSIDs” on page 274](#).
1. From the Web Management Interface, go to the [SSID Management](#) page.
  2. Select **Yes** to make the SSID visible to all clients on the network. Although the Wireless AP will not broadcast SSIDs that are hidden, clients can still associate to a hidden SSID if they know the SSID name to connect to it.
  3. Select the minimum security that will be required by users for this SSID.
  4. If desired (optional), select a Quality of Service (QoS) setting for this SSID. The QoS setting you define here will prioritize wireless traffic for this SSID over other SSID wireless traffic.
  5. If desired (optional), select a VLAN that you want this traffic to be forwarded to on the wired network.
  6. If desired (optional), you can select which radios this SSID will not be available on—the default is to make this SSID available on all radios.
  7. Click on the **Save** button  if you wish to make your changes permanent.

8. If you need to edit any of the SSID settings, you can do so from the [SSID Management](#) page.

*See Also*

[General Hints and Tips](#)

[Security](#)

[SSIDs](#)

[SSID Management](#)

[VLAN Support](#)

## Security

**Q. How do I ensure that I meet FIPS requirements?**

- A.** To meet the Level 2 security requirements of FIPS 140-2, follow the instructions in [“Implementing FIPS Security”](#) on page 609.

**Q. How do I configure the AP for PCI DSS auditing?**

- A.** A. To audit PCI DSS requirements, follow the instructions in [“Auditing PCI DSS”](#) on page 603.

**Q. How do I know my management session is secure?**

- A.** Follow these guidelines:
- Administrator passwords  
Always change the default administrator password (the default is **admin**), and choose a strong replacement password. When appropriate, issue **read only** administrator accounts.
  - SSH versus Telnet  
Be aware that Telnet is not secure over network connections and should be used only with a direct serial port connection. When connecting to the unit’s Command Line Interface over a network connection, you must use a Secure SHell (SSH) utility. The most commonly used freeware providing SSH tools is PuTTY. The AP only allows SSH-2 connections, so your SSH utility must be set up to use SSH-2.

- **Configuration auditing**  
Do not change approved configuration settings. The optional XMS offers powerful management features for small or large Wireless AP deployments, and can audit your configuration settings automatically. In addition, using the XMS eliminates the need for an FTP server.

**Q. Which wireless data encryption method should I use?**

- A.** Wireless data encryption prevents eavesdropping on data being transmitted or received over the airwaves. The Wireless AP allows you to establish the following data encryption configuration options:

- **Open**  
This option offers no data encryption and is **not recommended**, though you might choose this option if clients are required to use a VPN connection through a secure SSH utility, like PuTTY.
- **Wired Equivalent Privacy (WEP)**  
This option provides minimal protection (though much better than using an open network). An early standard for wireless data encryption and supported by all Wi-Fi certified equipment, WEP is vulnerable to hacking and is therefore not recommended for use by Enterprise networks.
- **Wi-Fi Protected Access (WPA)**  
This is a much stronger encryption model than WEP and uses TKIP (Temporal Key Integrity Protocol) with AES (Advanced Encryption Standard) to prevent WEP cracks.

TKIP solves security issues with WEP. It also allows you to establish encryption keys on a per-user-basis, with key rotation for added security. In addition, TKIP provides Message Integrity Check (MIC) functionality and prevents active attacks on the wireless network.

AES is the strongest encryption standard and is used by government agencies; however, old legacy hardware may not be capable of supporting the AES mode (it probably won't work on

older wireless clients). Because AES is the strongest encryption standard currently available, it is highly recommended for Enterprise networks.

Any of the above encryption modes can be used (and can be used at the same time).



*TKIP encryption does not support high throughput rates, per the IEEE 802.11n.*

**Q. Which user authentication method should I use?**

**A.** User authentication ensures that users are who they say they are. For example, the most obvious example of authentication is logging in with a user name and password. The Wireless AP allows you to choose between the following user authentication methods:

- Pre-Shared Key

Users must manually enter a key (pass phrase) on the client side of the wireless network that matches the key stored by the administrator in your Wireless APs.

- RADIUS 802.1x with EAP

802.1x uses a RADIUS server to authenticate large numbers of clients, and can handle different EAP (Extensible Authentication Protocol) authentication methods, including EAP-TLS, EAP-TTLS and EAP-PEAP. The RADIUS server can be internal (provided by the Wireless AP) or external. An external RADIUS server offers more functionality and is **recommended** for large Enterprise deployments.

When using this method, user names and passwords must be entered into the RADIUS server for user authentication.

- MAC Address ACLs (Access Control Lists)

MAC address ACLs provide a list of client adapter MAC addresses that are allowed or denied access to the wireless network. Access Control Lists work well when there are a limited

number of users—in this case, enter the MAC addresses of each user in the **Allow** list. In the event of a lost or stolen MAC adapter, enter the affected MAC address in the **Deny** list.

**Q. Why do I need to authenticate my Wireless AP units?**

**A.** When deploying multiple Wireless APs, you may need to define which units are part of which wireless network (for example, if you are establishing more than one network). In this case you need to employ the XMS, which can authenticate your APs automatically and ensure that only authorized units are associated with the defined wireless network.

**Q. What is rogue AP (Access Point) detection?**

**A.** The Wireless AP has integrated monitor capabilities, which can constantly scan the local wireless environment for rogue APs (non-Riverbed devices that are not part of your wireless network), unencrypted transmissions, and other security issues. Administrators can then classify each rogue AP and ensure that these devices do not interrupt or interfere with the network.

*See Also*

[General Hints and Tips](#)

[Multiple SSIDs](#)

[VLAN Support](#)

### VLAN Support

**Q. What Are VLANs?**

**A.** Virtual Local Area Networks (VLANs) are a logical grouping of network devices that share a common network broadcast domain. Members of a particular VLAN can be on any segment of the physical network but logically only members of a particular VLAN can see each other.

VLANs are defined and implemented using the wired network switches that are VLAN capable. Packets are tagged for transmission on a

particular VLAN according to the IEEE 802.1Q standard, with VLAN switches processing packets according to the tag.

**Q. What would I use VLANs for?**

- A.** Logically separating different types of users, systems, applications, or other logical division aids in performance and management of different network devices. Different VLANs can also be assigned with different packet priorities to prioritize packets from one VLAN over packets from another VLAN.

VLANs are managed by software settings—instead of physically plugging in and moving network cables and users—which helps to ease network management tasks.

**Q. What are Wireless VLANs?**

- A.** Wireless VLANs allow similar functionality to the wired VLAN definitions and extend the operation of wired VLANs to the wireless side of the network.

Wireless VLANs can be mapped to wireless SSIDs so that traffic from wired VLANs can be sent to wireless users of a particular SSID. The reverse is also true, where wireless traffic originating from a particular SSID can be tagged for transmission on a particular wired VLAN.

Sixteen SSIDs can be defined on your AP, allowing a total of sixteen VLANs to be accessed (one per SSID).

As an example, to provide guest user access an SSID of **guest** might be created. This SSID could be mapped to a wired VLAN that segregates unknown users from the rest of the wired network and restricts them to Internet access only. Wireless users could then associate to the wireless network via the **guest** SSID and obtain access to the Internet through the selected VLAN, but would be unable to access other privileged network resources.

*See Also*

[General Hints and Tips](#)

[Multiple SSIDs](#)

## ArrayOS Traps

AOS can generate the following traps which are intended to be handled using the Xirrus Management System.

Name	Description
<b>Admin Traps</b>	
adminLogin	Admin Logged into AP
adminLogout	Admin Logged out from AP
<b>Station Traps</b>	
stationACLFailure	Station rejected by ACL
stationRadiusAuthFailure	Station failed Radius server authentication
<b>General Traps</b>	
resetArray	Admin requested reset of the AP
rebootArray	Administrator requested a reboot of AP
softwareUploadFailure	AP software image upload failed
softwareUploadSuccess	AP software image upload succeeded
softwareUpgradeFailure	AP software upgrade failed
softwareUpgradeSuccess	AP software upgrade succeeded
dhcpRenewFailure	Unable to get DHCP Address
cfgChange	Configuration change
keepAlive	Keepalive notice
encDoorOpened	Enclosure door opened
encDoorClosed	Enclosure door closed
flashPartitionCorrupt	Flash partition corrupt
licenseUpdate	License updated
<b>Environmental Controller Traps</b>	
envCtrlTempOver	Outdoor enclosure temperature too high

Name	Description
envCtrlTempUnder	Outdoor enclosure temperature too low
envCtrlHumidOver	Outdoor enclosure humidity too high
envCtrlFanFail	Outdoor enclosure fan failure
<b>IAP (Radio) Traps</b>	
iapBeaconProbeFailure	No received beacons (or probe responses) from IAP, alert only
iapBeaconProbeFailurePhy Reset	No received beacons (or probe responses) from IAP, resetting interface PHY
iapBeaconProbeFailureMac Reset	No received beacons (or probe responses) from IAP, resetting interface MAC
iapBeaconProbeFailureArrayReboot	No received beacons (or probe responses) from IAP, scheduling AP reboot
<b>Trap Objects</b>	
cfgModuleOID	Configuration module OID (syntax object identifier)



## AP Monitor and Radio Assurance Capabilities

All models of the Wireless AP have integrated monitoring capabilities to check that the AP's radios are functioning correctly, and act as a threat sensor to detect and prevent intrusion from rogue access points.



*We recommend using **iap1** for monitoring on AP models with up to four radios, as this radio assignment results in the best overall traffic throughput for the AP. See “IAP Settings” on page 319.*

### Enabling Monitoring on the AP

Any radio may be set to monitor the AP or to be a normal radio. In order to enable the functions required for intrusion detection and for monitoring the other AP radios, you **must** configure one monitor radio on the IAP Settings window as follows:

- Check the **Enabled** checkbox.
- Set **Mode** to **Monitor**.
- Set **Channel** to **Monitor**.

The settings above will automatically set the **Antenna** selection to **Internal-Omni.**, also required for monitoring. See the “IAP Settings” on page 319 for more details. The values above are the factory default settings for the AP.

You must also enable **RF Monitor Mode** on the AP (either **Timeshare** or **Dedicated**). See “Advanced RF Settings” on page 364.

### How Monitoring Works

When the monitor radio has been configured as just described, it performs these steps continuously (24/7) to check the other radios on the AP and detect possible intrusions:

1. The monitor radio scans all channels with a 200ms dwell time, hitting all channels about once every 10 seconds.
2. Each time it tunes to a new channel it sends out a probe request in an attempt to smoke out rogues.

3. It then listens for all probe responses and beacons to detect any rogues within earshot.
4. AP radios respond to that probe request with a probe response.

**Intrusion Detection** is enabled or disabled separately from monitoring. See [Step 1](#) in [“Intrusion Detection”](#) on page 378.

### Radio Assurance

The AP is capable of performing continuous, comprehensive tests on its radios to assure that they are operating properly. Testing is enabled using the **Radio Assurance Mode** setting (see [“Advanced RF Settings”](#) on page 364). When this mode is enabled, the monitor radio performs loopback tests on the AP. Radio Assurance Mode requires **Intrusion Detection** to be set to **Standard** (See [Step 1](#) in [“Intrusion Detection”](#) on page 378).

When **Radio Assurance Mode** is enabled:

1. The AP keeps track of whether or not it hears beacons and probe responses from the AP’s radios.
2. After 10 minutes (roughly 60 passes on a particular channel by the monitor radio), if it has not heard beacons or probe responses from one of the AP’s radios it issues an alert in the Syslog. If repair is allowed (see [“Radio Assurance Options”](#) on page 543), the AP will reset and reprogram that particular radio at the Physical Layer (PHY—Layer 1). This action takes under 100ms and stations are not deauthenticated, thus users should not be impacted.
3. After another 10 minutes (roughly another 60 passes), if the monitor still has not heard beacons or probe responses from the malfunctioning radio it will again issue an alert in the Syslog. If repair is allowed, the AP will reset and reprogram the MAC (the lower sublayer of the Data Link Layer) and then all of the PHYs. This is a global action that affects all radios. This action takes roughly 300ms and stations are not deauthenticated, thus users should not be impacted.
4. After another 10 minutes, if the monitor still has not heard beacons or probe responses from that radio, it will again syslog the issue. If reboot is

allowed (see “[Radio Assurance Options](#)” on page 543), the AP will schedule a reboot. This reboot will occur at one of the following times, whichever occurs first:

- When no stations are associated to the AP
- Midnight

### Radio Assurance Options

If the monitor detects a problem with an AP radio as described above, it will take action according to the preference that you have specified in the **Radio Assurance Mode** setting on the [Advanced RF Settings](#) window (see [Step 2](#)):

- **Failure alerts only**—The AP will issue alerts in the Syslog, but will not initiate repairs or reboots.
- **Failure alerts & repairs, but no reboots**—The AP will issue alerts and perform resets of the PHY and MAC as described above.
- **Failure alerts & repairs & reboots if needed**—The AP will issue alerts, perform resets of the PHY and MAC, and schedule reboots as described above.
- **Disabled**—Disable loopback tests (no self-monitoring occurs). Loopback tests are disabled by default.

---

## RADIUS Vendor Specific Attribute (VSA) for Riverbed

A RADIUS VSA is defined for Riverbed APs to control administrator privilege settings for user accounts. The RADIUS VSA is used by APs to define the following attribute for administrator accounts:

- **AP administrators**—the **Riverbed-Admin-Role** attribute sets the privilege level for this account. Set the value to the string defined in **Privilege Level Name** as described in [“About Creating Admin Accounts on the RADIUS Server”](#) on page 240.

Note that the VSA key (VENDOR value) for Xirrus is 21013:1.

dm	Device Mfg
dt	Device Type
dc	Device Class
px	Coordinate x
py	Coordinate y
pz	Coordinate z

## Location Service Data Formats

Riverbed APs are able to capture and upload visitor analytics data, acting as a sensor network in addition to providing wireless connectivity. This data is sent to the location server in different formats, based on the type of server. The **Location Server URL**, **Location Customer Key**, and **Location Period** for reporting data are configured under Location settings. See “[Location](#)” on page 195 and “[location-reporting](#)” on page 481 for details. If a **Location Customer Key** has been entered, data is sent encrypted using AES with that key.

### Euclid Location Server

If the **Location Server URL** contains the string **euclid**, then it specifies a Euclid server. Data is sent at the specified intervals, in the proprietary format expected by the Euclid location server.

### Non-Euclid Location Server

If the **Location Server URL** doesn’t contain the string “euclid”, then data is sent as a JSON object at the specified intervals, with the fields described in the table below.

### Data Format Table

Location service data formats are described in the table below. The **Use** field indicates whether a data item is included for a particular location server type:

- **E** indicates that this data is *only* sent for a Euclid location server.
- **N** indicates that this data is *only* sent for a non-Euclid location server.
- **X** indicates that this data is *only* sent if the string **xirrus** is found in the URL.
- **-X** indicates that this data is *not* sent if the string **xirrus** is found in the URL. The AP assumes that you are using location based services for stations, and reduces the size of messages by dropping unneeded fields from the output.

See the footnotes at the end of the table for more information.

Field	Name	Use	Description
vs		E	Euclid header fixed value (3)
pf		E	Euclid header fixed value (11)
sn	MAC Address	E	Euclid header - AP MAC Address
sq	Message Count	E	Euclid header - Message Count
lh	Host Name	N	Header - AP host name
ln	Location Name	N	Header - AP location string
ld	Location Data	N	Defined below
vn	Version No.	N	Set to 1
ti	Time	N	Time of message
ma	MAC Address	N	Base IAP MAC Address
mc	Message Count	N	Running message count (resets to 0 when AP is rebooted)
ax	PositionX	X	These location coordinates are sent to the AP by XMS-Enterprise. They appear only if the AP has been placed on an XMS map. *
ay	PositionY	X	
az	PositionZ	X	
sc	PositionScale	X	
ro	PositionAngle	X	
fu	PositionMount	X	
gb	PositionGlobal	X	
mp	MapName	X	
la	GpsLatitude	X	
lo	GpsLongitude	X	
el	GpsElevation	X	
ra	GpsReference	X	

Field	Name	Use	Description
lt	Location Table		Table of Stations and APs heard during this window
si	Station ID		Station MAC address (for encryption, see <a href="#">"location-reporting" on page 481</a> )
bi	BSSID		BSSID that the station is on (AES encrypted if cust-key is not blank). Only stations that are associated to this AP will have a bi (BSSID) field, i.e., for unassociated stations the bi (BSSID) field will not be included.
sm	Station OUI		OUI of Station manufacturer (the top 3 bytes of the MAC address that can be used to look up the manufacturer), unencrypted ***
ap	AP Flag		1=AP, 0=Station ***
as	Assoc		1= Station is associated to AP***
dm	Device Mfg	N	Station manufacturer
dt	Device Type	N	Type of device, such as iPhone or Android ***
dc	Device Class	N	Category of device, such as phone or notebook ***
px	Coordinate x	N	These location coordinates are sent to the AP by XMS. They appear only if the AP has been placed on a map in XMS. *
py	Coordinate y	N	
pz	Coordinate z	N	
pn	Number	N	Number of APs involved in the location calculation
po	Old	N	0 = New Multi-AP calculation used 1 = Old single AP multi-radio calculation
pt	Time	N	Time stamp for latest data used in location calculation
cn	Count	-X	Count of frames heard from device during this window ***
ot	Origin Time	-X	Timestamp of first frame in this window (Unix time in seconds) ***

Field	Name	Use	Description
ct	Current Time	-X	Timestamp of last frame in this window (Unix time in seconds) ***
cf	Current Frequency	-X	Frequency (MHz) last frame was heard on ***
is	Sum	E	Sum of values for receive interval
i2	Sum of Squares	E	Sum of squares of values for receive interval
i3	Sum of Cubes	E	Sum of cubes of values for receive interval
il	Interval Low	-X	Minimum interval between frames (within 24 hr period) ***
ih	Interval High	-X	Maximum interval between frames (within 24 hr period) ***
ss	Sum	E	Sum of values for signal strength
s2	Sum of Squares	E	Sum of squares of values for signal strength
s3	Sum of Cubes	E	Sum of cubes of values for signal strength
sl	Signal Low	-X	Minimum signal strength (within 24 hr period) ***
sh	Signal High	-X	Maximum signal strength (within 24 hr period) ***
so	Signal Origin	-X	Signal strength of first frame heard ***
sc	Signal Current		Signal strength of last frame heard
am		X	List of AP MAC addresses used in location calculation
ar		X	List of AP RSSIs used in location calculation
ab		X	List of AP bias values used in location calculation
at		X	List of AP time stamps used in location calculation





eliminates duplicate data being sent. Note that if a station's RSSI is the same at two or more APs, then they will all send data, so there is a chance of seeing duplicates.

## Upgrading the AP Using the Boot Loader



*This procedure does not apply to Boot Loader versions 7000 or higher (these recent versions are supplied with ArrayOS 7.3 and above). See “Access Point Information” on page 106 to view the Boot Loader version on the AP.*

If you are experiencing difficulties communicating with the AP using the Web Management Interface, the AP provides lower-level facilities that may be used to accomplish an upgrade via the Boot Loader (XBL).

1. Log in to your Riverbed customer support account and download the latest software update. The software update is provided as a zip file. Unzip the contents to a local temp directory. Take note of the extracted file name in case you need it later on—you may also need to copy this file elsewhere on the network depending on your situation.
2. Install a TFTP server software package if you don't have one running. It may be installed on any computer on your network, including your desktop or laptop. The Solar Winds version is freeware and works well.

<http://www.solarwinds.com>

The TFTP install process creates the **TFTP-Root** directory on your C: drive, which is the default target for sending and receiving files. This may be changed if desired. Place the extracted Riverbed software update file(s) on this directory.

You must make the following change to the default configuration of the Solar Winds TFTP server. In the **File** menu, select **Configure**, then select the **Security** tab. Click **Send files** and click **OK**.

3. Determine the IP address of the computer hosting the TFTP server. (To display the IP address, open a command prompt and type **ipconfig**)
4. Connect your AP to the computer running TFTP: a) if the AP has a Console port, connect a serial cable to it and open a terminal program; or b) use Xircon to communicate with the AP. [Download Xircon and see the](#)

[User's Guide here](#). You may also find this useful: [How can I access my AP if it does not seem to be accessible via IP? How do I access an AP via console or Xircon?](#)

Attach a network cable to the AP's Gig1 port, if it is not already part of your network. Boot your AP and watch the progress messages. When **Press space bar to exit to bootloader:** is displayed, press the space bar. The rest of this procedure is performed using the bootloader.

The following steps assume that you are running DHCP on your local network.

5. Type **dhcp** and hit return. This instructs the AP to obtain a DHCP address and use it during this boot in the bootloader environment.
6. Type **dir** and hit return to see what's currently in the compact flash.
7. Type **update server <TFTP-server-ip-addr> XS-7.x.x-xxxx.bin** (the actual file name will vary depending on AP model and software version—use the file name from your software update) and hit return. The software update will be transferred to the AP's memory and will be written to the compact flash card. (See output below.)
8. Type **dir** and hit return to verify that the new image is in the compact flash.
9. Type **env set bootfile\_active XS-7.x.x-xxxx.bin** (the actual file name of the new image) and hit return. This sets the new image to be the current image—the image to load when the AP reboots.
10. Type **env save** and hit return to save the change you just made.
11. Type **boot** and hit return. Your AP will reboot, running your new version of software.

### Sample Output for the Upgrade Procedure:

The user actions are highlighted in the output below, for clarity. Output will be in the form shown below, but may not be exactly the same.

```
Username: admin
Password: ****
```

```
XR50326004F89# configure
XR50326004F89(config)# reboot
Are you sure you want to reboot? [yes/no]: yes
```

```
Array is being rebooted...
Sending trap .... done
Rebooting ...
```

```
Xirrus Boot Loader 6.3.0-6171 (Dec 11 2014 - 15:41:48)
```

```
Board      | Xirrus CN5020-CP CPU Board
Clocks     | CPU : 300 MHz  DDR : 666 MHz
I2C Bus    | 384 KHz, sampling at 11 MHz
Reset      | Reset requested
Watchdog   | Enabled (5 secs)
System DDR | 512 MB, DDR2 Unbuffered non-ECC
FLASH      | 2 MB, CRC: OK
RTC        | Fri 2014-Dec-12 19:40:11 GMT
CPU BIST   | pass
PCI        | PCI 32-bit, BAR 0: 0x08000000
Radios     | 0 1
Network    | eth0
USB        | 1 Storage Device found
Environment | Initialized
```

```
In: ser_xc
Out: ser_xc
Err: ser_xc
```

```
Press space bar to exit to bootloader: 0
```

Username: **admin**

Password: **\*\*\*\***

XBL>**dhcp**

[DHCP ] Device : eth0 - 1000 Mbps Full Duplex

[DHCP ] IP Addr : 10.100.44.48

XBL>**dir**

[USB 0 ] Directory of /

Date	Time	Size	File or Directory name
2014-Dec-12	18:47:16	17776	factory.conf
2014-Dec-12	19:39:42	17810	lastboot.conf
2014-Dec-12	19:37:56	17810	saved.conf
2014-Dec-11	23:57:16		ssl/
2014-Dec-11	23:57:16		wmi/
2014-Dec-12	19:35:18		history/
2014-Dec-12	18:49:12		storage/
2014-Dec-12	18:46:28		wpr/
2014-Dec-12	19:39:20		tmp/
2014-Dec-12	18:41:28	77993740	XS-7.1.2-5152.bin
2014-Dec-12	19:38:14	29	lastboot.old
2014-Dec-12	19:38:58	29	lastboot
2014-Dec-12	18:47:26		proxy-client/

6 file(s), 7 dir(s)

XBL>**update server 10.100.44.44 XS-7.2.3-5452.bin**

[TFTP ] Device : eth0 - 1000 Mbps Full Duplex

[TFTP ] Client : 10.100.44.48

[TFTP ] Server : 10.100.44.44

[TFTP ] File : XS-7.2.3-5452.bin

[TFTP ] Address : 0x6000000

[TFTP ] Loading : #####

```
[TFTP ] Loading : ##### done
[TFTP ] Complete: 7.4 sec, 10.1 MB/sec
[TFTP ] Bytes : 78027656 (4a69b88 hex), 10226 Kbytes/sec
[USB 0 ] File : XS-7.2.3-5452.bin
[USB 0 ] Address : 0x6000000
[USB 0 ] Saving : #####
[USB 0 ] Saving : #####
[USB 0 ] Saving : #####
[USB 0 ] Saving : #####
[USB 0 ] Saving : #####
[USB 0 ] Saving : ##### done
[USB 0 ] Complete: 59.5 sec, 1.3 MB/sec
[USB 0 ] Bytes : 78027656 (4a69b88 hex)
XBL>dir
```

```
[USB 0 ] Directory of /
  Date   Time   Size  File or Directory name
-----
2014-Dec-12 18:47:16  17776  factory.conf
2014-Dec-12 19:39:42  17810  lastboot.conf
2014-Dec-12 19:37:56  17810  saved.conf
2014-Dec-11 23:57:16          ssl/
2014-Dec-11 23:57:16          wmi/
2014-Dec-12 19:35:18          history/
2014-Dec-12 18:49:12          storage/
2014-Dec-12 18:46:28          wpr/
2014-Dec-12 19:39:20          tmp/
2014-Dec-12 18:41:28 77993740 XS-7.1.2-5152.bin
2014-Dec-12 19:38:14   29  lastboot.old
2014-Dec-12 19:38:58   29  lastboot
2014-Dec-12 18:47:26          proxy-client/
2014-Dec-12 19:41:22 78027656 XS-7.2.3-5452.bin
```

7 file(s), 7 dir(s)

```
XBL>env set bootfile_active XS-7.2.3-5452.bin
XBL>env save
```

```
[Flash ] Saving : Environment 4 KB
XBL>boot
[USB 0 ] File   : XS-7.2.3-5452.bin
[USB 0 ] Address : 0x6000000
[USB 0 ] Loading : #####
[USB 0 ] Loading : ##### done
[USB 0 ] Complete: 6.5 sec, 11.4 MB/sec
[USB 0 ] Bytes   : 78027656 (4a69b88 hex)
[Boot  ] Address : 0x06000000
[Image ] Name    : XR-7.2.3-5452
[Image ] Created : 2014-11-13 7:52:39 UTC
[Image ] Type    : MIPS Linux Multi-File Image (uncompressed)
[Image ] Size    : 78027552 Bytes = 74.4 MB
[Image ] Contents: File 0: 17248885 Bytes = 16.4 MB
[Image ] Contents: File 1: 49149529 Bytes = 46.9 MB
[Image ] Contents: File 2: 11629116 Bytes = 11.1 MB
[Boot  ] Image   : Verifying image ..... OK
[Boot  ] Loading : Multi-File Image .... OK
[Boot  ] Watchdog: Disabling .... OK
[Boot  ] Execute : Transferring control to OS
```

Initializing hardware ..... OK

Xirrus Wi-Fi Array  
ArrayOS Version 7.2.3-5452  
Copyright (c) 2005-2014 Xirrus, Inc.  
<http://www.xirrus.com>

Username:



## Appendix C: Notices (XA, XD and XR500/600 Series Only)



*This Appendix contains Notices, Warnings, and Compliance information for the XA, XD and XR500/600 Series only.*

*For Notices, Warnings, and Compliance information for outdoor products, please see the Quick Installation Guide for that product.*

*For Notices, Warnings, and Compliance information for XR-320 and X2-120, please see the X2 and XR300 Series Notices and Regulatory Guide.*

*For Notices, Warnings, and Compliance information for all other APs, please see “Notices (XR-1000 to XR-6000 Indoor Models)” on page 577.*

This appendix contains the following information:

- “Notices” on page 557
- “EU Compliance Information” on page 565
- “Compliance Information (Non-EU)” on page 572
- “Safety Warnings” on page 574
- “Translated Safety Warnings” on page 575
- “Software and Hardware License and Warranty Agreement” on page 576
- “For Software License and Product Warranty information, please see <https://www.riverbed.com/legal/license.html>.” on page 576

### Notices

#### Wi-Fi Alliance Certification



[www.wi-fi.org](http://www.wi-fi.org)

### **FCC Notice for XD4-240 (XD4240)**

This equipment has been tested and found to comply with the limits for a Class A digital device, pursuant to part 15 of the FCC Rules. These limits are designed to provide reasonable protection against harmful interference when the equipment is operated in a commercial environment. This equipment generates, uses, and can radiate radio frequency energy and, if not installed and used in accordance with the instruction manual, may cause harmful interference to radio communications. Operation of this equipment in a residential area is likely to cause harmful interference in which case the user will be required to correct the interference at his own expense.

### **FCC Notice for All Other Devices Covered by This Appendix**

This equipment has been tested and found to comply with the limits for a Class B digital device, pursuant to Part 15 of the FCC rules. These limits are designed to provide reasonable protection against harmful interference in a residential installation. This equipment generates, uses and can radiate RF energy and, if not installed and used in accordance with the instructions, may cause harmful interference to radio communications. However, there is no guarantee that interference will not occur in a particular installation. If this equipment does cause harmful interference to radio or television reception, which can be determined by turning the equipment off and on, the user is encouraged to try to correct the interference by one or more of the following safety measures:

- Reorient or relocate the receiving antenna.
- Increase the separation between the equipment and the receiver.
- Connect the equipment into an outlet on a circuit different from that to which the receiver is connected.
- Consult the dealer or an experienced wireless technician for help.

### **For All Devices Covered by This Appendix**

The rest of the information in this Appendix applies to all Riverbed Xirrus XA, XD and XR500/600 Series APs, except as noted.

**!** *FCC Caution: Any changes or modifications not expressly approved by the party responsible for compliance could void the user's authority to operate this equipment.*

This device complies with Part 15 of the FCC Rules, with operation subject to the following two conditions: (1) This device may not cause harmful interference, and (2) this device must accept any interference received, including interference that may cause unwanted operation.

For all models available in the USA/Canada market, only channels 1~11 can be operated in the 2.4GHz band. Selection of other channels is not possible.

This device and its antenna(s) must not be co-located or operating in conjunction with any other antenna or transmitter except in accordance with FCC multi-transmitter product procedures.

This device is restricted for indoor use.

Operations in the 5.15-5.25GHz band are restricted to indoor usage only.

### **IMPORTANT NOTE: FCC Radiation Exposure Statement**

This equipment complies with FCC radiation exposure limits set forth for an uncontrolled environment. To ensure compliance with FCC and Industry Canada RF exposure requirements, this device must be installed in a location where the antennas of the device will have a minimum distance of at least 30 cm (12 inches) from all persons, except that XD2 models must have a minimum distance of at least 21 cm (8.3 inches) from all persons, and the antennas of XA4 models must have a minimum distance of at least 34 cm (13.6 inches) from all persons. Using higher gain antennas and types of antennas not certified for use with this product is not allowed. The device shall not be co-located with another transmitter.

### **High Power Radars**

High power radars are allocated as primary users (meaning they have priority) in the 5250MHz to 5350MHz and 5650MHz to 5850MHz bands. These radars could cause interference and/or damage to LE-LAN devices.

### **Non-Modification Statement**

Unauthorized changes or modifications to the device are not permitted. Use only the supplied internal antenna, or external antennas supplied by the manufacturer. Modifications to the device will void the warranty and may violate FCC regulations.

### **Cable Runs for Power over Ethernet (PoE)**

The AP must be connected to PoE networks without routing cabling to the outside plant—this ensures that cabling is not exposed to lightning strikes or possible cross over from high voltage.

### **Battery Warning**

- ! *Caution! The AP contains a battery which is not to be replaced by the customer. Danger of Explosion exists if the battery is incorrectly replaced. Replace only with the same or equivalent type recommended by the manufacturer. Dispose of used batteries according to the manufacturer's instructions.*

### **UL Statement**

Power over Ethernet must be supplied by a UL listed I.T.E. product.

### **Industry Canada Statement (XA, XD Series)**

This device complies with Industry Canada license-exempt RSS standards (RSS 247), and standards for Digital Transmission Systems (DTSS), Frequency Hopping Systems (FHSs) and License-Exempt Local Area Network (LE-LAN) Devices. Operation is subject to the following two conditions: (1) this device may not cause interference, and (2) this device must accept any interference, including interference that may cause undesired operation of the device.

*Le présent appareil est conforme aux CNR d'Industrie Canada applicables aux appareils radio exempts de licence. L'exploitation est autorisée aux deux conditions suivantes: (1) l'appareil ne doit pas produire de brouillage, et (2) l'utilisateur de l'appareil doit accepter tout brouillage radioélectrique subi, même si le brouillage est susceptible d'en compromettre le fonctionnement.*

For product available in the USA/Canada market, only channel 1~11 can be operated. Selection of other channels is not possible.

*Pour les produits disponibles aux États-Unis / Canada du marché, seul le canal 1 à 11 peuvent être exploités. Sélection d'autres canaux n'est pas possible.*

This device and its antenna(s) must not be co-located or operating in conjunction with any other antenna or transmitter except in accordance with IC multi-transmitter product procedures.

*Cet appareil et son antenne (s) ne doit pas être co-localisés ou fonctionnement en association avec une autre antenne ou transmetteur.*

Dynamic Frequency Selection (DFS) for devices operating in the bands 5250- 5350 MHz, 5470-5600 MHz and 5650-5725 MHz

*Sélection dynamique de fréquences (DFS) pour les dispositifs fonctionnant dans les bandes 5250-5350 MHz, 5470-5600 MHz et 5650-5725 MHz*

The device for operation in the band 5150-5250 MHz is only for indoor use to reduce the potential for harmful interference to co-channel mobile satellite systems.

*Les dispositifs fonctionnant dans la bande 5150-5250 MHz sont réservés uniquement pour une utilisation à l'intérieur afin de réduire les risques de brouillage préjudiciable aux systèmes de satellites mobiles utilisant les mêmes canaux.*

For indoor use only.

*Pour une utilisation en intérieur uniquement.*

### **IMPORTANT NOTES (XA, XD Series):**

#### **IC Radiation Exposure Statement:**

To ensure compliance with Industry Canada RF exposure requirements, this device must be installed in a location where the antennas of XD Series devices will have a minimum distance of at least 30 cm (12 inches) from all persons; for XA4 models the minimum distance from antennas is 34 cm (13.6 inches). Using higher gain antennas and types of antennas not certified for use with this product is not allowed. The device shall not be co-located with another transmitter.

*Installez l'appareil en veillant à conserver une distance d'au moins 30 cm (pour XA4: 34 cm) entre les éléments rayonnants et les personnes. Cet avertissement de sécurité est conforme aux limites d'exposition définies par la norme CNR-102 at relative aux fréquences radio.*

**External Antennas (for XA4 only)**

This radio transmitter (IC: 5428A - XDR240, IC: 5428A - XDR241) has been approved by Industry Canada to operate with the antenna types listed below with the maximum permissible gain indicated. Antenna types not included in this list, having a gain greater than the maximum gain indicated for that type, are strictly prohibited for use with this device.

*Le présent émetteur radio (IC: 5428A - XDR240, IC: 5428A - XDR241) a été approuvé par Industrie Canada pour fonctionner avec les types d'antenne énumérés ci-dessous et ayant un gain admissible maximal d'antenne. Les types d'antenne non inclus dans cette liste, ou dont le gain est supérieur au gain maximal indiqué, sont strictement interdits pour l'exploitation de l'émetteur.*

IC: 5428A - XDR240

Ant.	Brand	Model Name (P/N)	Antenna Type	Connector	Gain (dBi)	
					2.4GHz	5GHz
1	WNC	EW2458-02	Dipole Antenna	Reversed-SMA	2	3
2	Laird	PDQ24499	Directional Antenna	Reversed-SMA	8.6	9.4

IC: 5428A - XDR241

Ant.	Brand	Model Name (P/N)	Antenna Type	Connector	Gain (dBi)
					5GHz
1	WNC	EW2458-02	Dipole Antenna	Reversed-SMA	3
2	Laird	PDQ24499	Directional Antenna	Reversed-SMA	9.4

The maximum antenna gain permitted for devices in the bands 5250-5350 MHz and 5470-5725 MHz shall be such that the equipment still complies with the e.i.r.p. limit.

*Le gain maximal d'antenne permis pour les dispositifs utilisant les bandes 5250-5350 MHz et 5470-5725 doit se conformer à la limite de p.i.r.e.*

The maximum antenna gain permitted for devices in the band 5725-5850 MHz shall be such that the equipment still complies with the e.i.r.p. limits specified for point-to-point and non-point-to-point operation as appropriate.

*Le gain maximal d'antenne permis (pour les dispositifs utilisant la bande 5725-5850 MHz) doit se conformer à la limite de p.i.r.e. spécifiée pour l'exploitation point à point et non point à point, selon le cas.*

### **Industry Canada Statement (except for XA4 and XD Series)**

This device complies with RSS-210 of the Industry Canada Rules. Operation is subject to the following two conditions: (1) This device may not cause harmful interference, and (2) this device must accept any interference received, including interference that may cause undesired operation.

*Ce dispositif est conforme à la norme CNR-210 d'Industrie Canada applicable aux appareils radio exempts de licence. Son fonctionnement est sujet aux deux conditions suivantes: (1) le dispositif ne doit pas produire de brouillage préjudiciable, et (2) ce dispositif doit accepter tout brouillage reçu, y compris un brouillage susceptible de provoquer un fonctionnement indésirable.*

### **Caution:**

(i) the device for operation in the band 5150-5250 MHz is only for indoor use to reduce the potential for harmful interference to co-channel mobile satellite systems;

(ii) high-power radars are allocated as primary users (i.e. priority users) of the bands 5250-5350 MHz and 5650-5850 MHz and that these radars could cause interference and/or damage to LE-LAN devices.

When operating the XR-600 Series in the band 5250-5350 MHz with a maximum e.i.r.p. greater than 200 mW in Canada, please adjust antenna/EUT to comply with the following e.i.r.p. elevation mask, where  $\theta$  is the angle above the local

horizontal plane (of the Earth) as shown below:

- (i) -13 dB(W/MHz) for  $0^\circ \leq \theta < 8^\circ$
- (ii) -13 - 0.716 ( $\theta$ -8) dB(W/MHz) for  $8^\circ \leq \theta < 40^\circ$
- (iii) -35.9 - 1.22 ( $\theta$ -40) dB(W/MHz) for  $40^\circ \leq \theta \leq 45^\circ$
- (iv) -42 dB(W/MHz) for  $\theta > 45^\circ$

***Avertissement:***

*(i) les dispositifs fonctionnant dans la bande 5 150-5 250 MHz sont réservés uniquement pour une utilisation à l'intérieur afin de réduire les risques de brouillage préjudiciable aux systèmes de satellites mobiles utilisant les mêmes canaux;*

*(ii) De plus, les utilisateurs devraient aussi être avisés que les utilisateurs de radars de haute puissance sont désignés utilisateurs principaux (c.-à-d., qu'ils ont la priorité) pour les bandes 5 250-5 350 MHz et 5 650-5 850 MHz et que ces radars pourraient causer du brouillage et/ou des dommages aux dispositifs LAN-EL.*

**IMPORTANT NOTE (Series other than XA and XD):**

**IC Radiation Exposure Statement:**

To ensure compliance with Industry Canada RF exposure requirements, this device must be installed in a location where the antennas of the device will have a minimum distance of at least 30 cm (12 inches) from all persons. Using higher gain antennas and types of antennas not certified for use with this product is not allowed. The device shall not be co-located with another transmitter.

*Installez l'appareil en veillant à conserver une distance d'au moins 30 cm entre les éléments rayonnants et les personnes. Cet avertissement de sécurité est conforme aux limites d'exposition définies par la norme CNR-102 at relative aux fréquences radio.*



## EU Compliance Information



*This section applies to the XA, XD and XR600 Series only. For other models, see the notes at the beginning of this appendix.*

### **Radio Equipment Directive (RED) 2014/53/EU Compliance Information**

Frequencies from 5150 to 5350 (5 GHz channels 36-64) are restricted to indoor use only.



AT	BE	BG	CH	CY	CZ	DE	DK	EE	EL	ES
FI	FR	HR	HU	IE	IS	IT	LI	LT	LU	LV
MT	NL	NO	PL	PT	RO	SE	SI	SK	TR	UK

This section contains compliance information for the Riverbed Xirrus Wireless AP family of products. The compliance information contained in this section is relevant to the European Union and other countries that have implemented the EU Directive 2014/53/EC.

Riverbed, Inc. declares that these radio equipment types [XR600, XR2000 and XR4000 Series APs; XD2240, XD4130, XD4240, and XA4240 APs; and XIAC867, XIAC1300, and XIAC3470 radio modules] are in compliance with Directive 2014/53/EU. The full text of the EU declaration of conformity is available at the following internet address: [www.xirrus.com/declarations-of-conformity/](http://www.xirrus.com/declarations-of-conformity/).

### **Declaration of Conformity**

#### **Cesky [Czech]**

Toto zařízení je v souladu se základními požadavky a ostatními odpovídajícími ustanoveními Směrnice 2014/53/EC.

#### **Dansk [Danish]**

Dette udstyr er i overensstemmelse med de væsentlige krav og andre relevante bestemmelser i Direktiv 2014/53/EF.

<b>Deutsch [German]</b>	Dieses Gerat entspricht den grundlegenden Anforderungen und den weiteren entsprechenden Vorgaben der Richtlinie 2014/53/EU.
<b>Eesti [Estonian]</b>	See seande vastab direktiivi 2014/53/EU olulistele nõuetele ja teistele asjakohastele sätetele.
<b>English</b>	This equipment is in compliance with the essential requirements and other relevant provisions of Directive 2014/53/EC.
<b>Español [Spain]</b>	Este equipo cump le con los requisitos esenciales asi como con otras disposiciones de la Directiva 2014/53/CE.
<b>Ελληνική [Greek]</b>	Αυτός ο εξοπλισμός είναι σε συμμόρφωση με τις ουσιώδεις απαιτήσεις και ύλλες σχετικές διατάξεις της Οδηγίας 2014/53/EC.
<b>Français [French]</b>	Cet appareil est conforme aux exigences essentielles et aux autres dispositions pertinentes de la Directive 2014/53/EC.
<b>Íslenska [Icelandic]</b>	Þetta tæki er samkvæmt grunnkröfum og öðrum viðeigandi ákvæðum Tilskipunar 2014/53/EC.
<b>Italiano [Italian]</b>	Questo apparato é conforme ai requisiti essenziali ed agli altri principi sanciti dalla Direttiva 2014/53/CE.
<b>Latviski [Latvian]</b>	Šī iekārta atbilst Direktīvas 2014/53/EK būtiskajā prasībām un citiem ar to saistītajiem noteikumiem.
<b>Lietuvių [Lithuanian]</b>	Šis įrenginys tenkina 2014/53/EB Direktyvos esminius reikalavimus ir kitas šios direktyvos nuostatas.
<b>Nederlands [Dutch]</b>	Dit apparant voldoet aan de essentiële eisen en andere van toepassing zijnde bepalingen van de Richtlijn 2014/53/EC.
<b>Malti [Maltese]</b>	Dan l-apparant huwa konformi mal-htigiet essenzjali u l-provedimenti l-oħra rilevanti tad-Direttiva 2014/53/EC.

<b>Magyar [Hungarian]</b>	Ez a készülék teljesíti az alapvető követelményeket és más 2014/53/EK irányelvben meghatározott vonatkozó rendelkezéseket.
<b>Norsk [Norwegian]</b>	Dette utstyret er i samsvar med de grunnleggende krav og andre relevante bestemmelser i EU-direktiv 2014/53/EF.
<b>Polski [Polish]</b>	Urządzenie jest zgodne z ogólnymi wymaganiami oraz szczególnymi mi warunkami określony mi Dyrektywą UE:2014/53/EC.
<b>Português [Portuguese]</b>	Este equipamento está em conformidade com os requisitos essenciais e outras provisões relevantes da Directiva 2014/53/EC.
<b>Slovensko [Slovenian]</b>	Ta naprava je skladna z bistvenimi zahtevami in ostalimi relevantnimi popoji Direktive 2014/53/EC.
<b>Slovensky [Slovak]</b>	Toto zariadenie je v zhode so základnými požiadavkami a inými príslušnými nariadeniami direktiv: 2014/53/EC.
<b>Suomi [Finnish]</b>	Tämä laite täyttää direktiivin 2014/53/EY olennaiset vaatimukset ja on siinä asetettujen muiden laitetta koskevien määräysten mukainen.
<b>Svenska [Swedish]</b>	Denna utrustning är i överensstämmelse med de väsentliga kraven och andra relevanta bestämmelser i Direktiv 2014/53/EC.

### CE Marking

For the Riverbed Xirus Wireless AP, the CE mark and Class-2 identifier opposite are affixed to the equipment and its packaging:



## Russian Certification Marking

For the Riverbed XR-500, XR-520H, XR-2000, and XR-4000 Series Wireless APs, the approval mark is affixed to the equipment:



## WEEE Compliance



- Natural resources were used in the production of this equipment.
- This equipment may contain hazardous substances that could impact the health of the environment.
- In order to avoid harm to the environment and consumption of natural resources, we encourage you to use appropriate take-back systems when disposing of this equipment.
- The appropriate take-back systems will reuse or recycle most of the materials of this equipment in a way that will not harm the environment.
- The crossed-out wheeled bin symbol (in accordance with European Standard EN 50419) invites you to use those take-back systems and advises you not to combine the material with refuse destined for a land fill.
- If you need more information on collection, re-use and recycling systems, please contact your local or regional waste administration.
- Please contact Riverbed Xirrus for specific information on the environmental performance

### National Restrictions

In the majority of the EU and other European countries, the 2.4 GHz and 5 GHz bands have been made available for the use of Wireless LANs. The following table provides an overview of the regulatory requirements in general that are applicable for the 2.4 GHz and 5 GHz bands.

Frequency Band (MHz)	Max Power Level (EIRP) (mW)	Indoor	Outdoor
2400–2483.5	100	X	X **
5250–5350 *	200	X	N/A
5470–5725*	1000	X	X

*\*Dynamic frequency selection and Transmit Power Control is required in these frequency bands.*

*\*\*France is indoor use only in the upper end of the band.*

The requirements for any country may change at any time. Riverbed Xirrus recommends that you check with local authorities for the current status of their national regulations for both 2.4 GHz and 5 GHz wireless LANs.

The following countries have additional requirements or restrictions than those listed in the above table:

### Belgium

The Belgian Institute for Postal Services and Telecommunications (BIPT) must be notified of any outdoor wireless link having a range exceeding 300 meters. Riverbed Xirrus recommends checking at [www.bipt.be](http://www.bipt.be) for more details.

*Draadloze verbindingen voor buitengebruik en met een reikwijdte van meer dan 300 meter dienen aangemeld te worden bij het Belgisch Instituut voor postdiensten en telecommunicatie (BIPT). Zie [www.bipt.be](http://www.bipt.be) voor meer gegevens.*

*Les liaisons sans fil pour une utilisation en extérieur d'une distance supérieure à 300 mètres doivent être notifiées à l'Institut Belge des services Postaux et des Télécommunications (IBPT). Visitez [www.bipt.be](http://www.bipt.be) pour de plus amples détails.*

### Greece

A license from EETT is required for the outdoor operation in the 5470 MHz to 5725 MHz band. Riverbed Xirrus recommends checking [www.eett.gr](http://www.eett.gr) for more details.

*Η δη ιουργβάικτ ωνεξωτερικo ρουστη ζ νησυ νοτ των 5470–5725 MHz ε ιτρ ετάιωνo ετάά οάδειά της EETT, ου ορηγεβτάί στερά ά ό σ φωνη γν η του ΓΕΕΘΑ. ερισσότερες λε τομ ρειεωστο [www.eett.gr](http://www.eett.gr)*

### Italy

This product meets the National Radio Interface and the requirements specified in the National Frequency Allocation Table for Italy. Unless this wireless LAN product is operating within the boundaries of the owner's property, its use requires a "general authorization." Please check with [www.comunicazioni.it/it/](http://www.comunicazioni.it/it/) for more details.

*Questo prodotto é conforme alla specifiche di Interfaccia Radio Nazionali e rispetta il Piano Nazionale di ripartizione delle frequenze in Italia. Se non viene installato all'interno del proprio fondo, l'utilizzo di prodotti wireless LAN richiede una "autorizzazione Generale." Consultare [www.comunicazioni.it/it/](http://www.comunicazioni.it/it/) per maggiori dettagli.*

### Norway, Switzerland and Liechtenstein

Although Norway, Switzerland and Liechtenstein are not EU member states, the EU Directive 2014/53/EC has also been implemented in those countries.

## Calculating the Maximum Output Power

The regulatory limits for maximum output power are specified in EIRP (radiated power). The EIRP level of a device can be calculated by adding the gain of the

antenna used (specified in dBi) to the output power available at the connector (specified in dBm).

### Integrated Antennas

Riverbed Xirrus Wireless APs (except for XA4 APs) employ integrated antennas that cannot be removed and which are not user accessible. Nevertheless, as regulatory limits are not the same throughout the EU, users may need to adjust the conducted power setting for the radio to meet the EIRP limits applicable in their country or region. Adjustments can be made from the product's management interface—either Web Management Interface (WMI) or Command Line Interface (CLI).

### External Antennas (for XA4 only)

- ! **WARNING:** In order to comply with radio frequency (RF) exposure limits, the antennas for this product should be positioned no less than 34 cm from your body or nearby persons.
- ! **WARNING:** Do not locate the antenna near overhead power lines or other electric light or power circuits, or where it can come into contact with such circuits. When installing the antenna, take extreme care not to come into contact with such circuits, because they may cause serious injury or death. For proper installation and grounding of the antenna, please refer to national and local codes (for example, U.S.:NFPA 70, National Electrical Code, Article 810, Canada: Canadian Electrical Code, Section 54).
- ! To reduce potential radio interference to other users, the antenna type and its gain should be so chosen that the equivalent isotropically radiated power (EIRP) is not more than that permitted for successful communication.

### Operating Frequency

The operating frequency in a wireless LAN is determined by the access point. As such, it is important that the access point is correctly configured to meet the local regulations. See [National Restrictions](#) in this section for more information.

If you still have questions regarding the compliance of Riverbed Xirrus products or you cannot find the information you are looking for, please contact us at:

Riverbed Technology  
680 Folsom Street  
San Francisco, CA 94107  
USA

Tel: 1-888-RVBD-TAC (1-888-782-3822)  
+1 415-247-7381

[www.riverbed.com](http://www.riverbed.com)

## Compliance Information (Non-EU)



*This Appendix contains Notices, Warnings, and Compliance information for the XA, XD and XR500/600 Series only. For other models, see the notes at the beginning of this appendix.*

This section contains compliance information for the Riverbed Xirrus Wireless AP family of products. The compliance information contained in this section is relevant to the listed countries (outside of the European Union and other countries that have implemented the EU Directive 2014/53/EC).



## Declaration of Conformity—Brazil

**For XR-500 Only**



## Declaration of Conformity

**Korea** XD2-240 and XD4-240 operation in the DFS band:

해당무선설비는전파혼신가능성이있으므로인명  
안전과관련된서비스는할수없음

XD2240 KC—R-CRM-R2T-XD2240

XD4240 KC—R-CRM-R2T-XD4240

**Mexico** XR-520: Dictamen #: 1402D00742

XR-600: Dictamen #: 1402CE08098



XR-520: Cofetel Cert #: RCPXIXR13-1003

**South Africa** South Africa-ICASA Cert  
X2120 and XD2240 Approved ID: TA-2018/1427

**Thailand** This telecommunication equipment conforms to  
NTC technical requirement.

## Safety Warnings



*This Appendix contains Notices, Warnings, and Compliance information for the XA, XD and XR500/600 Series only. For other models, see the notes at the beginning of this appendix.*

### **Safety Warnings**

Read all user documentation before powering this device. All Riverbed Xirrus interconnected equipment should be contained indoors. This product is not suitable for outdoor operation. Please verify the integrity of the system ground prior to installing Riverbed Xirrus equipment. Additionally, verify that the ambient operating temperature does not exceed 50°C (40°C for the XR500/600 Series).

### **Circuit Breaker Warning**

The indoor wireless AP relies on the building's installation for over current protection. Ensure that a fuse or circuit breaker no larger than 120 VAC, 15A (U.S.) or 240 VAC, 10A (International) is used on all current-carrying conductors.

### **Explosive Device Proximity Warning**

Do not operate the wireless AP near unshielded blasting caps or in an explosive environment unless the device has been modified to be especially qualified for such use.

### **Lightning Activity Warning**

Do not work on the Wireless AP or connect or disconnect cables during periods of lightning activity.

Translated safety warnings appear below.

## Translated Safety Warnings



*This Appendix contains Notices, Warnings, and Compliance information for the XA, XD and XR500/600 Series only. For other models, see the notes at the beginning of this appendix.*

## Avertissements de Sécurité

- ! **Sécurité**

Lisez l'ensemble de la documentation utilisateur avant de mettre cet appareil sous tension. Tous les équipements Riverbed Xirrus interconnectés doivent être installés en intérieur. Ce produit n'est pas conçu pour être utilisé en extérieur. Veuillez vérifier l'intégrité de la terre du système avant d'installer desvs équipements Riverbed. Vérifiez également que la température de fonctionnement ambiante n'excède pas 50°C (40°C pour XR-520).
  
- ! **Proximité d'appareils explosifs**

N'utilisez pas les Wireless APs à proximité d'amorces non blindées ou dans un environnement explosif, à moins que l'appareil n'ait été spécifiquement modifié pour un tel usage.
  
- ! **Foudre**

N'utilisez pas les Wireless APs et ne branchez pas ou ne débranchez pas de câbles en cas de foudre.
  
- ! **Disjoncteur**

Les Wireless APs dépend de l'installation du bâtiment pour ce qui est de la protection contre les surintensités. Assurez-vous qu'un fusible ou qu'un disjoncteur de 120 Vca, 15 A (États-Unis) ou de 240 Vca, 10 A (International) maximum est utilisé sur tous les conducteurs de courant.

## Software and Hardware License and Warranty Agreement

For Software License and Product Warranty information, please see <https://www.riverbed.com/legal/license.html>.

## Appendix D: Notices (XR-1000 to XR-6000 Indoor Models)



*This Appendix contains Notices, Warnings, and Compliance information for these indoor model series: XR-1000, XR-2000, XR-4000, and XR-6000. This includes the models just listed whether or not they have been upgraded to have IEEE 802.11ac Wave2 wireless capability by replacing existing radios with XI-AC3470 modules.*

*For the XR-500/600/XD Series, please see “Notices (XA, XD and XR500/600 Series Only)” on page 557.*

*For models including the letter H (such as the XR-520H and XH2-120), please see the Quick Installation Guide for that model.*

*For Notices, Warnings, and Compliance information for XR-320 and X2-120, please see the X2 and XR300 Series Notices and Regulatory Guide.*

This appendix contains the following information:

- **“Notices” on page 577**
- **“EU Compliance Information” on page 582**
- **“Compliance Information (Non-EU)” on page 589**
- **“Safety Warnings” on page 591**
- **“Translated Safety Warnings” on page 592**
- **“Software and Hardware License and Warranty Agreement” on page 594**

### Notices

#### Wi-Fi Alliance Certification



[www.wi-fi.org](http://www.wi-fi.org)

### **FCC Notice**

This equipment has been tested and found to comply with the limits for a Class A digital device, pursuant to part 15 of the FCC Rules. These limits are designed to provide reasonable protection against harmful interference when the equipment is operated in a commercial environment. This equipment generates, uses, and can radiate radio frequency energy and, if not installed and used in accordance with the instruction manual, may cause harmful interference to radio communications. Operation of this equipment in a residential area is likely to cause harmful interference in which case the user will be required to correct the interference at his own expense.

Use of a shielded twisted pair (STP) cable must be used for all Ethernet connections in order to comply with EMC requirements.

This device complies with Part 15 of the FCC Rules, with operation subject to the following two conditions: (1) This device may not cause harmful interference, and (2) this device must accept any interference received, including interference that may cause unwanted operation.

### **High Power Radars**

High power radars are allocated as primary users (meaning they have priority) in the 5250MHz to 5350MHz and 5650MHz to 5850MHz bands. These radars could cause interference and/or damage to LE-LAN devices.

### **Non-Modification Statement**

Unauthorized changes or modifications to the device are not permitted. Use only the supplied internal antenna, or external antennas supplied by the manufacturer. Modifications to the device will void the warranty, void the user's authority to operate the equipment, and may violate FCC regulations (Reference: FCC Part 15, section 15.21). Please see the Xirrus Web site for a list of all approved antennas.

### **Cable Runs for Power over Gigabit Ethernet (PoGE)**

If using PoGE, the Array must be connected to PoGE networks without routing cabling to the outside plant—this ensures that cabling is not exposed to lightning strikes or possible cross over from high voltage.

## UL Statement

Use only with listed ITE product.

## Battery Warning

- ! **Caution!** The AP contains a battery which is not to be replaced by the customer. Danger of Explosion exists if the battery is incorrectly replaced. Replace only with the same or equivalent type recommended by the manufacturer. Dispose of used batteries according to the manufacturer's instructions.

## RF Radiation Hazard Warning (FCC and Industry Canada)

For APs with IEEE 802.11ac Wave2 radios, install the unit being careful to keep the separation distances indicated in the table below between radiating elements of access point and users. This is consistent with the security warning exposure limits specified by the RSS-102 to relative radio frequencies.

*Pour les appareils IEEE 802.11ac Wave2, installez l'appareil en veillant à conserver les distances de séparation indiquées dans la table ci-dessus entre les éléments rayonnants et les personnes. Cet avertissement de sécurité est conforme aux limites d'exposition définies par la norme CNR-102 relative aux fréquences radio.*

802.11ac Wave2 Modules (Radios) in AP	FCC Separation Distance (cm)	IC Separation Distance (cm)
1 module	20.0	21.2
XR6000 - 12 modules	51.3	51.6
XR4000 - 8 modules	44.0	50.8
XR2000 - 4 modules	31.1	39.9

For other APs, to ensure compliance with FCC and Industry Canada (IC) RF exposure requirements, this device must be installed in a location where the antennas of the device will have a minimum distance of at least 30 cm (12 inches) from all persons.

*Pour les autres appareils, installez l'appareil en veillant à conserver une distance d'au moins 30 cm entre les éléments rayonnants et les personnes. Cet avertissement de sécurité est conforme aux limites d'exposition définies par la norme CNR-102 at relative aux fréquences radio.*

### **Industry Canada Notice and Marking**

This Class A digital apparatus complies with Canadian ICES-003.

*Cet appareil numérique de la classe A est conforme à la norme NMB-003 du Canada.*

The term "IC:" before the radio certification number only signifies that Industry Canada technical specifications were met.

Under Industry Canada regulations, this radio transmitter may only operate using an antenna of a type and maximum (or lesser) gain approved for the transmitter by Industry Canada. To reduce potential radio interference to other users, the antenna type and its gain should be so chosen that the equivalent isotropically radiated power (e.i.r.p.) is not more than that necessary for successful communication.

*Conformément à la réglementation d'Industrie Canada, le présent émetteur radio peut fonctionner avec une antenne d'un type et d'un gain maximal (ou inférieur) approuvé pour l'émetteur par Industrie Canada. Dans le but de réduire les risques de brouillage radioélectrique à l'intention des autres utilisateurs, il faut choisir le type d'antenne et son gain de sorte que la puissance isotrope rayonnée équivalente (p.i.r.e.) ne dépasse pas l'intensité nécessaire à l'établissement d'une communication satisfaisante.*

This device complies with Industry Canada license-exempt RSS standard(s). Operation is subject to the following two conditions: (1) this device may not cause interference, and (2) this device must accept any interference, including interference that may cause undesired operation of the device.

*Le présent appareil est conforme aux CNR d'Industrie Canada applicables aux appareils radio exempts de licence. L'exploitation est autorisée aux deux conditions suivantes: (1) l'appareil ne doit pas produire de brouillage, et (2) l'utilisateur de l'appareil doit accepter tout brouillage radioélectrique subi, même si le brouillage est susceptible d'en compromettre le fonctionnement.*



This equipment should be installed and operated with a minimum distance of 30cm between the radiator and your body.

*Cet équipement doit être installé et utilisé à une distance minimale de 30cm entre le radiateur et votre corps.*

### **High Power Radars**

High power radars are allocated as primary users (meaning they have priority) in the 5250MHz to 5350MHz and 5650MHz to 5850MHz bands. These radars could cause interference and/or damage to LELAN devices used in Canada.

*Les utilisateurs de radars de haute puissance sont désignés utilisateurs principaux (c.-à-d., qu'ils ont la priorité) pour les bandes 5 250 - 5 350 MHz et 5 650 - 5 850 MHz. Ces radars pourraient causer du brouillage et/ou des dommages aux dispositifs LAN-EL.*

## EU Compliance Information



*This section applies to these indoor model series: XR-2000 and XR-4000. This includes the models just listed whether or not they have been upgraded to have additional wireless capability by replacing existing radios with XIAC867, XIAC1300, or XI-AC3470 modules.*

*For Notices, Warnings, and Compliance information for other models, see the notes at the beginning of this chapter.*

### **Radio Equipment Directive (RED) 2014/53/EU Compliance Information**

Frequencies from 5150 to 5350 (5 GHz channels 36-64) are restricted to indoor use only.



AT	BE	BG	CH	CY	CZ	DE	DK	EE	EL	ES
FI	FR	HR	HU	IE	IS	IT	LI	LT	LU	LV
MT	NL	NO	PL	PT	RO	SE	SI	SK	TR	UK

This section contains compliance information for the Xirrus Wireless AP family of products. The compliance information contained in this section is relevant to the European Union and other countries that have implemented the EU Directive 2014/53/EC.

Riverbed, Inc. declares that these radio equipment types [XR600, XR2000 and XR4000 Series APs; XD2240, XD4130, XD4240, and XA4240 APs; and XIAC867, XIAC1300, and XIAC3470 radio modules] are in compliance with Directive 2014/53/EU. The full text of the EU declaration of conformity is available at the following internet address: [www.xirrus.com/declarations-of-conformity/](http://www.xirrus.com/declarations-of-conformity/).

### **Declaration of Conformity**

#### **Cesky [Czech]**

Toto zařízení je v souladu se základními požadavky a ostatními odpovídajícími ustanoveními směrnice 2014/53/EC.

<b>Dansk [Danish]</b>	Dette udstyr er i overensstemmelse med de væsentlige krav og andre relevante bestemmelser i Direktiv 2014/53/EF.
<b>Deutsch [German]</b>	Dieses Gerat entspricht den grundlegenden Anforderungen und den weiteren entsprechenden Vorgaben der Richtlinie 2014/53/EU.
<b>Eesti [Estonian]</b>	See seande vastab direktiivi 2014/53/EU olulistele nõuetele ja teistele asjakohastele sätetele.
<b>English</b>	This equipment is in compliance with the essential requirements and other relevant provisions of Directive 2014/53/EC.
<b>Español [Spain]</b>	Este equipo cumple con los requisitos esenciales así como con otras disposiciones de la Directiva 2014/53/CE.
<b>Ελληνική [Greek]</b>	Αυτό το εξοπλισμός είναι σε συμμόρφωση με τις ουσιαστικές απαιτήσεις και άλλες σχετικές διατάξεις της Οδηγίας 2014/53/ΕΚ.
<b>Français [French]</b>	Cet appareil est conforme aux exigences essentielles et aux autres dispositions pertinentes de la Directive 2014/53/EC.
<b>Íslenska [Icelandic]</b>	Þetta tæki er samkvæmt grunnkröfum og öðrum viðeigandi ákvæðum Tilskipunar 2014/53/EC.
<b>Italiano [Italian]</b>	Questo apparato é conforme ai requisiti essenziali ed agli altri principi sanciti dalla Direttiva 2014/53/CE.
<b>Latviski [Latvian]</b>	Šī iekārta atbilst Direktīvas 2014/53/EK būtiskajā prasībā un citiem ar to saistītajiem noteikumiem.
<b>Lietuvių [Lithuanian]</b>	Šis įrenginys tenkina 2014/53/EB Direktyvos esminius reikalavimus ir kitas šios direktyvos nuostatas.
<b>Nederlands [Dutch]</b>	Dit apparaat voldoet aan de essentiële eisen en andere van toepassing zijnde bepalingen van de Richtlijn 2014/53/EC.

<b>Malti [Maltese]</b>	Dan l-apparant huwa konformi mal-htigiet essenzjali u l-provedimenti l-oħra rilevanti tad-Direttiva 2014/53/EC.
<b>Magyar [Hungarian]</b>	Ez a készülék teljesíti az alapvető követelményeket és más 2014/53/EK irányelvben meghatározott vonatkozó rendelkezéseket.
<b>Norsk [Norwegian]</b>	Dette utstyret er i samsvar med de grunnleggende krav og andre relevante bestemmelser i EU-direktiv 2014/53/EF.
<b>Polski [Polish]</b>	Urządzenie jest zgodne z ogólnymi wymaganiami oraz szczególnymi mi warunkami określony mi Dyrektywą UE:2014/53/EC.
<b>Português [Portuguese]</b>	Este equipamento está em conformidade com os requisitos essenciais e outras provisões relevantes da Directiva 2014/53/EC.
<b>Slovensko [Slovenian]</b>	Ta naprava je skladna z bistvenimi zahtevami in ostalimi relevantnimi popoji Direktive 2014/53/EC.
<b>Slovensky [Slovak]</b>	Toto zariadenie je v zhode so základnými požiadavkami a inými príslušnými nariadeniami direktív: 2014/53/EC.
<b>Suomi [Finnish]</b>	Tämä laite täyttää direktiivin 2014/53/EY olennaiset vaatimukset ja on siinä asetettujen muiden laitetta koskevien määräysten mukainen.
<b>Svenska [Swedish]</b>	Denna utrustning är i överensstämmelse med de väsentliga kraven och andra relevanta bestämmelser i Direktiv 2014/53/EC.

## CE Marking

For the Xirrus Wireless Array, the CE mark and Class-2 identifier opposite are affixed to the equipment and its packaging:



## WEEE Compliance



- Natural resources were used in the production of this equipment.
- This equipment may contain hazardous substances that could impact the health of the environment.
- In order to avoid harm to the environment and consumption of natural resources, we encourage you to use appropriate take-back systems when disposing of this equipment.
- The appropriate take-back systems will reuse or recycle most of the materials of this equipment in a way that will not harm the environment.
- The crossed-out wheeled bin symbol (in accordance with European Standard EN 50419) invites you to use those take-back systems and advises you not to combine the material with refuse destined for a land fill.
- If you need more information on collection, re-use and recycling systems, please contact your local or regional waste administration.
- Please contact Xirrus for specific information on the environmental performance of our products.

## National Restrictions

In the majority of the EU and other European countries, the 2.4 GHz and 5 GHz bands have been made available for the use of Wireless LANs. The following table provides an overview of the regulatory requirements in general that are applicable for the 2.4 GHz and 5 GHz bands.

Frequency Band (MHz)	Max Power Level (EIRP) (mW)	Indoor	Outdoor
2400–2483.5	100	X	X **
5250–5350 *	200	X	N/A
5470–5725*	1000	X	X

*\*Dynamic frequency selection and Transmit Power Control is required in these frequency bands.*

*\*\*France is indoor use only in the upper end of the band.*

The requirements for any country may change at any time. Xirrus recommends that you check with local authorities for the current status of their national regulations for both 2.4 GHz and 5 GHz wireless LANs.

The following countries have additional requirements or restrictions than those listed in the above table:

### Belgium

The Belgian Institute for Postal Services and Telecommunications (BIPT) must be notified of any outdoor wireless link having a range exceeding 300 meters. Xirrus recommends checking at [www.bipt.be](http://www.bipt.be) for more details.

*Draadloze verbindingen voor buitengebruik en met een reikwijdte van meer dan 300 meter dienen aangemeld te worden bij het Belgisch Instituut voor postdiensten en telecommunicatie (BIPT). Zie [www.bipt.be](http://www.bipt.be) voor meer gegevens.*

*Les liaisons sans fil pour une utilisation en extérieur d'une distance supérieure à 300 mètres doivent être notifiées à l'Institut Belge des services Postaux et des Télécommunications (IBPT). Visitez [www.bipt.be](http://www.bipt.be) pour de plus amples détails.*

### Greece

A license from EETT is required for the outdoor operation in the 5470 MHz to 5725 MHz band. Xirrus recommends checking [www.eett.gr](http://www.eett.gr) for more details.

*Η δη ιουργβάικτ ωνεξωτερικο ρουστη ζ νησυ νοτ των 5470–5725 MHz ε ιτρ ετάιωνο ετάά όάδειά της EETT, ου ορηγεβτάι στερά ά ό σ φωνη γν η του ΓΕΕΘΑ. ερισσότερες λε τομ ρειεωστο [www.eett.gr](http://www.eett.gr)*

### Italy

This product meets the National Radio Interface and the requirements specified in the National Frequency Allocation Table for Italy. Unless this wireless LAN product is operating within the boundaries of the owner's property, its use requires a "general authorization." Please check with [www.comunicazioni.it/it/](http://www.comunicazioni.it/it/) for more details.

*Questo prodotto é conforme alla specifiche di Interfaccia Radio Nazionali e rispetta il Piano Nazionale di ripartizione delle frequenze in Italia. Se non viene installato all'interno del proprio fondo, l'utilizzo di prodotti wireless LAN richiede una "autorizzazione Generale." Consultare [www.comunicazioni.it/it/](http://www.comunicazioni.it/it/) per maggiori dettagli.*

### Norway, Switzerland and Liechtenstein

Although Norway, Switzerland and Liechtenstein are not EU member states, the EU Directive 2014/53/EC has also been implemented in those countries.

## Calculating the Maximum Output Power

The regulatory limits for maximum output power are specified in EIRP (radiated power). The EIRP level of a device can be calculated by adding the gain of the antenna used (specified in dBi) to the output power available at the connector (specified in dBm).

## Antennas

The Xirrus Wireless Array employs integrated antennas that cannot be removed and which are not user accessible. Nevertheless, as regulatory limits are not the same throughout the EU, users may need to adjust the conducted power setting for the radio to meet the EIRP limits applicable in their country or region. Adjustments can be made from the product's management interface—either Web Management Interface (WMI) or Command Line Interface (CLI).

## Operating Frequency

The operating frequency in a wireless LAN is determined by the access point. As such, it is important that the access point is correctly configured to meet the local regulations. See [National Restrictions](#) in this section for more information.

## Russia CU Approval (XR-2000/4000 Series)

For the Xirrus XR-2000 and XR-4000 Series Wireless Arrays, the approval mark is affixed to the equipment:



If you still have questions regarding the compliance of Xirrus products or you cannot find the information you are looking for, please contact us at:

Xirrus, Inc.  
2101 Corporate Center Drive  
Thousand Oaks, CA 91320  
USA  
Tel: 1.805.262.1600  
1.800.947.7871 Toll Free in the US  
Fax: 1.866.462.3980

[www.riverbed.com](http://www.riverbed.com)



## Compliance Information (Non-EU)



*This Appendix contains Notices, Warnings, and Compliance information for these indoor model series: XR-1000, XR-2000, XR-4000, and XR-6000. This includes the models just listed whether or not they have been upgraded to have IEEE 802.11ac Wave2 wireless capability by replacing existing radios with XI-AC3470 modules.*

*For Notices, Warnings, and Compliance information for other models, see the notes at the beginning of this chapter.*

This section contains compliance information for the Xirrus Wireless Array family of products. The compliance information contained in this section is relevant to the listed countries (outside of the European Union and other countries that have implemented the EU Directive 2014/53/EC).

### Declaration of Conformity—Mexico, Thailand

**Mexico** XR-1000, XR-2000, XR-4000, XR-6000/7000

Dictamen #: 1402D00741

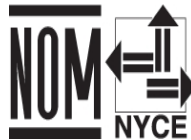

Models with 2x2 radios:

Cofetel Cert #: RCPXIXI13-0807

Models with 3x3 radios:

Cofetel Cert #: RCPXIXI13-0808

**Thailand** This telecommunication equipment conforms to NTC technical requirement.

## Declaration of Conformity—Brazil

## XR-1000



## XR-2000



## XR-4000



## Safety Warnings



*This Appendix contains Notices, Warnings, and Compliance information for these indoor model series: XR-1000, XR-2000, XR-4000, and XR-6000. This includes the models just listed whether or not they have been upgraded to have IEEE 802.11ac Wave2 wireless capability by replacing existing radios with XI-AC3470 modules.*

*For Notices, Warnings, and Compliance information for other models, see the notes at the beginning of this chapter.*

### **Safety Warnings**

Read all user documentation before powering this device. All Xirrus interconnected equipment should be contained indoors. This product is not suitable for outdoor operation. Please verify the integrity of the system ground prior to installing Xirrus equipment. Additionally, verify that the ambient operating temperature does not exceed 50°C.

### **Explosive Device Proximity Warning**

Do not operate the XR Series Wireless Array near unshielded blasting caps or in an explosive environment unless the device has been modified to be especially qualified for such use.

### **Lightning Activity Warning**

Do not work on the XR Series Wireless Array or connect or disconnect cables during periods of lightning activity.

### **Circuit Breaker Warning**

The XR Series Wireless Array relies on the building's installation for over current protection. Ensure that a fuse or circuit breaker no larger than 120 VAC, 15A (U.S.) or 240 VAC, 10A (International) is used on all current-carrying conductors.

Translated safety warnings appear on the following page.

---

## Translated Safety Warnings



*This Appendix contains Notices, Warnings, and Compliance information for these indoor model series: XR-1000, XR-2000, XR-4000, and XR-6000. This includes the models just listed whether or not they have been upgraded to have IEEE 802.11ac Wave2 wireless capability by replacing existing radios with XI-AC3470 modules.*

*For Notices, Warnings, and Compliance information for other models, see the notes at the beginning of this chapter.*

## Avertissements de Sécurité

### Sécurité

Lisez l'ensemble de la documentation utilisateur avant de mettre cet appareil sous tension. Tous les équipements Xirrus interconnectés doivent être installés en intérieur. Ce produit n'est pas conçu pour être utilisé en extérieur. Veuillez vérifier l'intégrité de la terre du système avant d'installer des équipements Xirrus. Vérifiez également que la température de fonctionnement ambiante n'excède pas 50°C (40°C pour XR-520).

### Proximité d'appareils explosifs

N'utilisez pas l'unité XR Wireless Array à proximité d'amorces non blindées ou dans un environnement explosif, à moins que l'appareil n'ait été spécifiquement modifié pour un tel usage.

### Foudre

N'utilisez pas l'unité XR Wireless Array et ne branchez pas ou ne débranchez pas de câbles en cas de foudre.



### Disjoncteur

L'unité XR Wireless Array dépend de l'installation du bâtiment pour ce qui est de la protection contre les surintensités. Assurez-vous qu'un fusible ou qu'un disjoncteur de 120 Vca, 15 A (États-Unis) ou de 240 Vca, 10 A (International) maximum est utilisé sur tous les conducteurs de courant.

## **Software and Hardware License and Warranty Agreement**

For Software License and Product Warranty information, please see <https://www.riverbed.com/legal/license.html>.

## Appendix E: Medical Usage Notices

Riverbed wireless devices have been tested and found to comply with the requirements of IEC 60601-1-2.

**Section 5.2.1.1** - Riverbed wireless devices need special precautions regarding EMC and must be installed and put into service according to the EMC information provided in this User’s Guide and in the Quick Installation Guide for the Riverbed AP.

Portable and mobile RF communications equipment can affect Medical Electrical Equipment.

### Section 5.2.2.1 (c)

Table 1

<b>Guidance and manufacturer’s declaration – electromagnetic emissions</b>		
The Riverbed wireless device is intended for use in the electromagnetic environment specified below. The customer or the user of the Riverbed device should assure that it is used in such an environment.		
<b>Emissions test</b>	<b>Compliance</b>	<b>Electromagnetic environment – guidance</b>
RF emissions CISPR 11	Group 1	Riverbed wireless devices are in compliance with the emissions requirements in CISPR 11. Therefore, their RF emissions are not likely to cause any interference in nearby electronic equipment.
RF emissions CISPR 11	Class A	Riverbed wireless devices are suitable for use in all establishments other than domestic and those directly connected to the public low-voltage power supply network that supplies buildings used for domestic purposes.
Harmonic emissions IEC 61000-3-2	Not Applicable	
Voltage fluctuations/flicker emissions IEC 61000-3-3	Not Applicable	

**Section 5.2.2.1 (d)** – The Riverbed wireless device should not be used adjacent to or stacked with other equipment. If adjacent or stacked use is necessary, the equipment should be observed to verify normal operation in the configuration in which it will be used.

## Section 5.2.2.1 (f)

Table 2

<b>Guidance and manufacturer's declaration – electromagnetic immunity</b>			
Riverbed wireless devices are intended for use in the electromagnetic environment specified below. The customer or the user of the Riverbed wireless device should assure that it is used in such an environment.			
Immunity test	IEC 60601 test level	Compliance level	Electromagnetic environment - guidance
Electrostatic Discharge (ESD) IEC 61000-4-2	± 6 kV contact ± 8 kV air	± 6 kV contact ± 8 kV air	Floors should be wood, concrete or ceramic tile. If floors are covered with synthetic material, the relative humidity should be at least 30%.
Electrical fast transient/burst IEC 61000-4-4	± 2 kV for power supply lines ± 1 kV for input/output lines	Not applicable for power supply lines  ± 1 kV for input/output lines	
Surge IEC 61000-4-5	± 1 kV line(s) to line(s) ± 2 kV line(s) to earth	Not applicable	Not applicable
Voltage dips, short interruptions and voltage variations on power supply input lines IEC 61000-4-11	<5% $U_t$ (>95% dip in $U_t$ ) for 0.5 cycle  40% $U_t$ (60% dip in $U_t$ ) for 5 cycles  70% $U_t$ (30% dip in $U_t$ ) for 25 cycles  <5% $U_t$ (>95% dip in $U_t$ ) for 5 s	Not applicable	Not applicable
Power frequency (50/60 Hz) magnetic field IEC 61000-4-8	3 A/m	3 A/m	Power frequency magnetic fields should be at levels characteristic of a typical location in a typical commercial or hospital environment.
NOTE $U_t$ is the a.c. mains voltage prior to application of the test level.			



**Section 5.2.2.1 (g)** Riverbed Wireless devices have no essential performance per IEC 60601-1-2.

**Section 5.2.2.2** – Tables 4 and 6

Table 4 for non-life supporting equipment

<b>Guidance and manufacturer's declaration – electromagnetic immunity</b>			
Riverbed wireless devices are intended for use in the electromagnetic environment specified below. The customer or the user of the Riverbed device should assure that it is used in such an environment.			
Immunity test	IEC 60601 test level	Compliance level	Electromagnetic environment - guidance

<p>Conducted RF IEC 61000-4-6</p> <p>Radiated RF IEC61000-4-3</p>	<p>3 Vrms 150 kHz to 80 MHz</p> <p>3 V/m 80 MHz to 2.5 GHz</p>	<p>3 V</p> <p>3 V/m</p>	<p>Portable and mobile RF communication equipment should be no closer to any part of the Riverbed wireless device, including cables, than the recommended separation distance calculated from the equation applicable to the frequency of the transmitter.</p> <p>Recommended separation distance</p> <p><math>d = 1.17 \cdot \sqrt{P}</math></p> <p><math>d = 1.17 \cdot \sqrt{P}</math> 80 MHz to 800 MHz</p> <p><math>d = 2.33 \cdot \sqrt{P}</math> 800 MHz to 2.5 GHz</p> <p>Where <math>P</math> is the maximum output power rating of the transmitter in watts (W) according to the transmitter manufacturer and <math>d</math> is the recommended separation distance in metres (m).</p> <p>Field strengths from fixed RF transmitters, as determined by an electromagnetic site survey<sup>a</sup>, should be less than the compliance level in each frequency range<sup>b</sup>.</p> <p> Interference may occur in the vicinity of equipment marked with this symbol:</p>
<p>NOTE 1 At 80 MHz and 800 MHz, the higher frequency range applies.</p>			
<p>NOTE 2 These guidelines may not apply in all situations. Electromagnetic propagation is affected by absorption and reflection from structures, objects and people.</p>			

<sup>a</sup> Field strengths from fixed transmitters, such as base stations for radio (cellular/cordless) telephones and land mobile radios, amateur radio, AM and FM radio broadcast and TV broadcast cannot be predicted theoretically with accuracy. To assess the electromagnetic environment due to fixed RF transmitters, an electromagnetic site survey should be considered. If the measured field strength in the location in which Riverbed wireless devices are used exceeds the applicable RF compliance level above, the Riverbed wireless device should be observed to verify normal operation. If abnormal performance is observed, additional measures maybe necessary, such as re-orienting or relocating the Riverbed wireless device.

<sup>b</sup> Over the frequency range 150 kHz to 80 MHz, field strengths should be less than 3 V/m.

Table 6 for non-life supporting equipment

<b>Recommended separation distances between Medical Electrical Equipment and Riverbed Wireless Devices</b>			
Riverbed wireless devices are intended for use in an electromagnetic environment in which radiated RF disturbances are controlled. The customer or the user of the Riverbed wireless device can help prevent electromagnetic interference by maintaining a minimum distance between portable and mobile RF communication equipment (transmitters) and the Riverbed wireless device as recommended below, according to the maximum output power of the communications equipment.			
<b>Rated maximum output power of transmitter</b>	<b>Separation distance according to frequency of transmitter</b>		
	<b>m</b>		
<b>W</b>	150 kHz to 80 MHz	80 MHz to 800 MHz	800 MHz to 2.5 GHz
	$d = 1.17* \sqrt{P}$	$d = 1.17* \sqrt{P}$	$d = 2.33* \sqrt{P}$
0.01	0.12	0.12	0.23
0.1	0.37	0.37	0.74
1	1.17	1.17	2.33
10	3.7	3.7	7.37
100	11.7	11.7	23.3
For transmitters rated a maximum output power not listed above, the recommended separation distance d in metres (m) can be estimated using the equation applicable to the frequency of the transmitter, where P is the maximum output power rating of the transmitter in watts (W) according to the transmitter manufacturer.			
NOTE 1 At 80 MHz and 800 MHz, the separation distance for the higher frequency range applies.			
NOTE 2 These guidelines may not apply in all situations. Electromagnetic propagation is affected by absorption and reflection for structures, objects and people.			

**Section 5.2.2.5**

<b>RF Channels Supported in the US</b>	
2.4GHz (Exact channels available will be based on country of operation)	1 2 3 4 5 6 7 8 9 10 11
5GHz (Exact channels available will be based on country of operation)	UNII I – Non-DFS Channels: 36 40 44 48 UNII-2A – DFS channel: 52 56 60 64 UNII-2C – DFS channels: 100 104 108 112 116 132 136 140 144 UNI III – Non-DFS Channels: 149 153 157 161 165

<b>RF Channels Supported in Europe</b>	
2.4GHz (Exact channels available will be based on country of operation)	1 2 3 4 5 6 7 8 9 10 11 12 13
5GHz (Exact channels available will be based on country of operation)	UNII I – Non-DFS Channels: 36 40 44 48 UNII-2A – DFS channel: 52 56 60 64 UNII-2C – DFS channels: 100 104 108 112 116 120 124 128 132 136 140 144 UNI III – Non-DFS Channels: 149 153 157 161 165

Both single channels (20MHz bandwidth) and bonded channels (40MHz bandwidth) are supported in the 2.4Ghz and 5 GHz ranges. For devices that support 802.11ac operation, 80 MHz bandwidth bonded channels in the 5GHz band are also supported.

#### **Section 5.2.2.6**

The types of modulation used include CCK, QSPK, BPSK, DSS, OFDM, 16-QAM, and 64-QAM.

The regulatory limits for maximum output power are specified in EIRP (Effective Isotropic Radiated Power). The EIRP level is the transmit power setting for the IAP (specified in dBm) plus the specific antenna gain of the frequency of operation in dBi. The table below shows worst case EIRP—actual values may be reduced based on country specific regulatory restrictions or installation requirements.

## Wireless Access Point

---

- ! *Riverbed wireless devices may be interfered with by other equipment, even if that other equipment complies with CISPR EMISSION requirements.*

<b>Maximum EIRP</b>	
2.4GHz	36dBm
5150-5250MHz	23dBm
5250-5350MHz	30dBm
5470-5725MHz	30dBm
5725-5850MHz	36dBm



## Appendix F: Auditing PCI DSS

The Payment Card Industry (PCI) Data Security Standard (DSS) was developed by major credit card companies to help those that process credit card transactions (or cardholder information) in order to secure cardholder information and protect it from unauthorized access, fraud and other security issues. The major contributors to the standard are VISA, MasterCard, American Express, JCB, and Discover. The standard also helps consolidate various individual standards that were developed by each of the listed card companies. Merchants or others who process credit card transactions are required to comply with the standard and to prove their compliance by way of an audit from a Qualified Security Assessor.

PCI DSS lays out a set of requirements that must be met in order to provide adequate security for sensitive data.

### Payment Card Industry Data Security Standard Overview

The PCI Data Security Standard (PCI DSS) has 12 main requirements that are grouped into six *control objectives*. The following table lists each control objective and the specific requirements for each objective. For the latest updates to this list, check the PCI Security Standards Web site: [www.pcisecuritystandards.org](http://www.pcisecuritystandards.org).

PCI DSS Control Objectives and Associated Requirements
<p><b>Objective: Build and Maintain a Secure Network</b></p> <ul style="list-style-type: none"><li>● Requirement 1: Install and maintain a firewall configuration to protect cardholder data.</li><li>● Requirement 2: Do not use vendor-supplied defaults for system passwords and other security parameters.</li></ul>
<p><b>Objective: Protect Cardholder Data</b></p> <ul style="list-style-type: none"><li>● Requirement 3: Protect stored cardholder data.</li><li>● Requirement 4: Encrypt transmission of cardholder data across open, public networks.</li></ul>

**PCI DSS Control Objectives and Associated Requirements****Objective: Maintain a Vulnerability Management Program**

- Requirement 5: Use and regularly update anti-virus software.
- Requirement 6: Develop and maintain secure systems and applications.

**Objective: Implement Strong Access Control Measures**

- Requirement 7: Restrict access to cardholder data by business need-to-know.
- Requirement 8: Assign a unique ID to each person with computer access.
- Requirement 9: Restrict physical access to cardholder data.

**Objective: Regularly Monitor and Test Networks**

- Requirement 10: Track and monitor all access to network resources and cardholder data.
- Requirement 11: Regularly test security systems and processes.

**Objective: Maintain an Information Security Policy**

- Requirement 12: Maintain a policy that addresses information security.

## PCI DSS and Wireless

The Riverbed AP provides numerous security features that allow it to be a component of a PCI DSS-compliant network. The following sections indicate the specific features that allow the AP to operate in a PCI DSS mode.



## The Riverbed AP PCI Compliance Configuration

The check list below is designed to help ensure that APs are configured in a manner that is supportive of PCI Data Security Standards. Detailed configuration steps for each item are found in the referenced section of the User’s Guide.

✓	Riverbed AP Configuration for PCI DSS	See...
<ul style="list-style-type: none"> <li>( )</li> <li>( )</li> </ul>	<p>Register at the Riverbed Support Site to ensure notification and access to software updates.</p> <p>Confirm that the latest version of AOS is being used by checking the Riverbed web site.</p>	<p><a href="http://support.riverbed.com">support.riverbed.com</a></p>
<ul style="list-style-type: none"> <li>( )</li> </ul>	<p>Enable PCI Mode after configuring the AP in a PCI compliant state to ensure configuration changes cannot be saved that would invalidate a PCI compliant configuration. This item is covered on the following pages.</p>	<p><a href="#">The pci-audit Command, p. 606</a></p>
<ul style="list-style-type: none"> <li>( )</li> </ul>	<p>Allow only necessary protocols and networks to be accessed by configuring your corporate firewall or using the internal AP firewall.</p>	<p><a href="#">Filters, p. 398</a></p>
<ul style="list-style-type: none"> <li>( )</li> <li>( )</li> <li>( )</li> <li>( )</li> <li>( )</li> <li>( )</li> </ul>	<p>Change the default Admin account password.</p> <p>Remove any unnecessary admin or user accounts.</p> <p>Change the SNMP community string from the default password.</p> <p>Use WPA2 and 802.1x authentication.</p> <p>Change default SSID to a user-defined SSID.</p> <p>Disable SSID broadcast for all PCI compliant SSIDs.</p>	<p><a href="#">Express Setup, p. 167</a></p> <p><a href="#">Admin Management, p. 236</a></p> <p><a href="#">SNMP, p. 201</a></p> <p><a href="#">SSIDs, p. 274 and Global Settings, p. 255</a></p> <p><a href="#">SSIDs, p. 274</a></p> <p><a href="#">SSIDs, p. 274</a></p>
<ul style="list-style-type: none"> <li>( )</li> <li>( )</li> <li>( )</li> </ul>	<p>Enable Secure Shell (ssh) for CLI (command line) access.</p> <p>Confirm telnet access is disabled (done by default).</p> <p>Confirm management over the wireless network is disabled.</p>	<p><a href="#">Management Control, p. 243</a></p> <p><a href="#">Global Settings, p. 325</a></p>

✓	Riverbed AP Configuration for PCI DSS	See...
( )	Check that external RADIUS servers have been configured for use with 802.1x and WPA/WPA2 wireless security.	SSIDs, p. 274 and Global Settings, p. 255
( )	Ensure that AP Administration Accounts are being validated by External RADIUS servers.	Admin RADIUS, p. 240
( )	Ensure that each AP is physically inaccessible such that console ports and management ports are not accessible.	See Indoor Enclosure
( )	Enable Syslog messaging and define a Syslog server on the wired network to receive Syslog messages.	System Log, p. 197
( )	Enable NTP and define an NTP server (optional).	Time Settings (NTP), p. 190
( )	Enable the RF Monitor radio in the AP. Categorize known or approved devices as such. Respond to any alert of unknown or unapproved wireless devices discovered by the RF Monitor.	IAP Settings, p. 319 Rogue Control List, p. 270 Rogues, p. 124

## The pci-audit Command

The AP provides a CLI command, `pci-audit` (part of the `management` command), that checks whether the AP's configuration satisfies PCI DSS wireless requirements. This command does not change any parameters, but will inform you of any violations that exist. Furthermore, the command `pci-audit enable` will put the AP in PCI Mode and monitor changes that you make to the AP's configuration in CLI or the WMI. PCI Mode will warn you (and issue a Syslog message) if the change violates PCI DSS requirements. A warning is issued when a non-compliant change is first applied to the AP, and also if you attempt to save a configuration that is non-compliant. Use this command in conjunction with [The Riverbed AP PCI Compliance Configuration](#) above to ensure that you are using the AP in accordance with the PCI DSS requirements.

The pci-audit command checks items such as:

- Telnet is disabled.
- Admin RADIUS is enabled (admin login authentication is via RADIUS server).
- An external Syslog server is in use.
- All SSIDs must set encryption to WPA or better (which also enforces 802.1x authentication)

Sample output from this command is shown below.

```
SS-AP(config)# pci-audit
PCI audit failure: telnet enabled.
PCI audit failure: admin RADIUS authentication disabled.
PCI audit failure: SSID ssid2 encryption too weak.
PCI audit failure: SSID ssid3 encryption too weak.
PCI audit failure: SSID ssid4 encryption too weak.
PCI audit failure: SSID ssid5 encryption too weak.
PCI audit failure: SSID ssid6 encryption too weak.
```

Figure 224. Sample output of pci-audit command

### Additional Resources

- PCI Security Standards Web site: [www.pcisecuritystandards.org](http://www.pcisecuritystandards.org)
- List of Qualified PCI Security Assessors: [www.pcisecuritystandards.org/pdfs/pci\\_qsa\\_list.pdf](http://www.pcisecuritystandards.org/pdfs/pci_qsa_list.pdf)



## Appendix G: Implementing FIPS Security

APs may be configured to satisfy the requirements for Level 2 of *Federal Information Processing Standard (FIPS) Publication 140-2*. This appendix lists simple steps that must be followed exactly to implement FIPS 140-2, Level 2 on Riverbed APs. The procedures include physical actions, and parameters that must be set in the Web Management Interface (WMI) or Command Line Interface (CLI).



*FIPS certification is granted to specific products running specific software releases. Please log in to [support.riverbed.com](http://support.riverbed.com) and search for **Xirrus FIPS**.*

To set up the AP for FIPS 140-2, Level 2, perform the following procedures:

- “Securing the AP Physically” on page 609
- “To implement FIPS 140-2, Level 2 using WMI” on page 611
- - or - “To implement FIPS 140-2, Level 2 using CLI:” on page 614
- “To check if AP is in FIPS mode:” on page 614

The settings that are required for FIPS Level 2 are discussed in:

- “About FIPS Configuration” on page 615

### Securing the AP Physically

#### Operator Required Actions

The Cryptographic Officer is responsible for the following:

- Applying tamper evident seals to the cryptographic module.
- Controlling any unused tamper evident seals.
- Configuring, controlling, and observing changes to the module (e.g., reconfigurations) where the seals are removed or installed.
- Periodically inspecting the tamper evident seals.

Apply supplied tamper-evident seals to the AP as indicated in the figures below.

**IMPORTANT:**

- Before you apply the tamper-evident seal, clean the area of any grease, dirt, or oil. We recommend using alcohol-based cleaning pads for this.
- Each seal must be applied to straddle both sides of an opening or seam so that it will show if an attempt has been made to open or tamper with the AP or enclosure.

**Applying Tamper Evident Seals**

This section describes applying seals for indoor APs. For outdoor deployments, special outdoor AP models for FIPS must be ordered—these are modified at the factory for FIPS Level 2 compliance.



**Indoor Enclosure, showing AP installed**

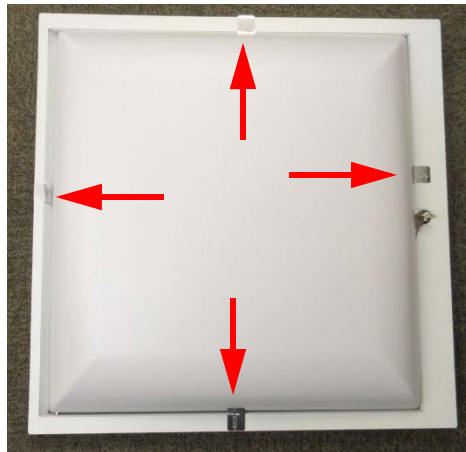

**Place 4 tamper evident seals as shown**

Figure 225. Tamper Evident Seal Application for Indoor Enclosure

1. For Indoor APs: Install the AP in a properly mounted locking Indoor Enclosure, per the instructions in its *Quick Install Guide*. Verify that the AP is operational, then close and lock the enclosure.



2. First verify that the software release running on the unit has been certified for FIPS (see the [Note on page 609](#)). Click **Status > Access Point** in the menu on the left of the WMI window. Then click **Information**. In the **Software Configuration** section, check the **System Software Version**. ([Figure 227](#)) If you have the desired software version, skip to [Step 4](#).

Logged in as: admin			
Ethernet Information: Loaded			
<b>HARDWARE</b>			
Model	XR520, 512MB (300MHz)		
Interface	MAC Address(es)		
Radios	50:60:28:0a:1b:00-0a:1b:1f		
Gigabit 1	50:60:28:00:01:a9		
Component	Part Number	Serial Number	Date
System	XR520	XR502490001A9	unknown
Controller	100-0154-001.A1	0000000425	2012-Dec-03 7:40
Radio Module 1	425-0003-001.1	0100000003	2012-Dec-03 14:10
Radio Module 2	425-0004-001.1	0200000015	2012-Dec-03 19:30
<b>SOFTWARE</b>			
SCD Firmware	5.00 (Oct 1 2012), Build: 4651		
Bootloader	6.3.0 (Sep 4 2014), Build: 6170		
Radio Driver	3.1.0 (Oct 08 2014), Build: 3750		
Software Version	7.1.0 (Oct 09 2014), Build: 5138		
DPI Signature File	navl_signatures-7.1.0.tar.gz		
License Key	13BR9-FFC48-LQWG2-2j6FE		
License Features	AOS 7.1 for 2 3x3 radios + RF Performance Manager + RF Analysis Manager + RF Security Manager + Application Control + Public Safety Band + 802.11ac + 802.11n		
<b>OPERATING STATUS</b>			
Time This Boot	Fri 2014-Oct-10 19:33:24 GMT		
Time Last Boot	Fri 2014-Oct-10 19:32:07 GMT		

Figure 227. AP Information

3. If you need to run a different software release, first log in to your account at [support.riverbed.com](http://support.riverbed.com). Download the desired FIPS-certified software image (see the [Note on page 609](#)). Click **Tools > System Tools** in the menu on the left of the WMI window. Follow the directions in [Step — System Upgrade](#) under “System” on [page 414](#).
4. Click **Configuration > Security** in the menu on the left of the WMI window. Then click **Management Control**. In the **Management Modes** section, set **FIPS 140-2, Level 2 Security** to **On**. ([Figure 228](#)) The AP will change the required settings, then reboot.



The screenshot displays the configuration page for a wireless access point, specifically the Security - Management Control window. The left sidebar contains a navigation menu with the following items: Status, Array, Network, RF Monitor, Stations, Statistics, Application Control, System Log, IDS Event Log, Configuration, Express Setup, Network, Services, VLANs, Tunnels, Security, Admin Management, Admin Privileges, Admin RADIUS, Management Control (highlighted), Access Control List, Global Settings, External Radius, Internal Radius, Active Directory, Rogue Control List, Oauth 2.0 Management, SSIDs, Groups, IAPs, WDS, Filters, and Clusters. The main content area is divided into several sections: Pre-login Banner, Post-login Banner, Management Transports, and Management Modes. The Pre-login Banner section includes fields for Maximum login attempts allowed (1 - 255) set to 3, Failed login retry period (0 - 65535 seconds) set to 0, and a Pre-login Banner field with a Submit button. The Post-login Banner section includes a similar field with a Submit button. The Management Transports section includes radio button options for SSH (On), Telnet (Off), Xircon (On), and Console (On). The Management Modes section includes radio button options for Network Assurance (On), PCI Audit Mode (Off), FIPS 140-2, Level 2 Security (On), and Spanning Tree Protocol (Enable). The FIPS 140-2, Level 2 Security option is highlighted with an orange box.

Figure 228. Security - Management Control Window

5. You may now proceed to define SSIDs, as described in “SSIDs” on page 274.

## To implement FIPS 140-2, Level 2 using CLI:

For details of the settings that are enforced for FIPS Level 2, see “About FIPS Configuration” on page 615.



*The following steps must be performed in the order shown—you must enable FIPS 140-2 before you create SSIDs. Otherwise, FIPS mode will change the PSK keys of SSIDs, and you will not know what the keys are.*

1. Use the following command to check that the System Software version running on the unit is one that has been certified for FIPS (see the [Note on page 609](#)).

```
AP# show system-info
```

If necessary, upgrade the AP to a certified release. (See [Step 3](#) in the previous procedure.)

2. The following CLI commands will perform all of the settings required to put the AP in FIPS mode.

```
AP# config
AP(config)# management
AP(config-mgmt)# fips on
```

3. You may now proceed to define SSIDs, as described in “[SSIDs](#)” on [page 274](#).
4. Use the **fips off** command if you wish to stop enforcing FIPS security requirements on the AP.

```
AP(config-mgmt)# fips off
```

## To check if AP is in FIPS mode:

You may determine whether or not the AP is running in FIPS mode.

- In the WMI, open the **Security > Management Control** page and view the **FIPS 140-2, Level 2 Security** setting.

- In the CLI, enter **show management** and check the **FIPS 140-2 Mode** setting.

### *See Also*

[The Windows Management Interface](#)

[The Command Line Interface](#)

## About FIPS Configuration

When you put the AP in FIPS mode, it checks that the following settings are in effect, and changes them as needed.

1. Telnet is disabled. See [“Management Control”](#) on page 243.
2. SSH is enabled. See [“Management Control”](#) on page 243.
3. SNMP (v1/v2/v3) is disabled. See [“SNMP”](#) on page 201.
4. Xircon is disabled. See [“Management Control”](#) on page 243.
5. XMS-Cloud management is disabled. See [“management”](#) on page 483.
6. Management over IAP is disabled. See [“Global Settings”](#) on page 325.
7. Fast roaming is disabled. See [“Global Settings”](#) on page 325.
8. RADIUS administrator authentication is disabled. See [“Admin RADIUS”](#) on page 240.
9. Global security settings: AES is enabled, TKIP is disabled, PSK is enabled, EAP is disabled, WPA Pre-Shared Key is set to the FIPS default hex value: 0123456789abcdef0123456789abcdef0123456789abcdef0123456789abcdef  
See [“Global Settings”](#) on page 255.
10. SSID security settings: Encryption is set to WPA2, AES is enabled, TKIP is disabled, PSK is enabled, EAP is disabled, WPA Pre-Shared Key is set to the FIPS default hex value: 0123456789abcdef0123456789abcdef0123456789abcdef0123456789abcdef  
See [“SSID Management”](#) on page 283.

11. These additional features are not allowed in FIPS mode: FTP, TFTP, and zero-touch activation. Only FIPS approved ciphers are used for SSH/HTTPS in FIPS mode.
12. When FIPS mode is enabled/disabled, CSPs (critical security parameters) are zeroed, configuration is saved and the system is rebooted.

# Glossary of Terms

## 802.11a

A supplement to the IEEE 802.11 WLAN specification that describes radio transmissions at a frequency of 5 GHz and data rates of up to 54 Mbps.

## 802.11ac

A supplement to the IEEE 802.11 WLAN specification. Operates in the 5 GHz range, using a number of advanced techniques to achieve a maximum speed of 1.3 Gbps. These techniques include improvements on the methods used for 802.11n, below.

## 802.11b

A supplement to the IEEE 802.11 WLAN specification that describes radio transmissions at a frequency of 2.4 GHz and data rates of up to 11 Mbps.

## 802.11d

A supplement to the Media Access Control (MAC) layer in 802.11 to promote worldwide use of 802.11 WLANs. It allows Access Points to communicate information on the permissible radio channels with acceptable power levels for user devices. Because the 802.11 standards cannot legally operate in some countries, 802.11d adds features and restrictions to allow WLANs to operate within the rules of these countries.

## 802.11g

A supplement to the IEEE 802.11 WLAN specification that describes radio transmissions at a frequency of 2.4 GHz and data rates of up to 54 Mbps.

## 802.11n

A supplement to the IEEE 802.11 WLAN specification that describes enhancements to 802.11a/b/g to greatly enhance reach, speed, and capacity.

## 802.1Q

An IEEE standard for MAC layer [frame tagging](#) (also known as encapsulation). Frame tagging uniquely assigns a user-defined ID to each frame. It also enables a switch to communicate [VLAN](#) membership information across multiple (and multi-vendor) devices by frame tagging.

## **AES**

(Advanced Encryption Standard) A data encryption scheme that uses three different key sizes (128-bit, 192-bit, and 256-bit). AES was adopted by the U.S. government in 2002 as the encryption standard for protecting sensitive but unclassified electronic data.

## **authentication**

The process that a station, device, or user employs to announce its identify to the network which validates it. IEEE 802.11 specifies two forms of authentication, open system and shared key.

## **bandwidth**

Specifies the amount of the frequency spectrum that is usable for data transfer. In other words, it identifies the maximum data rate a signal can attain on the medium without encountering significant attenuation (loss of power).

## **beacon interval**

When a device in a wireless network sends a beacon, it includes with it a beacon interval, which specifies the period of time before it will send the beacon again. The interval tells receiving devices on the network how long they can wait in low power mode before waking up to handle the beacon. Network administrators can adjust the beacon interval—usually measured in milliseconds (ms) or its equivalent, kilo-microseconds (Kmsec).

## **bit rate**

The transmission rate of binary symbols ('0' and '1'), equal to the total number of bits transmitted in one second.

## **BSS**

(Basic Service Set) When a WLAN is operating in infrastructure mode, each access point and its connected devices are called the Basic Service Set.

## **BSSID**

The unique identifier for an access point in a **BSS** network. See also, **SSID**.

### CDP

(Cisco Discovery Protocol) CDP is a layer 2 network protocol which runs on most Cisco equipment and some other network equipment. It is used to share information with other directly connected network devices. Information such as the model, network capabilities, and IP address is shared. Wireless APs can both advertise their presence by sending CDP announcements, and gather and display information sent by neighbors.

### cell

The basic geographical unit of a cellular communications system. Service coverage of a given area is based on an interlocking network of cells, each with a radio base station (transmitter/receiver) at its center. The size of each cell is determined by the terrain and forecasted number of users.

### channel

A specific portion of the radio spectrum—the channels allotted to one of the wireless networking protocols. For example, [802.11ac](#) and [802.11g](#) use 14 channels in the 2.4 GHz band, only 3 of which don't overlap (1, 6, and 11).

### CoS

(Class of Service) A category based on the type of user, type of application, or some other criteria that [QoS](#) systems can use to provide differentiated classes of service.

### default gateway

The gateway in a network that a computer will use to access another network if a gateway is not specified for use. In a network using subnets, a default gateway is the router that forwards traffic to a destination outside of the subnet of the transmitting device.

### DHCP

(Dynamic Host Configuration Protocol) A method for dynamically assigning IP addresses to devices on a network. DHCP issues IP addresses automatically within a specified range to client devices when they are first powered up.

### DHCP lease

The DHCP lease is the amount of time that the DHCP server grants to the DHCP client for permission to use a particular IP address. A typical DHCP server allows its administrator to set the lease time.

## DNS

(Domain Name System) A system that maps meaningful domain names with complex numeric IP addresses. DNS is actually a separate network—if one DNS server cannot translate a domain name, it will ask a second or third until a server is found with the correct IP address.

## domain

The main name/Internet address of a user's Internet site as registered with the InterNIC organization, which handles domain registration on the Internet. For example, the “domain” address for Google is: `http://www.google.com`, broken down as follows:

- **http://** represents the Hyper Text Teleprocessing Protocol used by all Web pages.
- **www** is a reference to the World Wide Web.
- **google** refers to the company.
- **com** specifies that the domain belongs to a commercial enterprise.

## DTIM

(Delivery Traffic Indication Message) A DTIM is a signal sent as part of a beacon by an access point to a client device in sleep mode, alerting the device to a packet awaiting delivery.

## EAP

(Extensible Authentication Protocol) When you log on to the Internet, you're most likely establishing a PPP connection via a remote access server. The password, key, or other device you use to prove that you are authorized to do so is controlled via PPP's Link Control Protocol (LCP). However, LCP is somewhat inflexible because it has to specify an authentication device early in the process. EAP allows the system to gather more information from the user before deciding which authenticator to use. It is called extensible because it allows more authenticator types than LCP (for example, passwords and public keys).



### **EDCF**

(Enhanced Distributed Coordinator Function) A **QoS** extension which uses the same contention-based access mechanism as current devices but adds “offset contention windows” that separate high priority **packets** from low priority packets (by assigning a larger random backoff window to lower priorities than to higher priorities). The result is “statistical priority,” where high-priority packets usually are transmitted before low-priority packets.

### **encapsulation**

A way of wrapping protocols such as TCP/IP, AppleTalk, and NetBEUI in Ethernet frames so they can traverse an Ethernet network and be unwrapped when they reach the destination computer.

### **encryption**

Any procedure used in cryptography to translate data into a form that can be decrypted and read only by its intended receiver.

### **Fast Ethernet**

A version of standard Ethernet that runs at 100 Mbps rather than 10 Mbps.

### **FCC**

(Federal Communications Commission) US wireless regulatory authority. The FCC was established by the Communications Act of 1934 and is charged with regulating Interstate and International communications by radio, television, wire, satellite and cable.

### **FIPS**

The **Federal Information Processing Standard (FIPS) Publication 140-2** establishes a computer security standard used to accredit cryptographic modules. The standard is a joint effort by the U.S. and Canadian governments.

### **frame**

A **packet** encapsulated to travel on a physical medium, like Ethernet or Wi-Fi. If a packet is like a shipping container, a frame is the boat on which the shipping container is loaded.

## Gigabit 1 through 4

The Gigabit Ethernet interfaces on XR Series APs. XR-4000 Series APs have two gigabit interfaces, while XR-6000 Series and higher models have four gigabit interfaces. See also, [Gigabit Ethernet](#).

## Gigabit Ethernet

A version of Ethernet with data transfer rates of 1 Gigabit (1,000 Mbps).

## Group

A user group, created to define a set of attributes (such as VLAN, traffic limits, and Web Page Redirect) and privileges (such as fast roaming) that apply to all users that are members of the group. This allows a uniform configuration to be easily applied to multiple user accounts. The attributes that can be configured for user groups are almost identical to those that can be configured for SSIDs.

## host name

The unique name that identifies a computer on a network. On the Internet, the host name is in the form **comp.xyz.net**. If there is only one Internet site the host name is the same as the [domain](#) name. One computer can have more than one host name if it hosts more than one Internet site (for example, **home.xyz.net** and **comp.xyz.net**). In this case, **comp** and **home** are the host names and **xyz.net** is the domain name.

## IPsec

A Layer 3 authentication and encryption protocol. Used to secure VPNs.

## LLDP

The Link Layer Discovery Protocol (LLDP) is a vendor-neutral link layer protocol used for advertising identities, capabilities, and neighbors on an IEEE 802 local area network

## MAC address

(Media Access Control Address) A 6-byte hexadecimal address assigned by a manufacturer to a device.

## Mbps

(Megabits per second) A standard measure for data transmission speeds (for example, the rate at which information travels over the Internet). 1 Mbps denotes one million bits per second.

### **MTU**

(Maximum Transmission Unit) The largest physical packet size—measured in bytes—that a network can transmit. Any messages larger than the MTU are divided into smaller **packets** before being sent. Every network has a different MTU, which is set by the network administrator. Ideally, you want the MTU to be the same as the smallest MTU of all the networks between your machine and a message's final destination. Otherwise, if your messages are larger than one of the intervening MTUs, they will get broken up (fragmented), which slows down transmission speeds.

### **NTP**

(Network Time Protocol) An Internet standard protocol (built on top of TCP/IP) that ensures the accurate synchronization (to the millisecond) of computer clock times in a network of computers. Running as a continuous background client program on a computer, NTP sends periodic time requests to servers, obtaining server time stamps and using them to adjust the client's clock.

### **packet**

Data sent over a network is broken down into many small pieces—packets—by the Transmission Control Protocol layer of TCP/IP. Each packet contains the address of its destination as well the data. Packets may be sent on any number of routes to their destination, where they are reassembled into the original data. This system is optimal for connectionless networks, such as the Internet, where there are no fixed connections between two locations.

### **PLCP**

(Physical Layer Convergence Protocol) Defined by IEEE 802.6, a protocol specified within the Transmission Convergence layer that defines exactly how cells are formatted within a data stream for a particular type of transmission facility.

### **PoE**

This refers to the optional Riverbed-supplied Power over Gigabit Ethernet modules that provide DC power to APs. Power is supplied over the same Cat 5e or Cat 6 cable that supplies the data connection to your gigabit Ethernet switch, thus eliminating the need to run a power cable.

### **preamble**

Preamble (sometimes called a header) is a section of data at the head of a **packet** that contains information that the access point and client devices need when sending and receiving packets. **PLCP** Has two structures, a long and a short preamble. All compliant 802.11b systems have to support the long preamble. The short preamble option is provided in the standard to improve the efficiency of a network's throughput when transmitting special data, such as voice, VoIP (Voice-over IP) and streaming video.

### **private key**

In cryptography, one of a pair of keys (one public and one private) that are created with the same algorithm for encrypting and decrypting messages and digital signatures. The private key is provided only to the requester and never shared. The requester uses the private key to decrypt text that has been encrypted with the public key by someone else.

### **PSK**

(Pre-Shared Key) A TKIP passphrase used to protect your network traffic in WPA.

### **public key**

In cryptography, one of a pair of keys (one public and one private) that are created with the same algorithm for encrypting and decrypting messages and digital signatures. The public key is made publicly available for encryption and decryption.

### **QoS**

(Quality of Service) QoS can be used to describe any number of ways in which a network provider prioritizes or guarantees a service's performance.

### **RADIUS**

(Remote Authentication Dial-In User Service) A client-server security protocol, developed to authenticate, authorize, and account for dial-up users. The RADIUS server stores user profiles, which include passwords and authorization attributes.

### **RSSI**

(Received Signal Strength Indicator) A measure of the energy observed by an antenna when receiving a signal.

### **SDMA**

(Spatial Division Multiple Access) A wireless communications mode that optimizes the use of the radio spectrum and minimizes cost by taking advantage of the directional properties of antennas. The antennas are highly directional, allowing duplicate frequencies to be used for multiple zones.

### **SNMP**

(Simple Network Management Protocol) A standard protocol that regulates network management over the Internet.

### **SNTP**

(Simple Network Time Protocol) A simplified version of NTP. SNTP can be used when the ultimate performance of the full NTP implementation described in RFC 1305 is not needed or justified.

### **SSH**

(Secure SHell) Developed by SSH Communications Security, Secure Shell is a program to log into another computer over a network, to execute commands in a remote machine, and to move files from one machine to another. The AP only allows SSH-2 connections. SSH-2 provides strong authentication and secure communications over insecure channels. SSH-2 protects a network from attacks, such as IP spoofing, IP source routing, and DNS spoofing. Attackers who has managed to take over a network can only force SSH to disconnect—they cannot “play back” the traffic or hijack the connection when encryption is enabled. When using SSH-2’s `slogin` (instead of `rlogin`) the entire login session, including transmission of password, is encrypted making it almost impossible for an outsider to collect passwords. Be aware that your SSH utility must be set up to use SSH-2.

### **SSID**

(Service Set Identifier) Every wireless network or network subset (such as a [BSS](#)) has a unique identifier called an SSID. Every device connected to that part of the network uses the same SSID to identify itself as part of the family—when it wants to gain access to the network or verify the origin of a data packet it is sending over the network. In short, it is the unique name shared among all devices in a WLAN.

### **subnet mask**

A mask used to determine what subnet an IP address belongs to. An IP address has two components: (1) the network address and (2) the host address. For example, consider the IP address 150.215.017.009. Assuming this is part of a Class B network, the first two numbers (150.215) represent the Class B network address, and the second two numbers (017.009) identify a particular host on this network.

### **TKIP**

(Temporal Key Integrity Protocol) Provides improved data encryption by scrambling the keys using a hashing algorithm and, by adding an integrity-checking feature, ensures that the encryption keys haven't been tampered with.

### **transmit power**

The amount of power used by a radio transceiver to send the signal out. Transmit power is generally measured in milliwatts, which you can convert to dBm.

### **User group**

See [Group](#).

### **VLAN**

(Virtual LAN) A group of devices that communicate as a single network, even though they are physically located on different LAN segments. Because VLANs are based on logical rather than physical connections, they are extremely flexible. A device that is moved to another location can remain on the same VLAN without any hardware reconfiguration.

### **VLAN tagging**

(Virtual LAN tagging) Static port-based VLANs were originally the only way to segment a network without using routing, but these port-based VLANs could only be implemented on a single switch (or switches) cabled together. Routing was required to transfer traffic between unconnected switches. As an alternative to routing, some vendors created proprietary schemes for sharing VLAN information across switches. These methods would only operate on that vendor's equipment and were not an acceptable way to implement VLANs. With the adoption of the [802.11n](#) standard, traffic can be confined to VLANs that exist on

multiple switches from different vendors. This interoperability and traffic containment across different switches is the result of a switch's ability to use and recognize 802.1Q tag headers—called VLAN tagging. Switches that implement 802.1Q tagging add this tag header to the frame directly after the destination and source MAC addresses. The tag header indicates:

1. That the packet has a tag.
2. Whether the packet should have priority over other packets.
3. Which VLAN it belongs to, so that the switch can forward or filter it correctly.

### **WDS (Wireless Distribution System)**

WDS creates wireless backhauls between APs. These links between APs may be used rather than having to install data cabling to each AP.

### **WEP**

(Wired Equivalent Privacy) An optional IEEE 802.11 function that offers frame transmission privacy similar to a wired network. The Wired Equivalent Privacy generates secret shared encryption keys that both source and destination stations can use to alter frame bits to avoid disclosure to eavesdroppers.

### **Wi-Fi Alliance**

A nonprofit international association formed in 1999 to certify interoperability of wireless Local Area Network products based on IEEE 802.11 specification. The goal of the Wi-Fi Alliance's members is to enhance the user experience through product interoperability.

### **Wireless AP**

A high capacity wireless networking device consisting of multiple radios arranged in a circular AP.

### **WPA**

(Wi-Fi Protected Access) A Wi-Fi Alliance standard that contains a subset of the IEEE 802.11i standard, using TKIP as an encryption method and 802.1x for authentication.

## **WPA2**

(Wi-Fi Protected Access 2) WPA2 is the follow-on security method to WPA for wireless networks and provides stronger data protection and network access control. It offers Enterprise and consumer Wi-Fi users with a high level of assurance that only authorized users can access their wireless networks. Like WPA, WPA2 is designed to secure all versions of 802.11 devices, including 802.11a, 802.11b, 802.11g, and 802.11n, multi-band and multi-mode.

## **Xirrus Management System (XMS)**

A Xirrus product used for managing large Wireless AP deployments from a centralized Web-based interface.

Riverbed Release 8.5 10/17/18



# Index

## Numerics

11ac  
    see 802.11ac 356  
2.5 gigabit 176  
40MHz  
    auto bond 354  
802.11a 3, 4, 319, 341  
802.11a/b/g 36  
802.11a/b/g/n 22  
802.11a/n 22, 76, 283  
802.11ac  
    WMI page 356  
802.11b 3, 4, 347  
802.11b/g 319, 347  
802.11b/g/n 22, 76, 283  
802.11e 24  
802.11g 3, 4, 347  
802.11i 4, 84, 167  
802.11n 4  
    WMI page 353  
802.11p 24  
802.11q 24  
802.1x 4, 60, 70, 84, 167, 534  
80MHz  
    auto bond 357

**A**  
abg(n)  
    nomenclature 2  
abg(n)2  
    intrusion detection 382  
    self-monitoring  
        radio assurance (loopback mode) 365, 366  
Access Control List 230, 534  
access control lists (ACLs) 253, 305

Access Point 167  
Access Points, XR  
    overview 4  
access points, XR 1  
account, user 266  
ACLs 60, 230, 534  
active directory 266  
active IAPs  
    per SSID 304  
active software image 416  
Address Resolution Protocol  
    window 114  
Address Resolution Protocol (ARP)  
    338  
Admin 534  
Admin ID 236  
    authentication via RADIUS 240  
Admin Management 236  
admin privileges  
    setting in admin RADIUS account 240  
admin RADIUS account  
    if using Console port 240  
admin RADIUS authentication 240  
administration 84, 167, 230  
Administrator Account 528  
Advanced Encryption Standard 60, 534  
Advanced RF Analysis Manager  
    see RAM 27  
Advanced RF Performance Manager  
    see RPM 25  
Advanced RF Security Manager  
    see RSM 26  
AeroScout  
    see WiFi tag 194  
AES 4, 24, 60, 70, 84, 167, 526, 534  
AirWatch 407  
Airwatch  
    CLI command 485

- allow traffic
    - see filters 398
  - Analysis Manager
    - see RAM 27
  - API Documentation 429
  - appearance
    - WMI options 434
  - application control
    - custom list 405, 406
    - update (signature file) 422
  - approved
    - setting rogues 124
  - APs 70, 124, 270, 271, 534
    - rogues, blocking 381
  - APs, rogue
    - see rogue APs 364, 382
  - APs, XR
    - overview 4
  - ARP filtering 338
  - ARP table window 114
  - Array 38, 76, 91, 167, 174
    - connecting 76
    - dismounting 76
    - management 411
    - mounting 76
    - powering up 76
    - securing 76
    - Web Management Interface 91
    - XR-2000 Series 14, 15
    - XR-2005 Series 14, 15
  - ArrayOS
    - upgrade 415
  - Arrays, XR 1
    - overview 4
  - associated users 38
  - assurance
    - network server connectivity 117, 248
  - assurance (radio loopback testing) 364
  - assurance, station
    - see station assurance 371
  - attack (DoS)
    - see DoS attack 384
  - attack (impersonation)
    - see impersonation attack 385
  - auth CLI command 456
  - authentication 24, 266
    - of admin via RADIUS 240
  - authentication (Oauth token)
    - CLI command
      - auth 456
  - authority
    - certificate 234, 250
  - auto block
    - rogue APs, settings 382
  - auto bond
    - 40MHz 354
    - 80MHz 357
  - Auto Cell
    - by band for 5G 344, 349
    - by channel for 5G 344, 349
    - monitor mode 344, 350
  - auto negotiate 174
  - auto-blocking
    - rogue APs 381
  - auto-configuration 84, 325, 341, 347
    - channel and cell size 364
  - automatic refresh
    - setting interval 434
  - automatic update from remote server
    - configuration files, boot image 416
- ## B
- backhaul
    - see WDS 67
  - backup unit
    - see standby mode 365
  - band association 283
  - beacon
    - bluetooth iBeacon 457

- beacon interval 325
- Beacon World Mode 325
- beam distribution 22
- benefits 22
- BLE
  - bluetooth 457
- block
  - rogue APs, settings 379
- block (rogue APs)
  - see auto block 382
- blocking
  - rogue APs 381
- blocking rogue APs 364
- bluetooth
  - iBeacon 457
- bond
  - mode, bridging 177
- boot 416
- bridging APs 177
- broadcast 339
  - fast roaming 339
- browser
  - certificate error 234, 250
- BSS 532
- BSSID 124, 532
- buttons 96
- BYOD (Bring Your Own Device) 287

**C**

- capacity
  - of 802.11n 54
- captive portal
  - Facebook Wi-Fi 500
  - HTTPS pass-through 500
- cascading style sheet
  - sample for web page redirect 425
- CDP 458
- CDP (Cisco Discovery Protocol)
  - settings 185
- cdp CLI command 458

- CDP neighbors 116
- cell
  - sharp cell 364
- cell size 38, 319
  - auto-configuration 364
- cell size configuration 364
- certificate
  - about 234, 250
  - authority 234, 250
  - error 234, 250
  - install Xirrus authority 250
  - X.509 234, 250
- chain
  - see bridging 177
- channel
  - auto-configuration 364
  - configuration 364
  - list selection 364
- channels 38, 124, 319, 325, 341, 347
  - non-overlapping 23
- CHAP (Challenge-Handshake Authentication Protocol)
  - Admin RADIUS settings 241
  - web page redirect 295
- CHAP Challenge Handshake Authentication Protocol)
  - RADIUS ping 426
- character restrictions 98
- Chrome 34
- Cisco Discovery Protocol
  - see cdp 458
- Cisco Discovery Protocol (CDP) 185
- CLI 4, 70, 73, 79, 80, 437
  - executing from WMI 427
  - vs. XMS 89
- CLI commands
  - see commands 458
- CLI management
  - IPv6 90
- client

- web page redirect 424
- Cloud
  - Personal Wi-Fi 296, 308
  - WPR 296
- cluster
  - CLI command 461
- command
  - wifi-tag 505
- Command Line Interface 4, 66, 73, 76, 79, 80, 437, 534
  - configuration commands 454
  - getting help 439
  - getting started 439
  - inputting commands 439
  - sample configuration tasks 506
  - SSH 437
  - top level commands 442
- command, utilities
  - ping, traceroute, RADIUS ping 425
- commands
  - acl 454
  - admin 455
  - auth, authentication 456
  - cdp 458
  - clear 459
  - cluster 461
  - configure 443
  - contact-info 463
  - date-time 464
  - device-id 465
  - dhcp-server 466
  - dns 467
  - file 468
  - filter 472
  - group 461, 476
  - hostname 476
  - interface 477
  - load 480
  - location 480
  - location-reporting 481, 494
  - management 483
  - mdm (mobile device management)
    - Airwatch 485
  - more 486
  - netflow 487
  - no 488
  - quit 490
  - radius-server 489, 490
  - reboot 492, 503
  - reset 492
  - restore 493
  - run-tests 495
  - security 497
  - show 447
  - snmp 498
  - ssid 499
  - statistics 452
  - syslog 501
  - tunnel 502
  - vlan 504
- Community String 525
- compass heading 104
- configuration 165, 534
  - express setup 167
  - reset to factory defaults 420
- configuration changes
  - applying 98
- configuration files
  - automatic update from remote server 416
  - download 418
  - update from local file 418
  - update from remote file 418
- connection
  - tracking window 115
- connectivity
  - servers, see network assurance 117, 248
- Console port
  - login via 240

- coverage 38, 73
  - extended 22
- coverage patterns 4
- critical messages 94
- CTS/RTS 341, 347
- custom application control list 405, 406

## D

- daisy chain
  - see bridging 177
- data rate 341, 347
- date/time restrictions
  - and interactions 315
- default gateway 84, 174
- default settings 523
- Default Value 526
  - DHCP 525
- defaults
  - reset configuration to factory defaults 420
- Delivery Traffic Indication Message 325
- denial of service
  - see DoS attack 384
- deny traffic
  - see filters 398
- deployment 36, 66, 70, 73, 534
- detection
  - intrusion 382
    - see DoS attack 384
    - see impersonation attack 385
    - see impersonation detection 384
    - see intrusion detection 384, 385
- device management
  - see Mobile Device Management 407
- DHCP 38, 79, 80, 84, 167, 174, 524
  - default settings 525
  - leases window 115
- DHCP Server 189

- diagnostics
  - log, create file 421
- directory, active 266
- Discovery Protocol
  - Cisco (CDP) 185
  - Link Layer 186
- display
  - WMI options 434
- DNS 84, 167, 184
- DNS domain 184
- DNS server 184
- documentation, API 429
- Domain Name System 184
- DoS attack detection
  - settings 384
- DTIM 325
- DTIM period 325
- duplex 174
- dynamic VLAN
  - overridden by group 313

## E

- EAP 526, 534
- EAP-MDS 24
- EAP-PEAP 534
- EAP-TLS 24, 60, 534
- EAP-TTLS 24, 60, 534
- EasyPass Onboarding
  - User-PSK 287
- EDCF 325
- Encryption 526, 534
- encryption 24
- encryption method
  - recommended (WPA2 with AES) 232
  - setting 233
  - support of multiple methods 232
- encryption method (encryption mode)
  - Open, WEP, WPA, WPA2, WPA-Both 232

- encryption standard
    - AES, TKIP, both 232
    - setting 233
  - Enterprise 1, 3, 534
    - WLAN 3
  - Enterprise Class Management 4
  - Enterprise Class Security 4
  - ESS 532
  - ESSID 532
  - Ethernet 73, 76, 79, 80, 84, 167
    - 2.5 gigabit 176
  - Euclid
    - location service
      - data format 545
  - event log
    - IDS (intrusion detection) 162
    - see system log 154
  - event messages 94
  - Express Setup 76, 84, 167
  - express setup 84, 167
  - Extended Service Set 532
  - Extensible Authentication Protocol 534
- F**
- Facebook Wi-Fi
    - HTTPS pass-through 500
  - factory default settings 523
  - factory defaults 524, 525, 526, 528
    - DHCP 525
    - reset configuration to 418
  - factory.conf 418
  - fail-over
    - standby mode 365
  - failover 56, 70
  - FAQs 532
  - Fast Ethernet 73, 79, 80, 167, 174, 523
  - fast roaming 24, 111, 339
    - about 318
    - and VLANs 318
  - features 22, 66, 174, 193, 197, 325, 534
    - and license key 84, 414
  - Federal Information Processing Standard (FIPS)
    - see FIPS 609
  - feedback 96
  - filter list 399
  - filter name 400
  - filtering
    - IPv6 339
  - filters 398, 399, 400
    - custom application control list 405, 406
    - stateful filtering, disabling 399
    - statistics 151
  - FIPS 249
  - FIPS 140-2 Security 609
  - Firefox 34
  - firewall 398
    - and port usage 62
    - stateful filtering, disabling 399
  - fragmentation threshold 341, 347
  - frequently asked questions 532
  - FTP 534
- G**
- General Hints 531
  - getting started
    - express setup 167
  - Gigabit 73, 79, 80, 84, 167, 174, 523
  - global settings 325, 341, 347
  - glossary of terms 617
  - Google Chrome 34
  - Group
    - management 312
  - group 310
    - CLI command 461, 476
    - VLAN overrides dynamic VLAN 313
  - group limits and interactions 315
  - Group Rekey 526

Guest Access  
WPR 296

GUI  
see WMI 434

## H

heading, compass 104  
help 96  
button, bottom of page 96  
button, left frame 94

Help button 91

honeypot 306

honeypot SSID  
whitelist settings 307

host name 84, 91, 167, 184

hs.css 425

HTTPS  
certificate, see certificate 250

HTTPS pass-through  
Facebook Wi-Fi 500

HTTPS port  
web page redirect 293, 303

HyperTerminal 34, 73

## I

IAP 38, 76, 167, 319  
active SSIDs 304  
naming 2  
see also radio 317  
settings 319

IAP LED 76

iBeacon  
bluetooth 457

IDS  
see Intrusion Detection 378

IDS event log  
viewing window 162

IEEE 3, 84, 167

IEEE 802.11ac  
WMI page 356

IEEE 802.11n  
capacity, increased 54  
multiple data streams 48  
spatial multiplexing 48  
WMI page 353

IEEE 802.1Q 537

image  
active software image 416  
upgrade software image 415

impersonation attack detection  
settings 385

installation 33, 71, 76  
installing the MCAP-3616 73  
mounting the unit 76  
requirements 33  
workflow 71

installation workflow 71

interfaces 167

Web 89

internal login page  
web page redirect 294  
web page redirect, customize 298

internal splash page  
web page redirect 294  
web page redirect, customize 298

Internet Explorer 34

interval  
automatic WMI refresh 434

intrusion detection 124, 382  
and auto block settings 382  
configuration 364  
setting as approved or known 124

intrusion detection (IDS)  
viewing event log 162

Intrusion Detection (IDS/IPS) 378

IP Address 38, 84, 91, 97, 124, 167, 174,  
184, 197, 201, 411, 524

IP Subnet Mask 84

IPS  
see Intrusion Detection 378

IPv6 4  
 filtering 339  
 for CLI or WMI management 90  
 in CLI 439

## K

key  
 upgrade 84, 414  
 key features 22  
 Keyboard Shortcuts 529  
 keyboard shortcuts 529  
 known  
 setting rogues 124

## L

lastboot.conf 418  
 Layer 3  
 fast roaming 318  
 LDAP 266  
 lease 524  
 Lease Time 524  
 leases, DHCP  
 viewing 115  
 LEDs 76  
 sequence 76  
 settings 385  
 license Key  
 upgrading 84, 414  
 limits  
 group 315  
 interactions 315  
 station 315  
 traffic 315  
 Link Layer Discovery Protocol (LLDP)  
 186  
 list  
 custom application control list 405,  
 406  
 list, access control  
 see access control list 253, 305

list, MAC access  
 see access control list 253  
 list, SSID access  
 see access control list 305  
 LLDP (Link Layer Discovery Protocol)  
 settings 186  
 LLDP List 117  
 local management vs. XMS 89  
 location  
 CLI command  
 location-reporting 481, 494  
 location information 84, 91, 167  
 location service  
 data formats 545  
 lock, WDS  
 for management system 394, 478  
 log  
 diagnostics, create file 421  
 log messages  
 counters 95  
 log, IDS (intrusion detection)  
 viewing window 162  
 log, system (event)  
 viewing window 154  
 logging in 79, 80, 97  
 Login 97  
 login  
 via Console port 240  
 login page  
 web page redirect 294, 424  
 web page redirect, customize 298  
 logout 435  
 long retry limit 325  
 loopback  
 see radio assurance 518  
 loopback testing  
 radio assurance mode 364

## M

MAC 60, 79, 80, 532, 534



- MAC Access Control Lists 60
- MAC Access List 253
- MAC address 253, 532, 534
- Management 528, 534
- management 99, 165, 411
  - IPv4 or IPv6 90
  - local vs. XMS 89
  - of Arrays 411
  - Web Management Interface (WMI) 89
- management (XMS) 24
- maximum lease 524
- Maximum Lease Time 524
- MDM
  - see Mobile Device Management 407
- Megabit 84
- Message Integrity Check 534
- messages
  - syslog counters 95
- MIC 24, 534
- Mobile Device Management
  - AirWatch 407
- mobile device management
  - Airwatch (CLI command) 485
- Mobile Device Management (MDM) 407
- monitor
  - mode for Auto Cell 344, 350
- monitor, RF 365
- monitoring
  - intrusion detection 124
  - see intrusion detection 382
- mounting 76
- mounting plate 76
- mounting the unit 76
- MTU 174
  - size 174
- multiple data streams 48

## N

- NAT
  - table - see connection tracking 115
- neighbors, CDP 116
- neighbors, LLDP 117
- Netflow 193
- netflow
  - CLI command 487
- network
  - interfaces 173
  - settings 174
- network assurance 117, 248
- network connections 73, 97, 534
- network installation 33
- network interface ports 79, 80
- network interfaces 174, 523
- network status
  - ARP table window 114
  - connection
    - tracking window 115
  - routing table window 114
  - viewing leases 115
- Network Time Protocol 84, 167, 190
- network tools
  - ping, traceroute, RADIUS ping 425
- nomenclature 2
- non-overlapping channels 23
- north
  - see compass heading 104
- NTP 84, 167, 190, 524
- NTP Server 190

## O

- Oauth
  - CLI command
    - auth 456
- Onboarding
  - EasyPass, User-PSK 287
- Open (encryption method) 232
- optimization, VLAN 339

- options
    - WMI [434](#)
  - orientation
    - see compass heading [104](#)
  - overview [4](#)
- P**
- PAP (Password Authentication Protocol)
    - Admin RADIUS settings [241](#)
    - RADIUS ping [426](#)
    - web page redirect [295](#)
  - passphrase [60](#), [84](#), [167](#)
  - pass-through, HTTPS
    - Facebook Wi-Fi [500](#)
  - pass-thru
    - see pass-through [500](#)
  - passthru
    - see pass-through [500](#)
  - Password [528](#), [534](#)
  - password [97](#)
  - Payment Card Industry Data Security Standard
    - see PCI DSS [603](#)
  - PCI audit [248](#)
  - PCI DSS [603](#)
  - PEAP [24](#), [394](#)
  - Performance Manager
    - see RPM [25](#)
  - Personal Wi-Fi [308](#)
    - WPR [296](#)
  - Ping [411](#)
  - ping [425](#)
  - planning [56](#), [59](#), [60](#), [66](#)
    - failover [56](#)
    - network management [66](#)
    - port failover [56](#)
    - power [59](#)
    - security [60](#)
    - switch failover [56](#)
    - WDS [67](#)
  - PoGE [33](#)
  - PoGE Power Injectors [1](#)
  - port failover [56](#)
  - port requirements [62](#)
  - power
    - request power (LLDP) [187](#)
  - power outlet [33](#)
  - Power over Gigabit Ethernet [2](#), [33](#), [59](#), [73](#)
  - power planning [59](#)
  - pre-shared key [60](#), [70](#), [534](#)
  - Print button [91](#)
  - probe
    - see Netflow [193](#)
  - product installation [33](#)
  - product overview [4](#)
  - product specifications [31](#)
  - PSK [70](#), [526](#)
    - User-PSK, EasyPass Onboarding [287](#)
  - PuTTY [33](#), [66](#), [84](#), [167](#), [534](#)
  - PuTTY [34](#)
- Q**
- QoS [24](#), [283](#), [526](#), [532](#), [624](#)
    - conflicting values [280](#)
    - levels defined [285](#), [313](#)
    - priority [283](#)
    - SSID [276](#), [285](#)
      - about setting QoS [532](#), [533](#)
      - default QoS [526](#)
      - user group [313](#)
  - quality
    - of user experience [371](#)
  - Quality of Service [24](#)
    - see QoS [285](#), [313](#)
  - quick reference guide [523](#)
  - quick start
    - express setup [167](#)

## R

- radio 84, 167, 341, 347, 385
  - assurance (self-test) 365, 366
  - fast roaming 318
  - Intrusion Detection (IDS/IPS) 378
- radio assurance (loopback testing) 364
- radio assurance (loopback) mode 365, 366
- radio LED 385
- radio LED settings 385
- radios
  - auto block rogues 382
  - intrusion detection 382
  - naming 2
- RADIUS 4, 33, 60, 70, 230, 253, 305, 524, 534
  - admin authentication 240
  - setting admin privileges 240
  - setting user VSAs 260
  - Vendor Specific Attributes (VSAs) 544
- RADIUS ping
  - CHAP Challenge Handshake Authentication Protocol) 426
  - PAP (Password Authentication Protocol) 426
- RADIUS Ping command 425
- RADIUS Server 524
- RADIUS settings
  - web page redirect 295
- RAM (RF Analysis Manager) 27
- reauthentication 325
- reboot 416
  - active software image 416
- redirect (WPR) 424
- refresh interval
  - WMI 434
- remote boot image
  - automatic update from remote TFTP server 416
- remote configuration
  - automatic update from remote server 416
- remote TFTP server
  - automatic update of boot image, configuration 416
- rename
  - SSID 291
- request power (LLDP)
  - LLDP
  - request power 187
- Reset 411, 524
- reset configuration
  - to factory defaults 420
- restore command 493
- restrictions
  - date/time 315
  - stations 315
  - traffic 315
- RF
  - intrusion detection 364
  - spectrum management 364
- RF Analysis Manager
  - see RAM 27
- RF configuration 364
- RF management
  - see channel 364
- RF monitor 365
- RF monitor mode
  - for Auto Cell 344, 350
- RF Performance Manager
  - see RPM 25
- RF resilience 364
- RF Security Manager
  - see RSM 26
- roaming 24, 111, 339
  - see fast roaming 318
- Rogue AP 4, 66, 124, 270, 271, 534
- rogue AP
  - blocking 381

- settings for blocking 379
  - Rogue AP List 124
  - rogue APs
    - auto block settings 382
    - blocking 364
  - Rogue Control List 270, 271
  - rogue detection 22
  - rogues
    - setting as known or approved 124
  - root command prompt 442
  - route
    - trace route utility 425
  - routing table window 114
  - RPM (RF Performance Manager) 25
  - RSM (RF Security Manager) 26
  - RSSI 124
  - RTS 341, 347
  - RTS threshold 341, 347
- S**
- Safari 34
  - sample Perl and CSS files for 424
  - save
    - with reboot 416
  - Save button 91
  - saved.conf 418
  - scalability 3
  - schedule
    - auto channel configuration 364
  - scheduling
    - SSID 291
  - Secondary Port 524
  - Secondary Server 524
  - secret 524
  - Secure Shell 34
  - secure Shell 33
  - Security
    - FIPS 609
    - PCI DSS 603
  - security 4, 24, 230, 532, 534
    - certificate, see certificate 250
  - Security Manager
    - see RSM 26
  - see group 310
  - self-monitoring 382
    - radio assurance 518
    - radio assurance options 365, 366
  - self-test
    - radio assurance mode 365, 366
  - serial port 34, 79, 80, 534
  - server, VTun
    - see VTun 224
  - servers
    - connectivity, see network assurance 117, 248
  - Service Set Identifier 84
  - Services 189, 532
  - settings 167
  - setup, express 167
  - sharp cell 364
    - setting in WMI 368
  - short retry limit 325
  - signal processing
    - MIMO 48
  - signature file
    - update (application control) 422
  - SNMP 4, 20, 84, 167, 174, 189, 201, 525
    - required for XMS 202
  - software
    - upgrade license key 84, 414
  - software image
    - active software image 416
  - Software Upgrade 411
  - software upgrade 415
  - spatial multiplexing 48
  - specifications 31
  - spectrum (RF) management 364
  - speed 3, 79, 80, 174
    - 11 Mbps 3
    - 54 Mbps 3

- splash page
    - web page redirect 294, 424
    - web page redirect, customize 298
  - SSH 33, 34, 66, 84, 167, 174, 231, 528, 534
  - SSH-2 231
  - SSID 4, 84, 91, 124, 167, 271, 283, 526, 532, 537
    - about usage 532
    - active IAPs 304
    - honeypot 306
    - honeypot, whitelist 307
    - QoS 276, 285
      - about using 532, 533
    - QoS, about usage 532
    - rename 291
    - rogue control list 270
    - scheduling 291
    - web page redirect settings 289
    - web page redirect settings, about 293, 303
    - web page redirect settings, whitelist 299, 300
    - whitelist, honeypot 306
  - SSID Access List 305
  - SSID address 305
  - SSID Management 283, 526, 532
  - standby mode 365
  - stateful filtering
    - disabling 399
  - static IP 84, 167, 174
  - station
    - assurance 371
  - station assurance 371
  - station timeout period 325
  - Stations 532
  - stations
    - limits and interactions 315
    - rogues 124
    - statistics 151
    - statistics per station 153
  - statistics 167
    - filters 151
    - netflow 193
    - per-station 153
    - stations 151
    - WDS 148
  - status bar 91
  - submitting comments 96
  - subnet 33, 56, 84, 174
  - switch failover 56
  - synchronize 84, 167, 190
  - Syslog 84, 91, 167, 189, 197, 524
    - time-stamping 84
  - syslog messages
    - counters 95
  - Syslog reporting 197
  - Syslog Server 197
  - system commands
    - ping, trace route, RADIUS ping 425
  - System Configuration Reset 411
  - System Log 197
  - system log
    - viewing window 154
  - System Reboot 411
  - System Tools 411
  - system tools 412
- ## T
- tag, WiFi 194
  - TCP
    - port requirements 62
  - technical support
    - frequently asked questions 532
  - Telnet 231, 528, 534
  - Temporal Key Integrity Protocol 534
  - TFTP server
    - automatic update of boot image, configuration 416

- Time Out [524](#)
  - time zone [84](#), [167](#), [190](#)
  - timeout [325](#), [411](#)
  - Tips [531](#)
  - TKIP [24](#), [60](#), [70](#), [84](#), [167](#), [526](#), [534](#)
  - TKIP encryption
    - and XR Arrays [256](#)
  - token
    - CLI command
      - auth [456](#)
  - tool
    - ping, trace route, RADIUS ping [425](#)
  - Tools [411](#), [534](#)
  - tools, network [425](#)
  - tools, system [412](#)
  - trace route utility [425](#)
  - traffic
    - filtering [398](#)
    - limits and interactions [315](#)
  - transmit power [38](#)
  - Trap Host [525](#)
  - trap port [201](#), [525](#)
  - tunnel
    - CLI command [502](#)
  - tunneled
    - fast roaming [339](#)
  - Tunnels [225](#)
  - tunnels
    - see VTun [218](#), [224](#)
- U**
- UDP
    - port requirements [62](#)
  - unknown
    - setting rogues [124](#)
  - update
    - signature file (application control) [422](#)
  - upgrade
    - active software image [416](#)
    - license key [84](#), [414](#)
    - software image [415](#)
  - U-PSK, EasyPass Onboarding [287](#)
  - user accounts [266](#)
    - setting RADIUS VSAs [260](#)
  - user group [310](#)
    - QoS [313](#)
  - user group limits and interactions [315](#)
  - user interface [89](#)
  - User-PSK, EasyPass Onboarding [287](#)
  - utilities
    - ping, trace route, RADIUS ping [425](#)
  - utility buttons [96](#)
- V**
- Vendor Specific Attributes (VSAs)
    - RADIUS [544](#)
    - RADIUS, for Xirrus [544](#)
  - virtual tunnels
    - see VTun [224](#)
  - VLAN [4](#), [70](#), [283](#), [526](#), [532](#), [537](#)
    - broadcast optimization [339](#)
    - dynamic
      - overridden by group [313](#)
      - group (vs. dynamic VLAN) [313](#)
  - vlan
    - CLI command [504](#)
  - VLAN ID [283](#)
  - VLANs [217](#)
    - and fast roaming [318](#)
  - voice
    - fast roaming [318](#)
  - Voice-over IP [347](#)
  - VoIP [347](#)
  - VoWLAN [24](#)
  - VPN [84](#), [167](#), [534](#)
  - VTs
    - Virtual Tunnel Server [218](#), [224](#)

### VTun

- specifying tunnel server [218](#), [224](#)
- understanding [218](#)

## W

wall thickness considerations [36](#)

warning messages [94](#)

WDS [391](#), [394](#)

- about [67](#)
- long distance [323](#), [393](#)
- planning [67](#)
- statistics [148](#)
- timeouts [323](#), [393](#)

WDS Client Links [394](#)

WDS lock

- for management system [394](#), [478](#)

Web interface

- structure and navigation [94](#)

web interface [89](#)

Web Management Interface [66](#), [76](#), [79](#),  
[80](#), [97](#), [532](#)

Web Management Interface (WMI) [89](#)

web page redirect [424](#)

- also called WPR [424](#)
- CHAP (Challenge-Handshake Authentication Protocol) [295](#)
- customize internal login/splash page [298](#)
- Facebook Wi-Fi [500](#)
- HTTPS pass-through [500](#)
- HTTPS port [293](#), [303](#)
- install files for [424](#)
- internal login page [294](#)
- internal splash page [294](#)
- PAP, CHAP [295](#)
- RADIUS settings [295](#)
- remove files for [425](#)
- sample WPR files [425](#)
- SSID settings [289](#)
- SSID settings, about [293](#), [303](#)

whitelist settings, about [299](#), [300](#)

WEP [24](#), [60](#), [84](#), [167](#), [230](#), [283](#), [526](#), [534](#)

WEP (Wired Equivalent Privacy)  
encryption method [232](#)

WEP encryption

- and XR Arrays [257](#)

whitelist

- honeypot [306](#), [307](#)
- web page redirect [299](#), [300](#)

Wi-Fi

- personal [308](#)

Wi-Fi Protected Access [4](#), [60](#), [84](#), [167](#),  
[534](#)

WiFi tag [194](#)

wifi-tag

- CLI command [505](#)

Wired Equivalent Privacy [84](#), [534](#)

Wireless Distribution System [391](#)

wireless LAN [3](#)

wireless security [167](#)

WLAN [167](#)

WMI [4](#), [66](#), [70](#), [79](#), [80](#), [89](#), [319](#)

- appearance options [434](#)
- certificate error [234](#), [250](#)
- executing CLI commands [427](#)
- options [434](#)
- refresh interval [434](#)
- vs. XMS [89](#)

WMI management

- IPv6 [90](#)

workflow [71](#)

WPA [4](#), [70](#), [84](#), [167](#), [230](#), [283](#), [526](#), [534](#)

WPA (Wi-Fi Protected Access) and  
WPA2

- encryption method [232](#)

WPA2 [4](#)

WPR

- Cloud [296](#)
- Facebook Wi-Fi [500](#)
- HTTPS pass-through [500](#)

see web page redirect [424](#)  
wpr.pl [424](#), [425](#)

## X

X.509

certificate [234](#), [250](#)

XA4-240 [8](#)

XD4-130 [7](#)

XD4-240 [8](#)

Xirrus

certificate authority [250](#)

Xirrus Management System [4](#), [20](#), [24](#),  
[33](#), [66](#), [534](#)

SNMP required [202](#)

Xirrus Management System (XMS) [1](#)

Xirrus Roaming Protocol [24](#), [111](#), [339](#)

XMS [4](#), [20](#), [24](#)

port requirements [62](#)

setting IP address of [201](#)

SNMP required [202](#)

vs. local management [89](#)

XP PoGE Power Injectors [1](#)

XPS [33](#)

XR Array

management [165](#), [411](#)

XR Arrays [1](#)

overview [4](#)

XR-2000 Series [14](#), [15](#)

XR-2005 Series [14](#), [15](#)

XRP [24](#), [111](#), [339](#)

xs\_current.conf [418](#)