

X10DR Elite Application Notes

Apr 26th 2019



X10DR Elite Handset



X10DR Elite Gateway



base view

Secure Wireless Handset



Gateway Mobile Charger

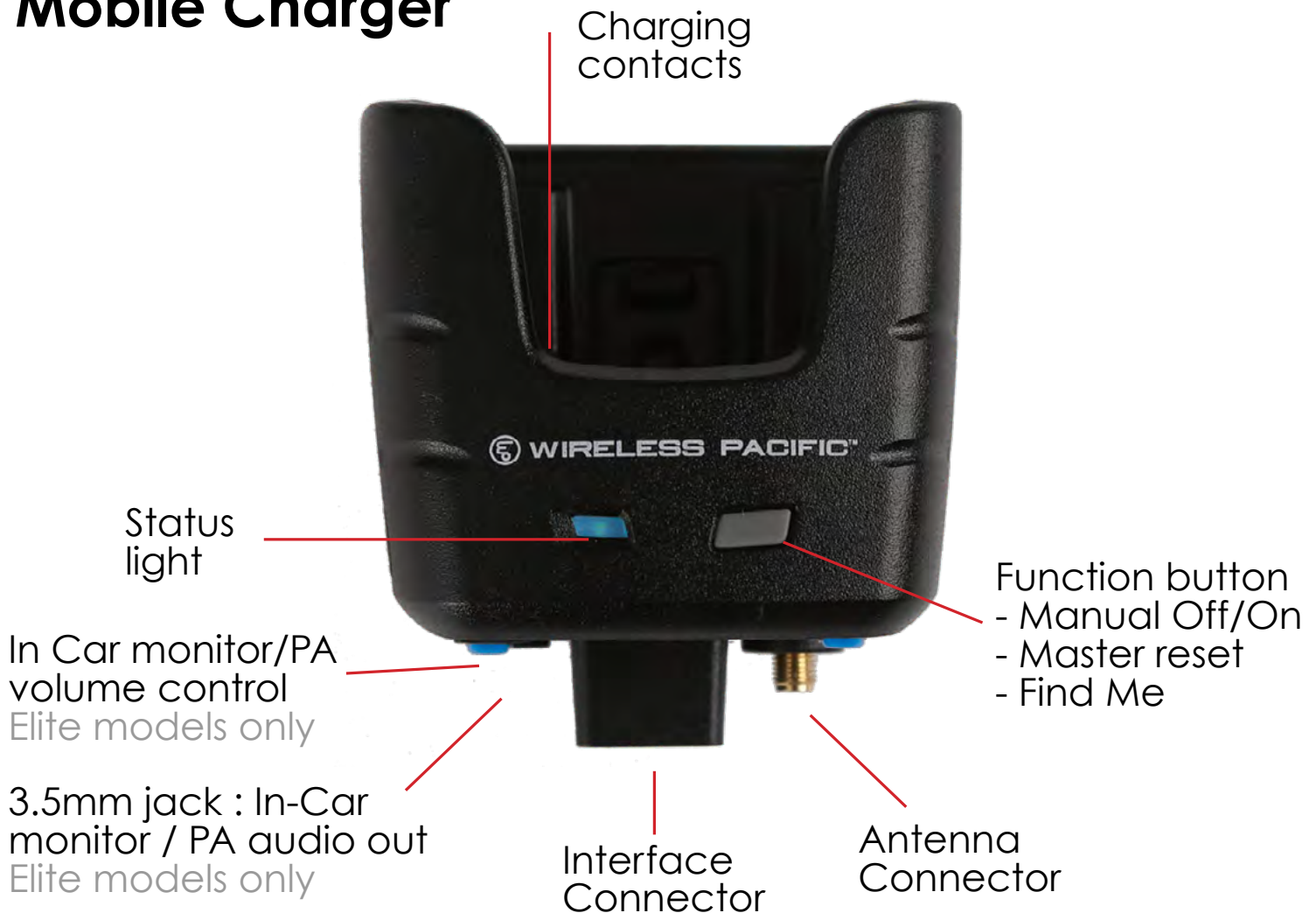

Gateway base view



	Page
Handset Parts	2
Gateway Parts	3
Antennas	5
Interface Cables	6
After Hours charging	7
TDMA DC isolation requirements	8
XSJB & XHJB Overview	9
1 Single Elite Handset/1 Gateway	10
2 Dual Elite Handset/1 Gateway	11
2A Triple Elite Handset/1 Gateway	12
3 Triple Elite Handset/Gateway	13
4 Four Elite Handset/2 Gateway	14
4A Five Elite Handset/2 Gateway	15
5 Single Elite with Public Address	16
5A Single Elite with PA/Footswitch (Bus)	17
6 Single Elite with In Car Monitor	18
7 Single Elite with Dual Mobiles	19
8 Dual Elite HS/1 GW with Dual Mobiles	20
8A Four Elite HS/2 GW with Dual Mobiles	21
9 Single Elite Loneworker with 1/2 Mobiles	22
10 Single Elite Motorcycle	23
11 Four Elite HS/2GW office application	24
12 Triple Elite HS with XRTG in Warehouse	25
12A 4 Elite HS with 2 XRTG in Stadium	26
12B Nine Elite HS AES local Comms System	27
13 Covert applications	28
14 Three Elite HS/1GW- Advanced Emergency	29
15 Handsfree Crane Communications System	30
16 Handsfree Three Elite Handset/ 1Gateway	31
17 Handsfree Six Elite HS/ 2 GW one mobile	32
17A Handsfree Nine Elite HS/ 3 GW one mobile	33
18 Handsfree Six Elite HS/ 2 GW dual mobile	34



XMPA "Sharkfin"

Multipolarity roof/rack mount antenna kit



XMAK

Multipolarity rack mount antenna kit



XMMA

Magnetic mount vehicle antenna kit

Use of an external antenna with careful placement is critical if dependable coverage range is to be achieved around the vehicle. To ensure the user experiences a consistent predictable coverage "bubble", the antenna should be ideally installed on a vehicle so that it has an unobstructed view in all areas where the user may walk.

On some installations however, it may make sense to mount the antenna on a front bull bar if, for example, the user typically would generally try to park the vehicle in the direction of where they intend to mostly communicate. By the same token, if the rear of the vehicle would normally face the users work area, then it may make sense to mount the antenna in a location overseeing the rear of the vehicle. Each vehicle may have its own natural obstacles to deal with, whether they be light bars, ladder racks, storage tubes, etc but as a general rule, the installer should always endeavour to mount the antenna where the user could visually see the XMPA/XMAK/XMMA antenna from the area they would expect to communicate from. If there is any particular directivity anticipated due to the antenna's placement, sharing that anticipated coverage bias with the user will help them establish a clearer understanding of where they should get good reception and where it may be less than perfect when they park their vehicle.

The X10DR is usually supplied with a **multi-polarity antenna** so that the best possible coverage in all overall operating environments can be experienced to each user. Multi-polarity antennas generally provide superior coverage in non 'line of sight' coverage situations, especially when talking into concrete walled buildings or around building corners or other physical obstacles to line of sight communications.

Where X10DR installations require use of multiple antennas, endeavour to keep the antennas ideally at least 1 meter (39") apart for best performance. The installer should also pay careful attention to the mounting locations of all antennas to make sure that each user have as similar coverage experience as is practically possible.



XSMA2 antenna (shorter range - internal use)

In some installations only limited coverage may be required around a vehicle, for example: a pump attendant on fire appliance or when an X10DR is used for mobility for fixed radio console operators in a control room. In those situations it may be more practical to alternatively, simply screw on a XSMA2 antenna directly to the base of the X10DR gateway unit.



XIC/XEC Series Interface Cables

Use with radio specific XCA series adaptors



Type 1



Type 2

XCA Series Adaptors

The X10DR gateway device connects to the mobile radio's rear accessory port by way of a supplied 1.5m (5') XIC interface cable and a separately ordered radio model specific XCA series adaptor.

XCA adaptors are available for most popular mobile radios while adaptors for other models or for unique equipment interfaces can be supplied by custom order.

For remote mounted mobiles, XEC-4.5 extension cables are 4.5 meters (15') in length are available to facilitate mounting the mobile radio in the vehicles trunk. Multiple XEC-4.5 cables can be connected for long installation runs although the number of X10DRs connected to the cable run must be considered with regard to possible DC voltage drops. Additionally, a remote mount 6.2 meter (22') is available when a single cable is preferred.

For those installations requiring custom requested specific length cables, then these are available on special order - MOQ 200 pieces.

XIC-0.5 is a short 50cm interface cable to connect between the following interface boxes and X10DR devices.



XJB Junction Box
Multi interface unit
- Up to 6 X10DRs
- Use with non-TDMA radios



XSJB Smart Junction Box
Multi interface unit
- Up to two X10DRs
- Use for Loneworker
- Use Dual Radio Access



XHJB Handsfree Junction Box
Multi interface unit
- Up to three X10DRs
- Use Single Radio Access
- Use Dual Radio Access



XJB-DCI Junction Box
with DC isolation
Multi interface unit
- Up to 4 X10DRs
- 2 raw DC charger ports
- For any radio (including TDMA)



XDIA Dual Interf. Adaptor
Dual interface unit
- Dual X10DR non TDMA radios
- Simple splitter for:
Dual XJB-DCI
Elite 2nd Mic-Charger
Dual XJB
Dual XSJB etc



XPB-C14 After hours charging for “isolated” vehicle battery installations 10-16 Volt DC input-7.5VDC output

Operational regulations in some agencies require that vehicles have their batteries isolated and disconnected from auxiliary electronic devices at night or whenever the vehicle is being garaged. In such installations, DC power will not be subsequently available for re-charging X10DR Secure Mics that only are returned to the charging cradle at the end of the work day.

For such installation Wireless Pacific created the XPB-C14 Power Bank. The power bank is fitted in line with the standard XIC interface cable that connects the X10DR Gateway Cradle to the host mobile radio. The power bank constantly charges when ever a vehicle’s power is available ensuring it is always fully charged and available, should the vehicles’s battery be isolated from the X10DR device. When a vehicle’s DC power is removed, the XPB Power Bank instantly provides enough reserve to fully re-charge one or two X10DR handsets while the vehicle is garaged. When the vehicle battery is reconnected the XPB automatically re-charge while powering the attached X10DR devices. The XPB-C14 can also also two X10DR’s to be connected to the one mobile radio. Connection to a TDMA radio may also require use of XJB-DCI DC isolation junction box.

Suggested configurations are shown below:

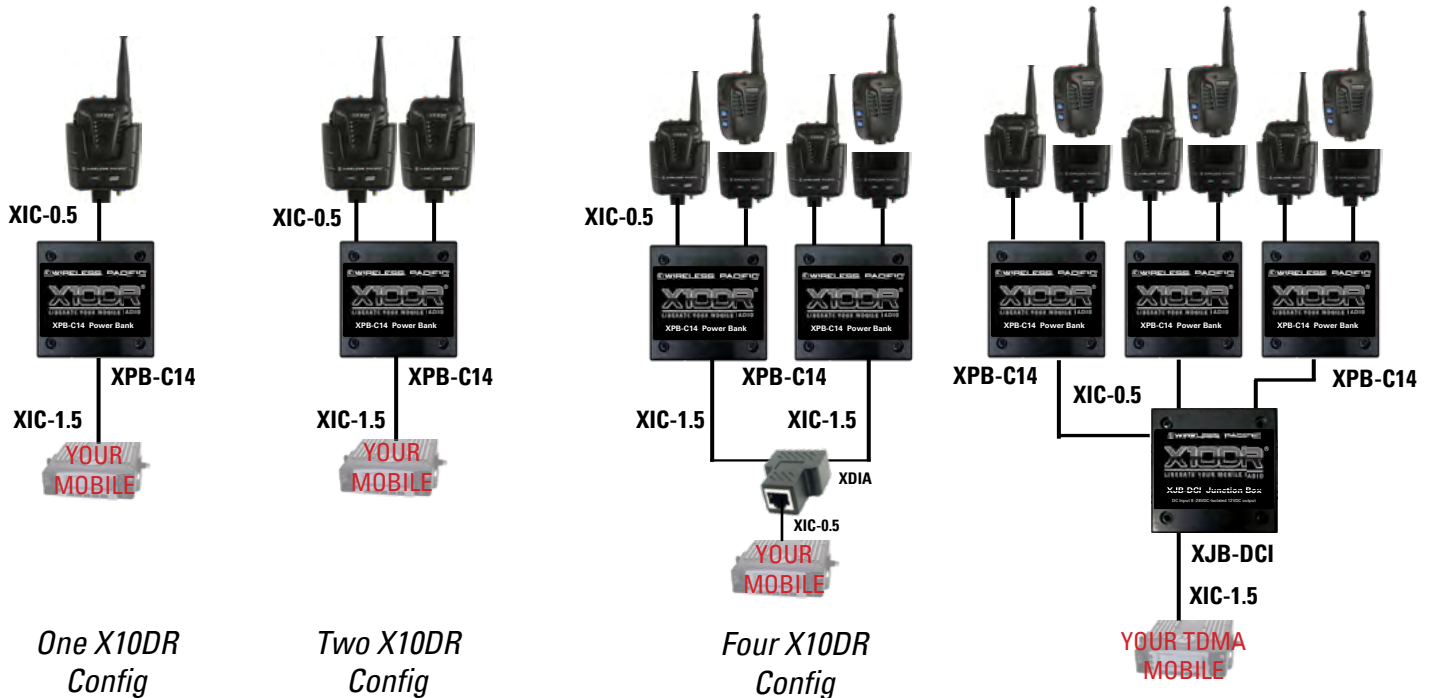

Ordering: 1 x XPB-C14 for every two X10DR connected
1 x XIC-0.5 per XPB-C14 ordered

Three X10DR TDMA Config



XJB-DCI Multi interface unit with DC isolation 9-16 Volt DC input-12VDC output

Connecting modern day digital devices requires careful attention to device **grounding**. Installers should pay special attention to ensuring good grounds are achieved to all antenna mounts and power supplies of all electronic devices. The necessity for good grounding becomes especially important where the quantity of devices sharing a common power supply expands in complexity.

Modern radios incorporating TDMA digital modulation are especially susceptible to creating "ground noise" especially in higher power circuits. Unfortunately, these unwanted ground noises can sometimes be superimposed onto sensitive audio circuits resulting in an annoying buzz being audible in voice transmissions. Experience tells us also the amount of noise heard can be dependent not only on the number of devices connected but by the manufacturer or even by production run of various equipment.

The XJB-DCI has been designed to significantly reduce the levels of these TDMA ground noises and provides four 12V isolated DC outputs to connect to X10DR Gateways and two non-isolated direct Batt+ outputs for powering X10DRMC mobile chargers.

We recommend use of our XJB-DCI Junction box rather than the standard XJB and XDIA interface devices when interfacing multiple X10DRs to ALL TDMA radios. TDMA radios include all TETRA, DMR, MotoTrbo and P25 Phase II radios. The XJB-DCI provides DC isolated 12 volts to operate the X10DR devices.

Suggested configurations are shown below.

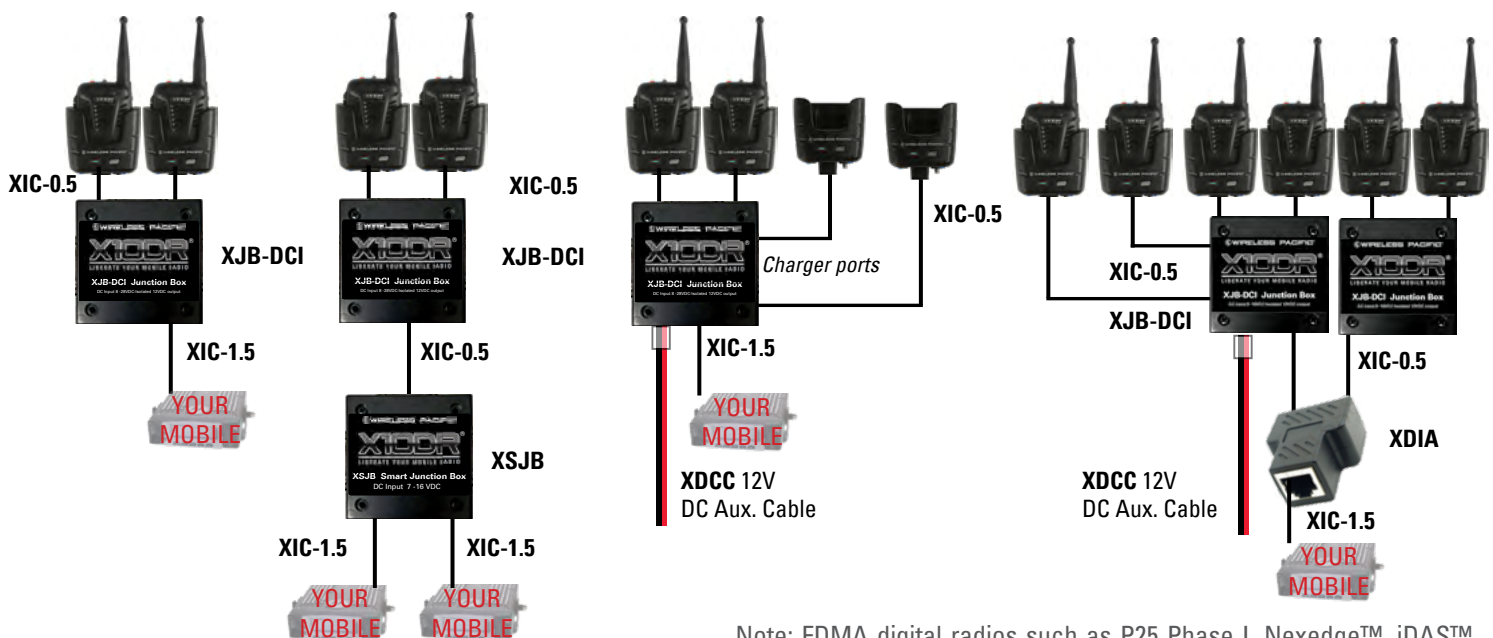

Note: FDMA digital radios such as P25 Phase I, Nexedge™, iDAST™ and dPMR® types allow the use of any combinations of XDIA, XJB, XJB-DCI and XSJB type interface boxes.

XSJB Smart Junction Box

Provides a LoneWorker protocol single port or ports for dual radio control with single or dual gateway connectivity. The Control port provides external access to the LoneWorker pre-alert activity timer settings by way of jumpering specific pins to ground. Refer to XSJB installation instructions for further details.

Dual radio transmit is achieved by pressing normal handset PTT for radio 1 and pressing the top "Control" (normally used for Talkaround) button for radio 2 transmit. All received audios are mixed and sent to handset/s. If desired, radio 2 receptions can have a short audio beep attached to end of each reception so that users can be sure on which radio the reception occurred. The audio level adjustments allow you to set transmit and receive volume levels to each radio as well as the audio level of the radio 2 audio tag. Note: "Off network" talkaround is not available when dual radio control is required. Users however still hear both sides of all conversations.



XHJB Handsfree Junction Box

Provides handsfree specific protocol on three ports for single or dual radio control for one, two or three gateways. Dual radio transmit is achieved by pressing normal handset PTT for radio 1 and pressing the top "Control" (normally used for talkaround) button for radio 2 transmit. All received audios are mixed and sent to handset/s. Radio 2 receptions can include a short audio beep attached to end of each reception so that users can be sure on which radio the reception occurred. The audio level adjustments allow you to set transmit and receive volume levels to each radio as well as the audio level of the radio 2 audio tag. "Off network" talkaround is not available when dual radio control is required. Note: Handsets require "Handsfree Option" to be purchased and programmed, and the Gateway to be programmed for Hardware Option 5 "Handsfree". Users enable handsfree by double press of the top "Control" button.



Single X10DR Elite connected to one mobile radio



The X10DR is connected to the one mobile radio. The user can hear all radio communications as well transmit over the network using the highly textured PTT button. All radio system tones or those emanating from the host mobile will generally be heard by the X10DR user via its duplex audio capability regardless of whether the user is transmitting or not from the X10DR Secure Mic. These tones may include but are not limited to: transmit timer alerts, channel busy tones, talk permit tones, failsoft trunk tones, radio out of range tones, ruthless pre-emption transmissions, etc.

Note: Refer to interface cable, TDMA and antenna application notes before ordering.

Ordering: 1 x X10DR-EX2 Elite X10DR
1 x XCA -** Adaptors ** to suit radio model



Dual X10DR Elite connected to one mobile radio (one gateway)



The Unique design of the Elite X10DR allows two X10DR's to be connected via **one** gateway to the host mobile radio. Both units can hear each others communications as well as all conversations over the radio network.

This unique capability not only significantly reduces the overall cost of a dual vehicle fit up but also allows the use of a single XMPA antenna to provide optimum coverage around the vehicle. Note all communications between the two Secure Mics occurs via the single shared gateway unit. In some situations the maximum range maybe slightly reduced when configured for Dual Mic operation. Should this be of any concern then separate gateways can be considered (See Application Note 3).

To talk locally off net (talkaround), users simply press the talkaround PTT to communicate amongst each other. **All** host mobile radio communication will instantly be heard by both users even if they are transmitting in talkaround mode, so as to ensure no network transmission is ever missed

Normally, a XDIA dual interface adaptor is used to connect to the host radio via the XIC/XCA series interface cable/adaptor. The XDIA then allows both the single X10DRMD gateway and a X10DRMC mobile charger (required for charging 2nd Elite Mic) to be connected by way of short 50cm (20") XIC-0.5 interface cables for simple installation.

The XEX2 2nd Mic Option can be ordered either when purchasing an X10DR-EX2 Elite Secure Microphone or at a later date. To enable the dual mic functionality the Gateway must be first programmed with dual mic using a XFPK field programming kit. Both Elite mics should be then be individually paired as per the standard procedure.

Note: Refer to Interface cable and Antenna Application notes before ordering.

- Ordering:**
- 1 x X10DR-EX2 Elite X10DR
 - 1 X XEX2 Dual Elite Mic option
 - 1 x XCA -** Adaptors ** to suit radio model

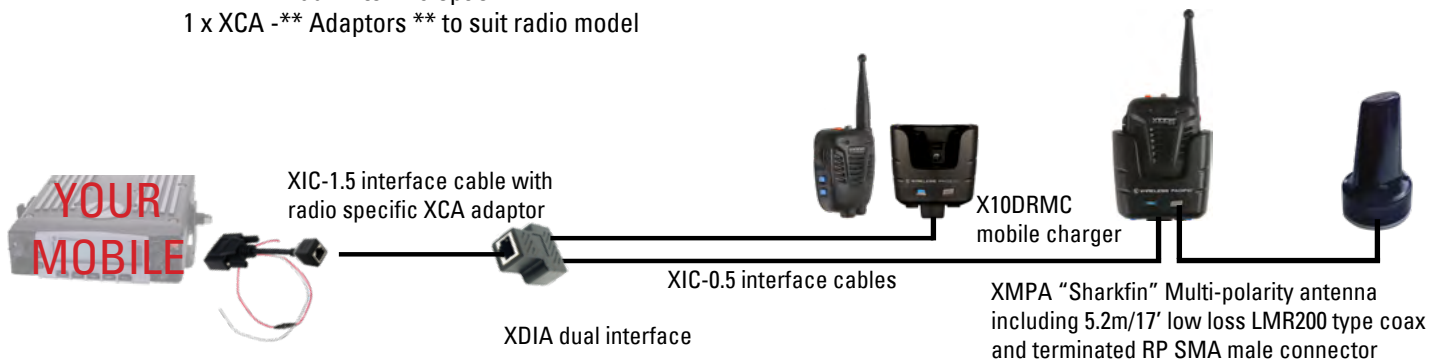

Triple X10DR Elite connected to one mobile radio (one gateway)



The Unique design of the Elite X10DR allows one, two or three X10DR handsets to be connected via **one** gateway to the host mobile radio. All units can hear each others communications as well as all conversations over the radio network. This unique capability not only significantly reduces the overall cost of a triple vehicle fit up but also allows the use of a single XMPA antenna to provide optimum coverage around the vehicle. Note all communications between the two Secure Mics occurs via the single shared gateway unit. In some situations the maximum range maybe slightly reduced when configured for Dual Mic operation. Should this be of any concern then separate gateways can be considered (See Application Note 3).

To talk locally off net (talkaround), users simply press the talkaround PTT to communicate amongst each other. **All** host mobile radio communication will instantly be heard by both users even if they are transmitting in talkaround mode, so as to ensure no network transmission is ever missed

Normally, the supplied XDIA dual interface adaptors are used to connect to the host radio via the XIC/XCA series interface cable/adaptor. The XDIA then allows both the single X10DRMD gateway and the two X10DRMC mobile chargers (required for charging Multi Elite Mics) to be connected by way of short 50cm (20") XIC-0.5 interface cables for simple installation.

The XEX2 2nd Mic Option can be ordered either when purchasing an X10DR-EX2 Elite Secure Microphone or at a later date. To enable the dual mic functionality the Gateway must be first programmed with dual mic using a XFPK field programming kit. Both Elite mics should be then be individually paired as per the standard procedure.

Note: Refer to Interface cable and Antenna Application notes before ordering.

- Ordering:**
- 1 x X10DR-EX2 Elite X10DR
 - 2 x XEX2 Multi Elite Mic option
 - 1 x XCA -** Adaptors ** to suit radio model

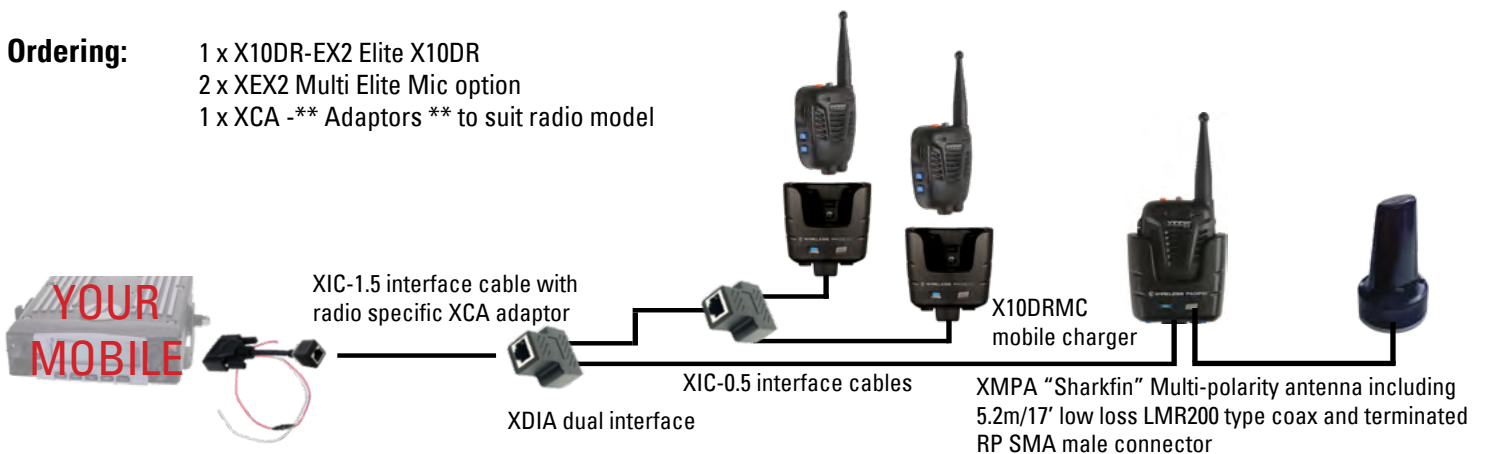

Multiple X10DR Elite connected to one mobile radio (separate gateways)



The smart design of the X10DR allows up to six or more X10DR's to be connected via **one** host mobile radio. All units can hear each others communications as well as all conversations over the radio network. This multiple unit capability provides all users with full access to the radio network as well as local "off net" talkaround capability. Note all communications between the Elite mics occurs via their specific paired gateway unit.

To talk locally off net (talkaround), users simply press the talkaround PTT to communicate amongst each other. **All** host mobile radio communication will instantly be heard by all users even if they are transmitting in talkaround mode, so as to ensure no network transmission is ever missed.

Normally, a XJB junction box is used to connect to the host radio via the XIC/XCA series interface cable/adaptor. The XJB then allows each X10DRMD gateway to be connected by way of short 50cm (20") XIC-0.5 interface cables for simple installation.

Special Note: For installations incorporating the use of TDMA radios such as MotoTrbo, DMR or TETRA radios, we recommend the alternate use of the XJB-DCI isolation box so as to minimize the possibility of TDMA switching noise being transposed by the radio over the X10DR units.

All other functions remain the same.

Note: Refer to interface cable, TDMA and antenna application notes before ordering.

Ordering:

- 3 x X10DR-EX2 Elite X10DR
- 1 x XJB Junction Box (for TDMA Radios use XJB-DCI)
- 3 x XIC-0.5 Interface cable (or 1 if you prefer to use the 2 supplied XIC-1.5 cable)
- 1 x XCA -** Adaptors ** to suit radio model

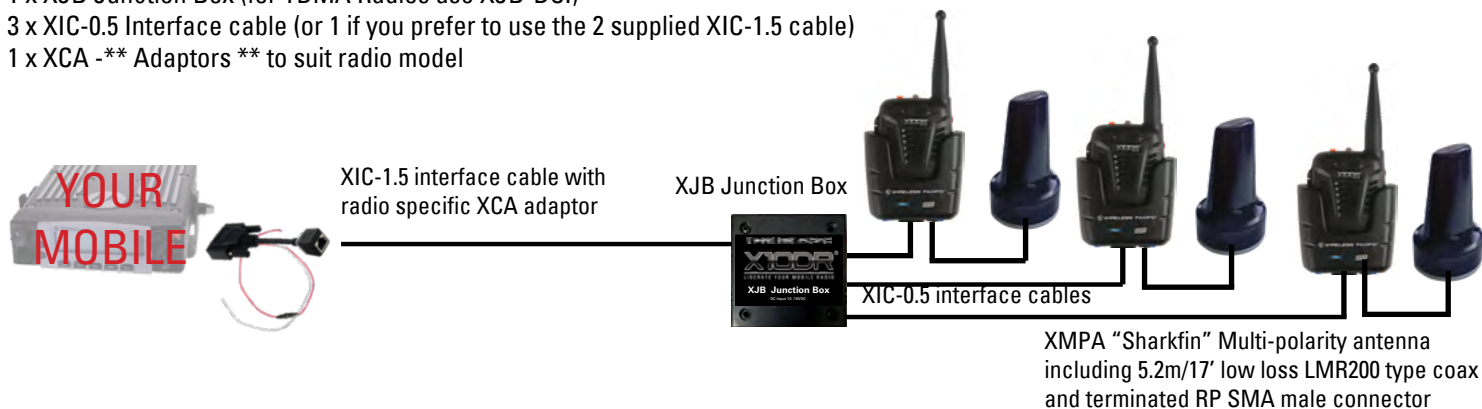

XMPA "Sharkfin" Multi-polarity antenna including 5.2m/17' low loss LMR200 type coax and terminated RP SMA male connector

Multiple Dual X10DR Elite connected to one mobile radio



The X10DR Elite's smart design allows up to six or more X10DR's to be connected via **one** host mobile radio with limited Gateway units by utilizing Elite's Dual Mic capability (Please refer Application Note 2). All units can hear each others communications as well as all conversations over the radio network. This multiple unit capability provides all users with full access to the radio network as well as local "off net" talkaround capability. Note all communications between the Elite mics occurs via their specific paired gateway unit.

To talk locally off net (talkaround), users simply press the talkaround PTT to communicate amongst each other. **All** host mobile radio communication will instantly be heard by all users even if they are transmitting in talkaround mode, so as to ensure no network transmission is ever missed. Normally, a XJB junction box is used to connect to the host radio via the XIC/XCA series interface cable/adaptor. The XJB then allows each X10DRMD gateway and a X10DRMC mobile charger (required for charging 2nd Elite mic) to be connected by way of short 50cm (20") XIC-0.5 interface cables for simple installation.

The XEX2 Multi Mic option can be order either when purchasing an X10DR-EX2 Elite Secure Microphone or at a later date. To enable the dual mic functionality each gateway must be first programmed with Multi mic using a XFPK field programming kit. Each Elite mic should be then be individually paired as per the standard procedure.

All other functions remain the same.

Note: Refer to interface cable, TDMA and antenna application notes before ordering.

- Ordering:**
- 2 x X10DR-EX2 Elite X10DR
 - 2 X XEX2 Extra Elite Handset
 - 1 x XJB Junction Box (For TDMA Radios use XJB-DCI)
 - 1 x XCA -** Adaptors ** to suit radio model

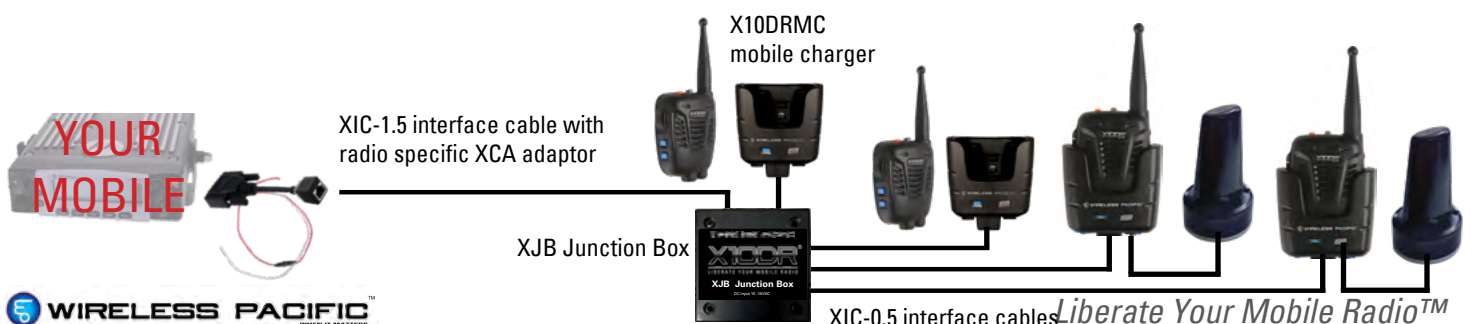

Multiple Dual & Triple X10DR Elite connected to one mobile radio



up to 500 meters

The X10DR Elite's smart design allows up to six or more X10DR's to be connected via **one** host mobile radio with limited Gateway units by utilizing Elite's Dual Mic capability (Please refer Application Note 2). All units can hear each others communications as well as all conversations over the radio network. This multiple unit capability provides all users with full access to the radio network as well as local "off net" talkaround capability. Note all communications between the Elite mics occurs via their specific paired gateway unit.

To talk locally off net (talkaround), users simply press the talkaround PTT to communicate amongst each other. **All** host mobile radio communication will instantly be heard by all users even if they are transmitting in talkaround mode, so as to ensure no network transmission is ever missed. Normally, a XJB junction box is used to connect to the host radio via the XIC/XCA series interface cable/adaptor. The XJB then allows each X10DRMD gateway and a X10DRMC mobile charger (required for charging 2nd Elite mic) to be connected by way of short 50cm (20") XIC-0.5 interface cables for simple installation.

The XEX2 Multi Mic option can be order either when purchasing an X10DR-EX2 Elite Secure Microphone or at a later date. To enable the dual/triple mic functionality each gateway must be first programmed with Multi mic using a XFPK field programming kit. Each Elite mic should be then be individually paired as per the standard procedure.

All other functions remain the same.

Note: Refer to interface cable, TDMA and antenna application notes before ordering.

Ordering:

- 2 x X10DR-EX2 Elite X10DR
- 3 x XEX2 Extra Elite Handset
- 1 x XJB Junction Box (For TDMA Radios use XJB-DCI)
- 1 x XCA -** Adaptors ** to suit radio model
- 1 x X DCC 12V DC Aux Cable

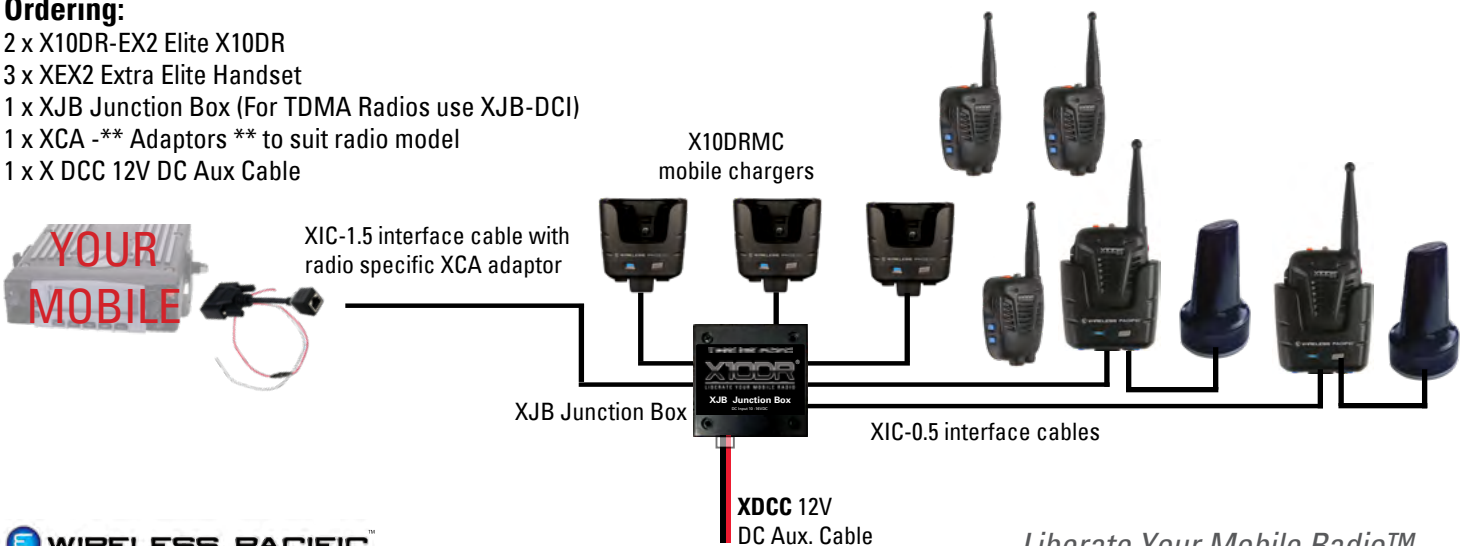

X10DR Elite with Public Address connected to one mobile radio



The X10DR is connected to the one mobile radio. The user can hear all communications as well transmit over the network using the highly textured PTT button. All radio system tones or those emanating from the host mobile will generally be heard by the X10DR user via its duplex audio capability regardless of whether the user is transmitting or not from the X10DR Secure Mic. These tones may include but are not limited to: transmit timer alerts, channel busy tones, talk permit tones, failsoft trunk tones, radio out of range tones, ruthless pre-emption transmissions, etc.

Designed for mission critical users, the Elite X10DR provides an 8 watt RMS audio output as standard. To utilize the facility as a public address system an 8 ohm, suitably rated, horn speaker can be plugged in directly to the 3.5mm audio jack on the base of the gateway unit. The user then utilizes the X10DR Elite mic's Control button as a PA Talk button. The volume is set by up/down press buttons on the base of the gateway. The user should preset the required volume before leaving their vehicle.

All other functions remain the same. If multiple X10DRs have been installed in the vehicle, the other users hear all public address announcements as local talkaround audio. If local talkaround is required between users, the public address system must be turned off (set to minimum volume) to maintain audible privacy.

Note: Public address mode needs to be activated by programming the gateway with the XFPK field programmer.

Note: Refer to interface cable and antenna application notes before ordering.

- Ordering:**
- 1 x X10DR-EX2 Elite X10DR
 - 1 x XCA -** Adaptors ** to suit radio model
 - 1 x Horn Speaker 8 ohm, >10WRMS
 - (Customer supplied)

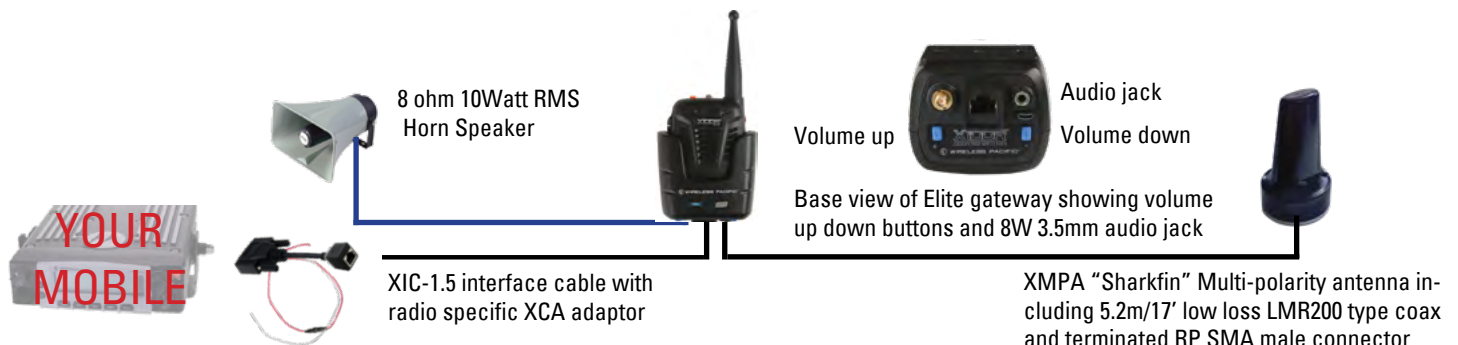

X10DR Elite with *footswitch* PTT and Public Address for Coach/ Bus applications



For Bus and Coach applications, the user typically wears a lightweight single muff headset to maintain communications privacy and to minimize passenger noise when transmitting. The driver is free* to transmit over the radio channel by pressing a floor mounted footswitch whenever seated behind the wheel, or by pressing the highly textured handset's PTT button on all other occasion, either in, or out of the vehicle. Naturally all radio system tones emanating from the host mobile will be heard by the X10DR user via its duplex audio capability regardless of whether the user is transmitting or not.

The Elite X10DR provides a powerful 8 watt RMS audio output as standard making it ideal for more advanced coach and bus applications. To utilize the facility as a public address system either a XMS-8W Elite weatherproof speaker can be mounted internally, or a suitably rated, horn speaker installed externally can be plugged in directly to the 3.5mm audio jack on the base of the gateway unit. The driver then utilizes the X10DR Elite mic's Control button as a PA Talk button. The Public Address volume is set by up/down press buttons on the base of the gateway. The user should preset the required volume before leaving their vehicle.

- Notes:
- i/ Public address mode needs to be activated by programming the gateway with the XFPK field programmer.
 - ii/ In vehicles already equipped with a Public Address system, the PA line input can alternatively be connected to the gateway's 3.5mm audio jack using its up/down press buttons to preset the desired output level.
- * where permitted by local regulatory requirements for use of a radio transmitting device when driving.

- Ordering:**
- 1 x X10DR-EX2 Elite X10DR
 - 1 x WPHFH-X10 Noise cancelling headset
 - 1 x XCA -** Radio specific adaptor
 - 1 x XMS-8W (or Horn Speaker 8 ohm, >10WRMS)
 - 1 x XFS footswitch

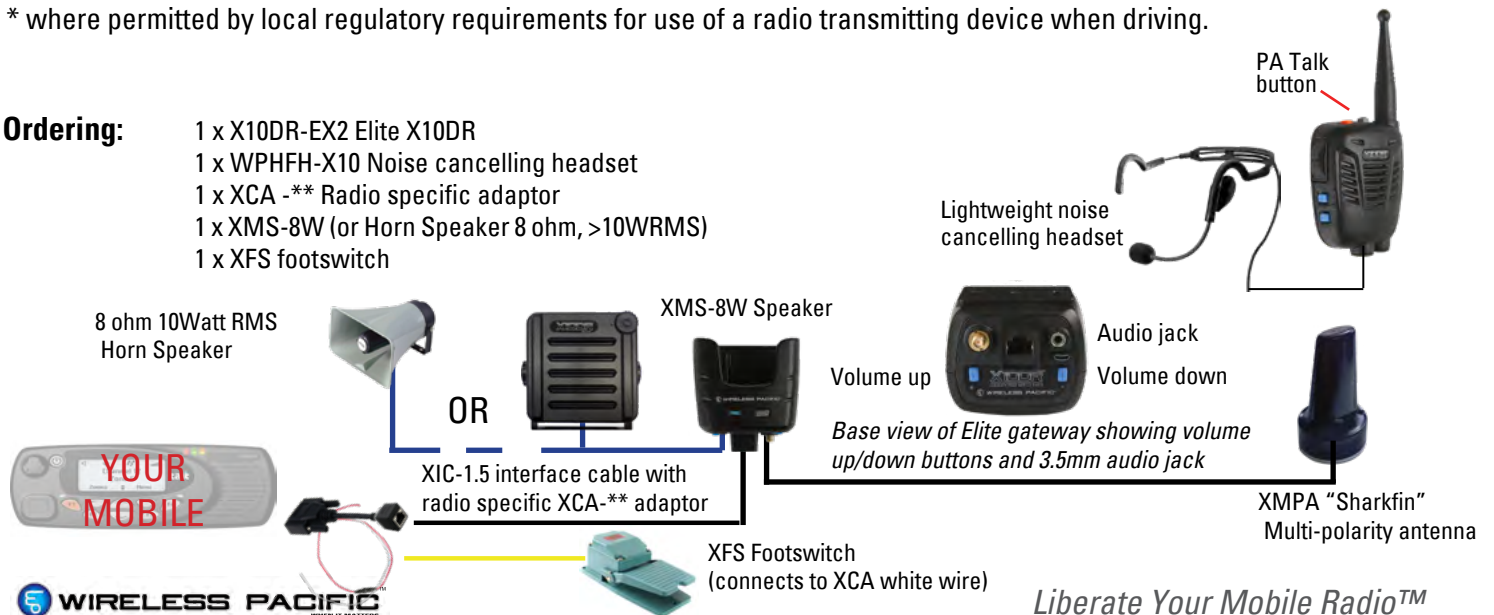

X10DR Elite with in-car monitor connected to one mobile radio



The X10DR is connected to the one mobile radio. The user can hear all communications as well transmit over the network using the highly textured PTT button. All radio system tones or those emanating from the host mobile will generally be heard by the X10DR user via its duplex audio capability regardless of whether the user is transmitting or not from the X10DR Elite mic. These tones may include but are not limited to: Transmit timer alerts, Channel busy tones, Talk permit tones, failsoft trunk tones, radio out of range tones, ruthless pre-emption transmissions, etc.

Designed for mission critical users, the Elite X10DR provides an 8 watt RMS audio output as standard. To utilize the facility for in-car monitor a XMS-8W IP65 rated speaker can be plugged in directly to the 3.5mm audio jack on the base of the gateway unit. All transmissions (both radio and talkaround) from the X10DR Elite mic will then be heard through the speaker. The volume is set by up down press buttons on the base of the gateway. For added convenience the XMS-8W speaker box has a hi/lo volume switch for immediate level setting when the speaker is mounted remotely from the gateway unit.

All other functions remain the same.

Note: Refer to interface cable and antenna application notes before ordering.

Ordering:
 1 x X10DR-EX2 Elite X10DR
 1 x XMC-8W IP65 speaker
 1 x XCA -** adaptors ** to suit radio model

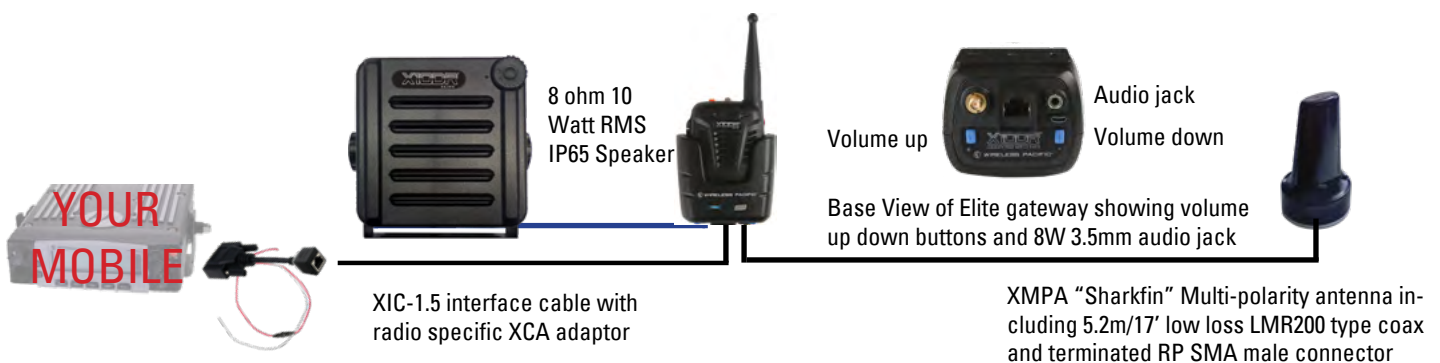

X10DR Elite connected to two mobile radios



The XSJB smart junction box can be used to allow 2 mobile radios to be connected to the one X10DR unit. The user simply presses the PTT button to talk on radio one and uses the Elite mic's Control button as PTT for radio two. A unique marker tone with a pre-adjustable volume level is attached to the tail of each secondary radio reception to inform the user which radio's audio they have just heard. Should either user press their emergency button, both radio's emergency can be triggered.

The XSJB connects to the two host radios via radio model specific XCA series cable adaptors using XIC interface cables. The X10DR connects to the XSJB via a XIC-0.5 interface cable.

All other functions remain the same.

Note: Refer to interface cable and antenna application notes before ordering.

TDMA Radios: Check with Wireless Pacific distributor before ordering. (TDMA = TETRA, DMR & MotoTrbo)

- Ordering:**
- 1 x X10DR-EX2 Elite X10DR
 - 1 x XSJB smart junction box
 - 1 x XIC-1.5 interface cable
 - 1 x XIC-0.5 interface cable
 - 2 x XCA -** adaptors ** to suit radio models

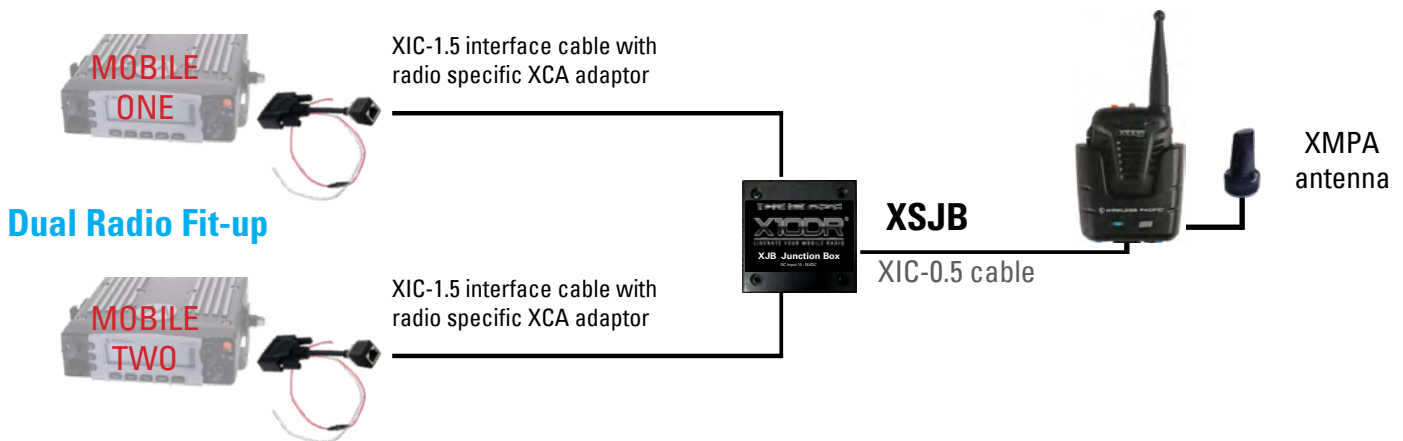

X10DR Elite with Dual Mics connected to two mobile radios



The XSJB smart junction box can be used to allow 2 mobile radios to be connected to two X10DR Elite mics. Each user simply presses the PTT button to talk on radio one and uses the Elite mic's Control button as PTT for radio two. A unique marker tone with a pre-adjustable volume level is attached to the tail of each secondary radio reception to inform the user which radio's audio they have just heard.

Users should use common radio protocol and should not attempt to talk on the second radio when the first user is already talking on radio one. (Doing so would cause both radios to transmit with the audio from both microphones mixed being sent over the air). Should either user press their emergency button, both radio's emergency can be triggered. "Off-net" local talkaround is not available in this configuration but both users hear all communications as usual.

The XSJB connects to the two host radios via radio model specific XCA series cable adaptors using XIC interface cables. The X10DR connects to the XSJB via a XIC-0.5 interface cable.

All other functions remain the same.

Note: Refer to interface cable and antenna application notes before ordering.

TDMA Radios: Check with Wireless Pacific distributor before ordering. (TDMA = TETRA, DMR & MotoTrbo)

- Ordering:**
- 1 x X10DR-EX2 Elite X10DR
 - 1 X XEX2 Extra Elite Handset
 - 1 x XSJB smart junction box
 - 1 x XIC-1.5 interface cable
 - 2 x XCA -** adaptors ** to suit radio models

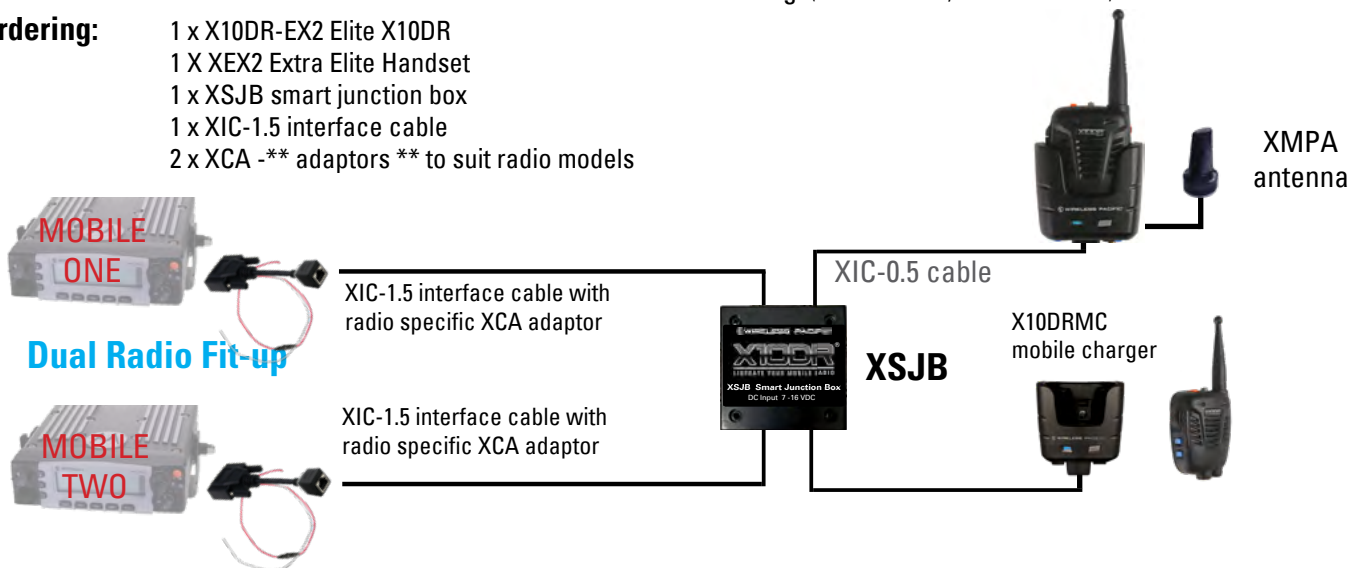

X10DR Elite with Multiple Dual Mics connected to two mobile radios



The XSJB smart junction box can be used to allow 2 mobile radios to be connected to multiple X10DR Elite mics. Each user simply presses the PTT button to talk on radio one and uses the Elite mic's Control button as PTT for radio two. A unique marker tone with a pre-adjustable volume level is attached to the tail of each secondary radio reception to inform the user which radio's audio they have just heard.

Users should use common radio protocol and should not attempt to talk on the second radio when the first user is already talking on radio one. (Doing so would cause both radios to transmit with the audio from both microphones mixed being sent over the air). Should either user press their emergency button, both radio's emergency can be triggered. "Off-net" local talkaround is not available in this configuration but all users hear all communications as usual.

The XSJB connects to the two host radios via radio model specific XCA series cable adaptors using XIC interface cables. The X10DRs connect to the XSJB via XIC-0.5 interface cables via a XJB-DCI junction box.

All other functions remain the same.

Note: Refer to interface cable and antenna application notes before ordering.

TDMA Radios: Check with Wireless Pacific distributor before ordering. (TDMA = TETRA, DMR & MotoTrbo)

- Ordering:**
- 2 x X10DR-EX2 Elite X10DR
 - 2 X XEX2 Extra Elite Handset
 - 1 x XSJB smart junction box
 - 1 x XJB-DCI isolated junction box
 - 1 x XIC-0.5 interface cable
 - 2 x XCA -** adaptors ** to suit radio models

Config for TDMA radios

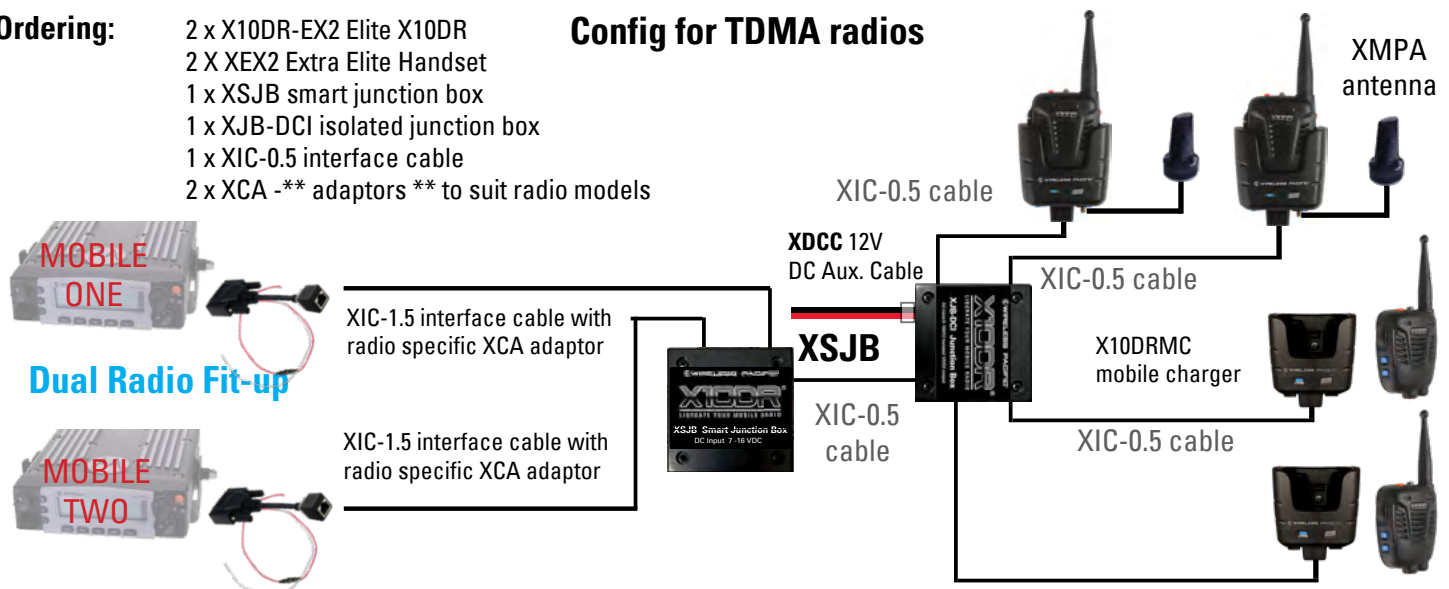

X10DR Elite with Lone Worker connected to one/two mobile radio/s



The XSJB smart junction box can be used to provide Loneworker functionality when connected to one or two mobile radios via the one X10DR unit. Loneworker requires the user to momentarily press the Control button during the default* 15 minute activity timer window. Naturally using the PTT button also resets the activity timer. Should the user fail to press either button during the activity period, a 30 second alert tone will sound in the user’s speaker reminding them to respond. If the user fails to respond, the XSJB will then sound a unique 2 second alarm tone over the radio channel and then trigger the emergency inputs on the attached host mobile radio/s. Loneworker emergency can be reset instantly by pressing either the PTT or Control button, however if the radio’s emergency mode has been triggered that may require resetting of the mobile radio control head or by other means (see your mobile radio user manual)

*The default time of 15 minutes can be changed by configuring the lone worker control port. Alternative timings are 1 and 60 minutes. The Control port also allows Loneworker to be manually enabled or disabled via a customer supplied user switch.

Loneworker uses the Elite gateway default setting “Handset in cradle” to automatically activate when the user removes the Elite mic from the gateway cradle and deactivate when it is returned back for charging. Additionally, should the user move out of range for an extended time, the Elite’s default “handset out of range” output prevents the 30 second user pre-alert tone and subsequent emergency triggering, until such time as the user is back within range of the gateway. Alternative programming of the gateway will cause the XSJB Loneworker application to trigger an emergency regardless of the X10DR Elite mic being out of range or not. Should the user press their emergency button, the emergency alert protocol will start instantly.

The XSJB connects to the host radio/s via radio model specific XCA series cable adaptors using XIC interface cables. The X10DR gateway connects to a **unique** Loneworker port on the XSJB via a XIC-0.5 interface cable. The Loneworker control port is a shielded RJ45 socket. Instructions are included with each device for jumpering or wiring of customer supplied external switches.

All other functions remain the same.

- Ordering:** 1 x X10DR-EX2 Elite X10DR
 (single radio) 1 x XSJB smart junction box
 1 x XIC-0.5 interface cable
 1 x XCA -** adaptors ** to suit radio model

- Ordering:** 1 x X10DR-EX2 Elite X10DR
 (dual radios) 1 x XSJB smart junction box
 1 x XIC-0.5 interface cable
 1 x XIC-1.5 interface cable
 2 x XCA -** adaptors ** to suit radio models

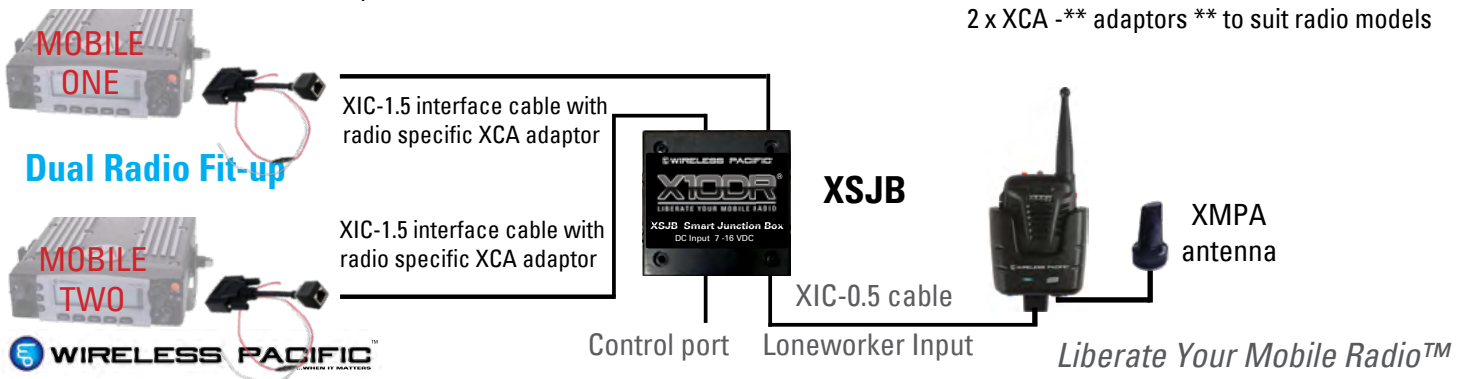

X10DR Elite - Motorcycle connected to one mobile radio



One of X10DR key design criteria was to ensure motorcycle users would be able to enjoy the full benefit of the secure wireless microphone whether on, or off the bike. When on the bike, the officer needs only press the traditional handle bar PTT button to talk thru the helmet's microphone connected to the X10DR Elite mic which then wirelessly connects to the gateway connected to the mobile radio mounted on the bike. When the rider leaves the bike, they can choose to leave their helmet on and press the Elite mic's PTT button to talk. Nothing to un-plug! Alternatively, the officer can unplug their helmet, remove, and use the Elite mic like a traditional remote speaker microphone. No longer will an officer need to return to their bike to do a license check, whilst staying in complete radio contact when at their most vulnerability. Importantly they can stay ready to mount the bike and make pursuit if they need to at any time.

All radio system tones or those emanating from the host mobile will generally be heard by the X10DR user via its duplex audio capability regardless of whether the user is transmitting or not from the X10DR Secure Mic. These tones may include but are not limited to: transmit timer alerts, channel busy tones, talk permit tones, failsoft trunk tones, radio out of range tones, ruthless pre-emption transmissions, etc

Customer supplied handle bar PTT is connected to the white remote PTT wire coming from each XCA adaptor. Two types of Helmet kits are available: XMCH-O for open face helmets and XMCH-C for closed face helmets. Use XFPK field programmer to set optimum mic sensitivity once headset kit is fitted to helmet.

All other functions remain the same.

Ordering:
(Closed face) 1 x X10DR-EX2 Elite X10DR
1 XMCH-C closed helmet headset kit
1 x XCA -** adaptors ** to suit radio model

Ordering:
(Open face) 1 x X10DR-EX2 Elite X10DR
1 XMCH-O open helmet headset kit
1 x XCA -** adaptors ** to suit radio model

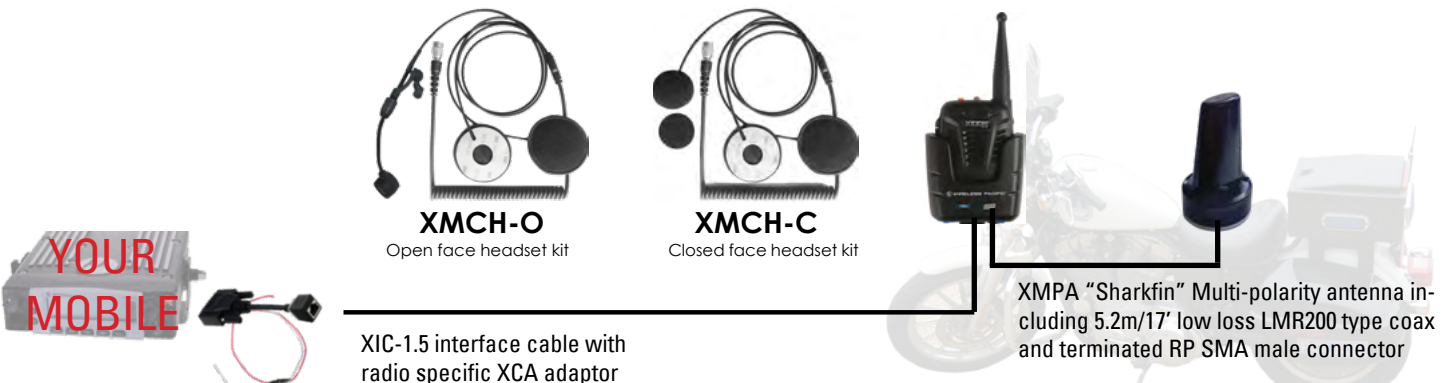

Multiple X10DR Elite in the office connected to one control Station



X10DR is ideal for helping free up desk bound radio operator personnel whose other job responsibilities often cause them to leave the radio control station unattended. A radio dispatcher equipped with an X10DR is now free to move around the office. Additionally, in situations where a number of staff share radio dispatch responsibilities, or where a shift supervisor, or the office in charge may also need to monitor radio traffic, The local off net talkaround facility allow all users to hear each others communications as well as all conversations over the network. Equipping control room staff with X10DR ensures someone will always be available to take an urgent or emergency call even when taking a rest break. For many office situations use of the X SMA2 internal antenna on the gateway units will provide sufficient coverage helping reduce initial installation costs.

To further compliment the office environment, using an X10DR equipped with the Hirose[®] audio port allows use of lightweight noise cancelling headsets to minimize ambient noise in the control room.

Each X10DR Elite gateway connects to the XJB by way of short 50cm (20") XIB-CK connecting cables. Multiple XJB units can be connected where more connectivity is required.

Note: Refer to interface cable, antenna and TDMA application notes before ordering.

Ordering:

- 2 x X10DR-EX2 Elite X10DR
- 2 X XEX2 Extra Elite Handset
- 1 x XJB junction box (For TDMA Radios use XJB-DCI)
- 1 x XCA -** adaptors ** to suit radio model
- 1 x XDCC 12V DC Aux cable

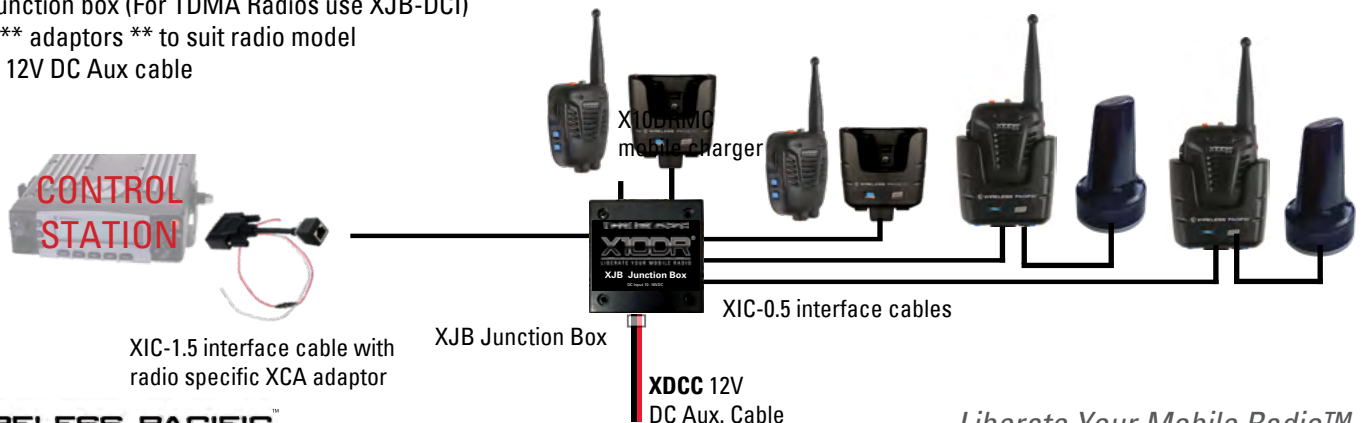

Triple Elite HS with XRTG in Warehouse connected to one Control Station

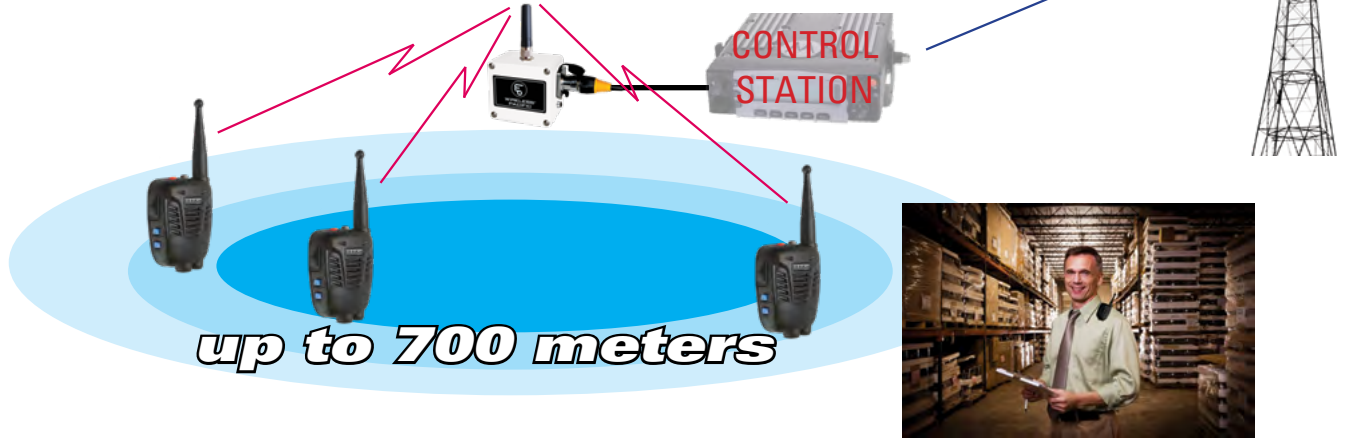

X10DR is ideal for helping stay connected with your remote warehouse personnel. Staff equipped with an X10DR handset are now free to move around the warehouse while communicating amongst themselves using the Talkaround button on the top of the handset, while always monitoring the control station and talking back with the simple press of the PTT .

For many warehouse situations use the 5.2m interface cable will allow the gateway to be mounted high enough to cover the entire warehouse but in those occasions, where due to the warehouse size or obstructions you find coverage is not as desired, the gateway interface cable can be extended up to a hundred meters, allowing its placement to be more central within the building or perhaps on the ceiling etc.

Note: The Elite handsets need to be paired with the XRTG gateway unit BEFORE it is installed. The handset can be recharged in either a single desktop charger or a 6 way desktop charger where that makes more sensible.

To further compliment the office environment, using an X10DR equipped with the Hirose[®] audio port allows use of lightweight noise cancelling headsets to minimize ambient noise in the warehouse area.

The X10DR XRTG connects to the control station by way of the included 5.2 meter (17') XRTC-5.2 Interface cable and a XCA radio specific adaptor.

Note: Refer to interface cable, antenna and TDMA application notes before ordering.

- Ordering:**
- 3 x X10DRSM-EX2 Elite X10DR Handsets
 - 3 x XDTC-US Desk top charger-US AC Plug
 - 1 x XRTG Elite Rooftop Gateway
 - 1 x XCA -** adaptor ** to suit radio model



6 Elite HS with 2 XRTG in Sports stadium connected to one Control Station



X10DR Elite AES 128 secure capability can allow up to six staff to be equipped with an X10DR handset so they can freely move around a sports stadium or warehouse etc while privately communicating instantly amongst themselves for up to 1400 meters using the Control (Talkaround) button on the top of the handset, while always monitoring the control station and talking back with the simple press of the PTT. Alternatively, the main side PTT button can be programmed to be used to talk locally and the top button to talk over the host mobile radio channel. The low cost of these highly secure AES128 Elite handsets makes this a very cost effective way of providing your team with a totally secure local comms system which is license free and exclusive for their use. To further compliment the operational environment, using lightweight noise cancelling headsets to minimize ambient noise in the sports/warehouse area.

The XRTG units connect to a XJB-DCI filtered junction box and via a XIC interface cable to the XCA radio specific adaptor to the host control station. In those situations that the supplied XRTC 5.2m interface cables do not allow the gateways to be mounted high enough to ensure the desired coverage area due to the size or obstructions, the gateway's XIC interface cable can be extended up to a hundred meters, allowing their placement to be more central within the building example: on the ceiling etc. Where multiple XRTG gateways are deployed, we recommend they be mounted at least 3 meters from each other to minimize the opportunity for inter-device interference. The XIC interface cable can be extended with standard XEC-4.5 extensions cables or alternatively, custom length cables are available on application. To maintain local on-site communications in the event of a blackout, a XPB-C14 in linepower bank unit is connected to the XJB-DCI directly to maintain un-powered operation for 8 hours plus.

Notes:

The Elite handsets need to be paired with their assigned XRTG gateway unit BEFORE the XRTG devices are installed. The handset can be recharged in either single desktop chargers or a 6 way desktop charger, as preferred. XRTG units are IP65 weather proof but XJB-DCI units are not and required protection if externally mounted.

Ordering:

6 x	X10DRSM-EX2	Elite X10DR handsets
1 x	X6WC-#	Desktop 6 way charger
2 x	XRTG	Elite rooftop gateway
1 x	XJB-DCI	DC filtered junction box
1 x	XPB-C14	In Line Power Bank power supply
1 x	XCA -**	Cable adaptor ** to suit radio model # Specify AC plug type US/EU/AU/UK

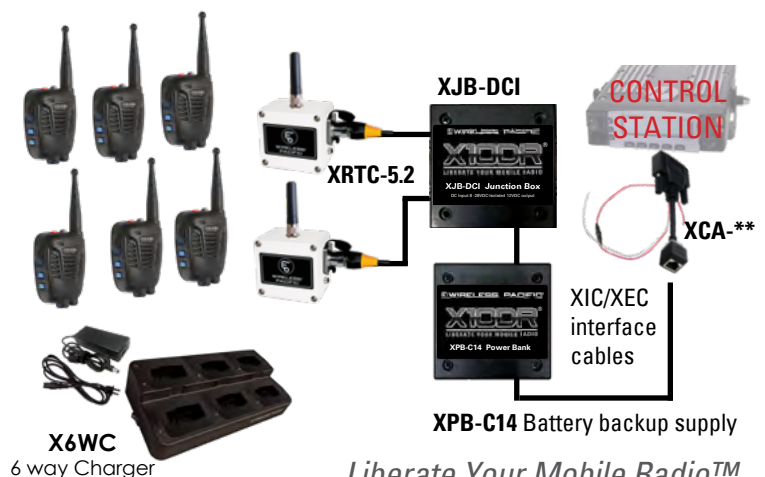

This application can also support 9 handsets by use of a third XRTG gateway- refer application 12b for further details

9 Elite HS with 3 external XRTG gateways

Encrypted local on-site, standalone AES secure comms system



X10DR Elite AES 128 secure capability can allow up to nine users to be equipped with an X10DR handset so they can freely move around a sports stadium, football field, warehouse or other open space location while privately communicating instantly amongst themselves for up to 1400 meters with the simple press of the PTT. The Elite handsets can be optionally be equipped with selectable XHFO Handsfree operation when their tasks demand such. The low cost of these encrypted AES128 Elite handsets makes this a very cost effective way of providing your team with a totally private, highly secure local comms system which is both totally license free and dynamically creates an exclusive private channel for their use anywhere it is deployed. Handsets can be used with a variety of earpieces and noise cancelling headsets to best suit the operational environment.

The IP65 rated weatherproof XRTG gateways should be mounted high enough to cover the desired stadium/warehouse/field area. When multiple gateways are deployed, we suggest the XRTG gateways be mounted at least 2 meters from each other to minimize the opportunity for inter-device interference.

The three X10DR XRTG connect via the included 5.2 meter (17') XRTC-5.2 Interface cables to a XHJB handsfree junction box powered by an external 12VDC power supply. To maintain communications in the event of a blackout, a XRTB-# battery back-up unit can be connected to the XHJB directly to maintain un-powered operation for 8 hours plus.

Notes:

The Elite handsets need to be paired with their assigned XRTG gateway unit BEFORE the XRTG devices are installed. The handsets can be recharged in either a single desktop charger or a 6 way desktop charger, as preferred.

Ordering:

- 9 x X10DRSM-EX2 Elite X10DR handsets
- 9 x XHFO Handsfree option
- 3 x XDTC-# Desktop charger
- 1 x X6WC-# Desktop 6 way charger
- 3 x XRTG Elite rooftop gateway
- 1 x XHFB Handsfree junction box
- 1 x XRTB-# Battery backup with 12v AC/DC power supply
- # Specify AC plug type US/EU/AU/UK

- OPTIONAL**
- XHFH Lightweight handsfree headset
 - WPSHD/SHC-X10 Heavy Duty Headset
 - Other audio accessories as desired

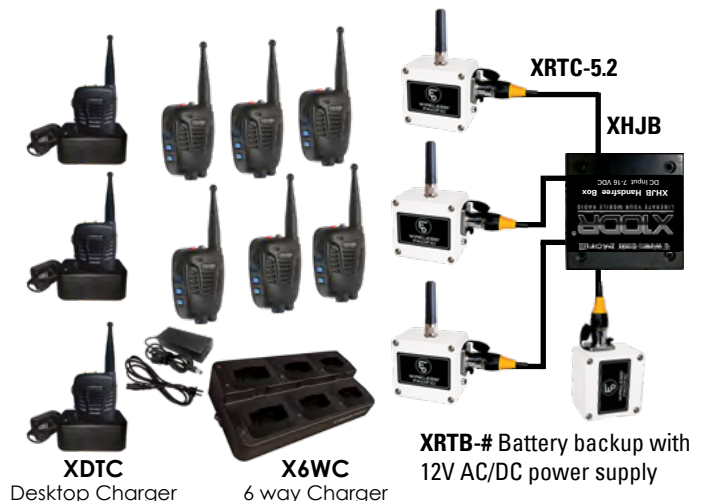

X10DR Elite - Covert Operations



The small size and weight of the X10DR Elite handset allows for its selective use in covert short range applications. Mission Critical focused, Elite model provides AES128 encryption to ensure the highest levels of voice security are maintained. To significantly enhance security even more, X10DR Elite devices continuously automatically reset their encryption key throughout the day, making its operation far more tactically secure than the highest top end AES256 portable radios available in the world today. Depending on the placement of the Gateway terminal device, distances of up to 1400 meters between handsets can be achieved in open environments. All transmissions from handsets are “repeated” via the gateway device with the maximum range between handset and gateway being 700 meters, in optimum conditions.

The remote monitor PTT function means an external operative can enable “remote listening” when the gateway is equipped to a remote monitor capable mobile without the covert operatives having to touch anything. As audio is duplex (bidirectional) the handsets can also be configured so you can also talk to them over the attached host mobile even when an operative is transmitting in **local talkaround mode*** allowing vital messages to be passed on instantly. Handset programming allows handset alert tones and lighting to be disabled either temporarily by the user, or “permanently” until re-programmed.

Integrating one or more X10DR within a tactical mobile suitcase is perfect for low visibility covert surveillance operations. *but NOT when transmitting over the host mobile radio channel.

3 operatives suitcase terminal example

- Ordering:**
- 1 x XRTG Elite X10DR External Gateway
 - 3 x XEX2 Extra Elite Handset
 - 1 x XCA -** adaptor ** to suit radio model



X10DR Elite with Advanced Emergency



Advanced Emergency functionality in the Elite series provide additional alerting capability up and above those available emergency functions provided by the host mobile radio. The Elite microphones can be programmed to generate a short emergency alert tone which is sent over their host mobile's radio channel and to other cross connected X10DR devices. This allows those most able to render quick assistance to respond immediately.

In those situations where it is not desirable to send an emergency alert tone over the radio channel, the Elite gateway's can be programmed alternatively so that emergency alert tones are only sent to their associated paired handsets when ever another cross connected X10DR user presses their emergency button. This advanced emergency feature also provides immediate user feedback that the emergency command has been delivered to their host mobile radio, as the activating unit will also hear the associated emergency alert tones.

Finally, the programmed gateway's emergency i/o pin can be connected a status/message output pin on the host mobile radio so a control room, for example, could send alert tones to the X10DR user to warn of imminent danger. Alternatively, the I/O pin could be connected to the vehicle's burglar alarm system should someone attempt to access the vehicle when the user was remote from the vehicle. When used as an output connect via a XCA-RJ buffer cable to isolate and protect the gateway's emergency pin.

The Advance Emergency capability is available on both on standard Elite configurations as well as multi microphone/single gateway configurations.

Ordering:

- 1 x X10DR-EX2 Elite X10DR
- 2 X XEX2 Extra Elite Handset
- 1 x XCA -** Adaptors ** to suit radio model
- 1 x XJB or XJB-DCI Junction box

XMPA "Sharkfin" Multi-polarity antenna including 5.2m/17' low loss LMR200 type coax and terminated RP SMA male connector

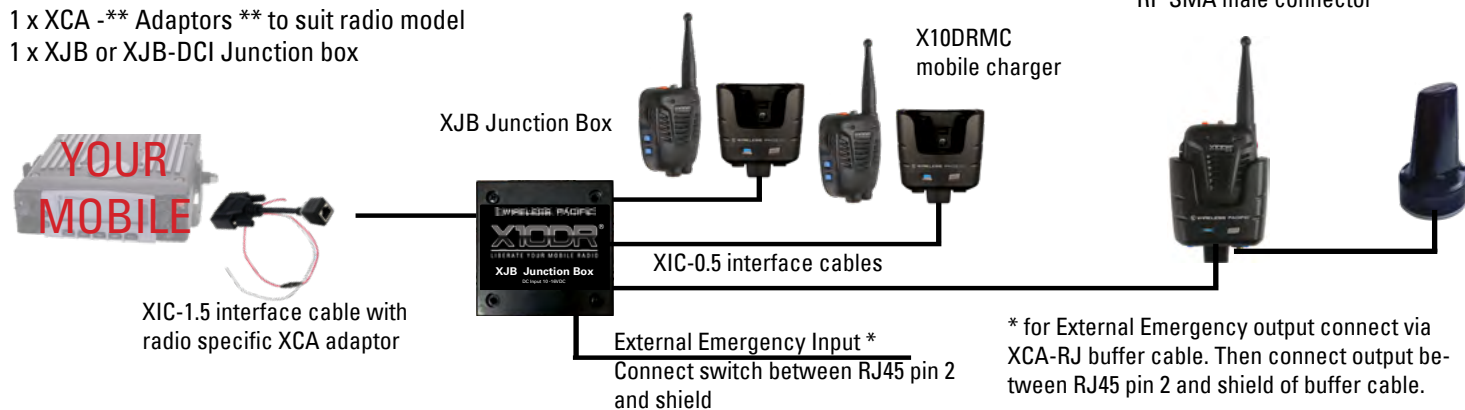

* for External Emergency output connect via XCA-RJ buffer cable. Then connect output between RJ45 pin 2 and shield of buffer cable.

X10DR Elite handsfree Standalone Crane Communication System

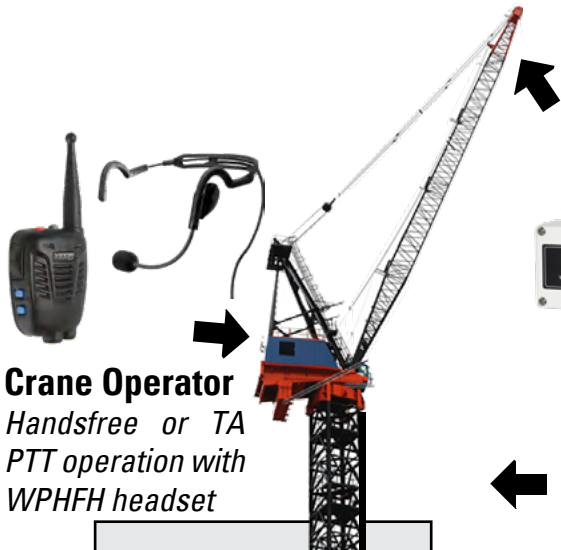

Crane Operator
Handsfree or TA PTT operation with WPHFH headset



XRTG Gateway
Mounted at end of crane boom with XRTB battery back up and AC power input



Dogman 2
Half (TA PTT) or Full (Handsfree) duplex
Simple WPEB earpiece operation (Optional WPHFH headset operation)

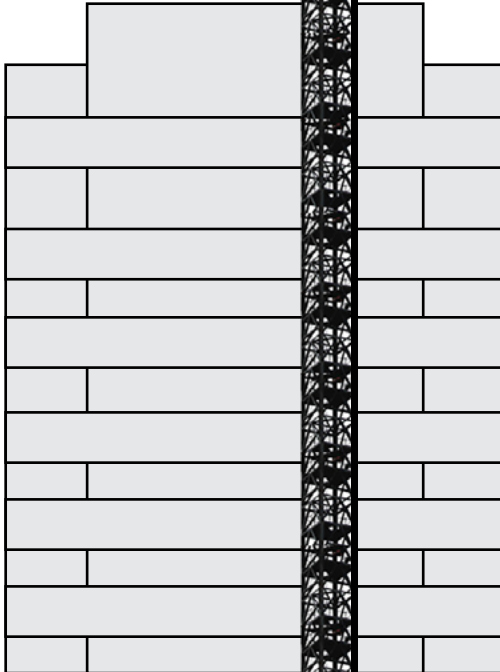

The Unique design of the Elite Handsfree X10DR allows three handsets to be connected via **one** gateway device making it ideal to be used as a standalone Crane Communications system. All handsfree equipped units can hear each others communications, even when they are transmitting, making an Elite handsfree system significantly more suitable for this type of application than traditional two way radios, where the user cannot hear others when they are transmitting. Elite's unique duplex audio capability means all users will always hear every conversation from each of the three team members providing they user has their handset turned on and connected to the crane's dedicated XRTG gateway device.

To ensure the optimum coverage is achieved in the area where communication essential, the XRTG Roof top gateway is mounted at the end of the boom (preferably under sun shading##) so that a direct line of sight is afforded wherever the crane is picking up or dropping its load. The XRTG is powered by AC power via a 4350mA DC battery backup system providing over 48 hours back-up operation from the XRTB-#.

The Elite handsfree system provides a license free, totally exclusive and private voice channel with AES encryption meaning it is impossible for voice breakthrough from any other radio system which might otherwise impact the required absolute safety for crane operation.

Ordering:

- 3 x X10DRSM-EX2 Elite X10DR Handsets
- 3 x XHFO Elite handsfree handset option
- 3 x XDTC-# Desk top charger- specify AC Plug
- 1/2/3 x XHFH-X10 Handsfree headset - as required
- 1 x XRTG Elite Rooftop Gateway
- 1 x XRTB-# XRTG battery back up module w/ AC Plug pack (not weatherproof)
- 1 x XRTC-0.5 XRTG to XRTB interface cable
- 1 x Shade panel## # Specify AC plug type US/EU/AU/UK

In geographic locations where **surface temperatures** may be excessive i.e. > 50°C. Provide by others at time of installation.

XTRG is rated to ~90°C. XRTB is rated to ~55°C. Both are IP65. 12V plug pack is IP44 only - i.e. Cannot be used in wet conditions



Dogman 1
Full (Handsfree) or half (TA PTT) duplex
Simple WPEB earpiece operation (Optional WPHFH headset operation)

Triple Elite Handsfree connected to one mobile radio (one gateway)



Factory fitted Elite X10DR handsets (order option XHF0 for each handset) can be configured so that multiple handsets can communicate locally, "off-net" in Handsfree talkaround. Handsfree mode requires use of an earpiece or a headset for optimum audio performance. To enable Handsfree mode double press* the talkaround button, the handset LED will change to a purple colour and a unique tone will sound and repeat every 30 seconds as a reminder tone. To reset simply press Talkaround button again.

The X10DR has been specifically designed for outside high noise environments and incorporates advanced noise and echo cancelling technology to significantly limit background noise making it suitable for handsfree duplex conversations. Our handsfree mode allows users to communicate securely and privately locally on-site amongst themselves without the need to press to talk. While in many cases not essential, use a plug-in earpiece and locate the X10DR handset device on the user's shoulder, i.e. close to the users mouth for acceptable performance. For best handsfree operation, we would recommend use of noise cancelling headset with a boom microphone which can be located close to the users lips. The X10DR naturally provides programmable external microphone sensitivity so just about any available audio headset device can be supported.

Note: Refer to Interface cable and Antenna Application notes before ordering.

Ordering:
 1 x X10DR-EX2 Elite X10DR
 2 XEX2 Extra Elite Handset
 1 x XCA -** adaptors ** to suit radio model

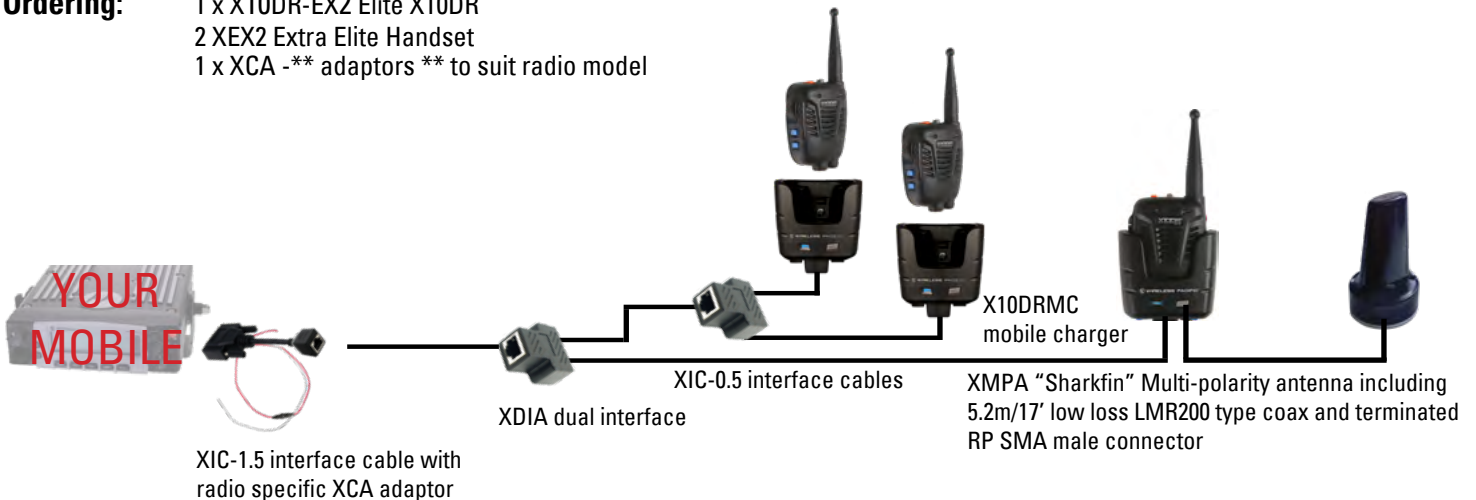

Elite Handsfree with dual Gateways connected to one mobile radio



The XHJB handsfree junction box can be used to connect multiple X10DR Elite mics with XHFO handsfree option to a single mobile radio. For non-handsfree operation, each user simply presses the PTT button to talk on the radio one and uses the Elite mic's Control Talkaround button to talk locally with other team members handsets associated with that vehicle.

Factory fitted Elite X10DR handsets (order option XHFO for each handset) can be configured so that multiple handsets can communicate locally, "off-net" in Handsfree talkaround. Handsfree mode requires use of an earpiece or a headset for optimum audio performance. To enable Handsfree mode double press* the talkaround button, the handset LED will change to a purple colour and a unique tone will sound and repeat every 30 seconds as a reminder tone. To reset simply press Talkaround button again.

When multiple gateways are connected, handsfree by too many simultaneous users may create confusion, in such cases we suggest the default operation be Press To Talk using Talkaround button, with only those users actually requiring hands-free being enabled.

We suggest field trials to find the optimum audio settings and positioning of microphones for both clarity and operational effectiveness for your specific requirements.

The XHFB connects to the host radio via radio model specific XCA series cable adaptor using XIC interface cable. The X10DR gateways connect to the XHJB via XIC-0.5 interface cables. All other functions remain the same as non handsfree models.

- Ordering:**
- 2 x X10DR-EX2 Elite X10DR
 - 2 x XHFO Handsfree option
 - 2 x XEX2 Extra Elite Handset
 - 2 x XHFO Handsfree option
 - 1 x XHJB Handsfree Junction box
 - 1 x XIC-0.5 interface cable
 - 1 x XCA -** adaptor ** to suit radio models
 - 1 x XDCC 12V DC Aux. Cable

Config for Regular - Non TDMA radios

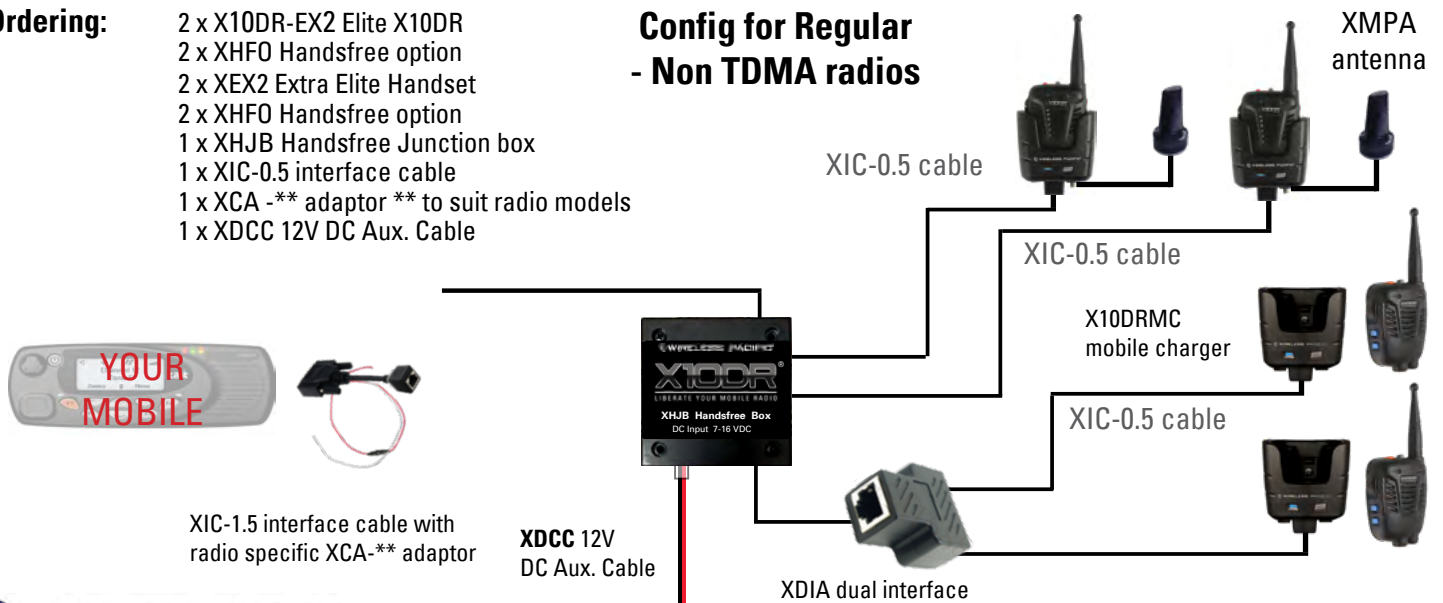

Elite Handsfree with triple Gateways connected to one DMR/TETRA mobile radio



The XHJB handsfree junction box can be used to connect multiple X10DR Elite mics with XHFO handsfree option to a single mobile radio. For non-handsfree operation, each user simply presses the PTT button to talk on the radio one and uses the Elite mic's Control Talkaround button to talk locally with other team members handsets associated with that vehicle.

This application is identical to Elite Application Note 17 but with inclusion of a DC isolation junction box to allow use with any mobile radio including TDMA/DMR/ MotoTrbo™ mobileradios.

Refer Application Note 17 for further information.

Config for DMR/TDMA/FDMA or analog radio

- Ordering:**
- 3 x X10DR-EX2 Elite X10DR
 - 3 x XHFO Handsfree option
 - 6 x XEX2 Extra Elite Handset
 - 6 x XHFO Handsfree option
 - 1 x XHJB Handsfree Junction box
 - 1 x XJB-DCI DC isolation Junction box
 - 1 x XCA -** adaptors ** to suit radio model
 - 1 x XDCC 12V DC Aux. Cable

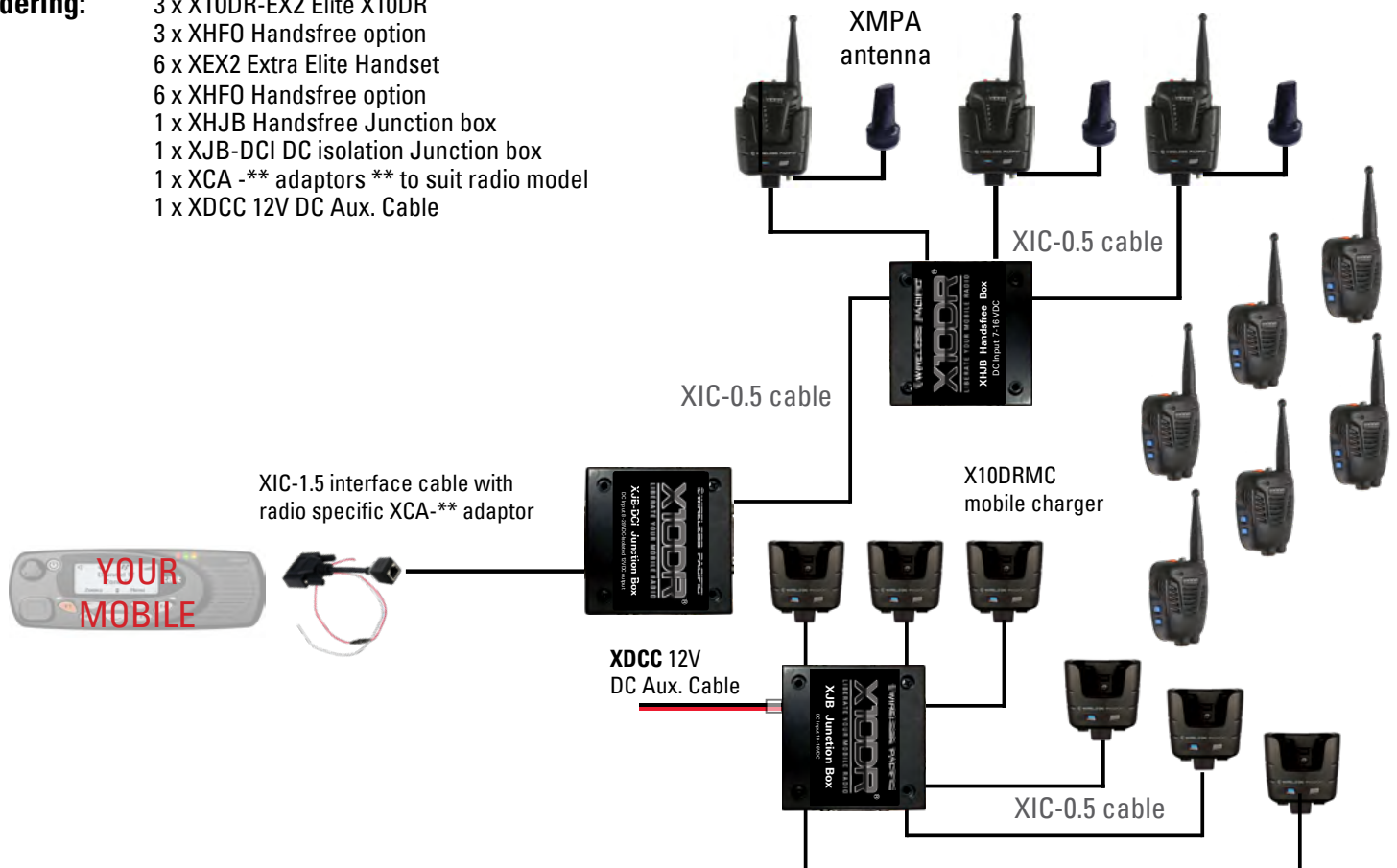

Elite Handsfree with Multiple Gateways connected to two mobile radios



The XHJB handsfree junction box can be used to allow up to 2 mobile radios to be connected to multiple X10DR Elite mics with XHFO handsfree option. For non handsfree operation, each user simply presses the PTT button to talk on radio one and uses the Elite mic's Control button as PTT for radio two. A unique marker tone with a pre-adjustable volume level is attached to the tail of each secondary radio reception to inform the user which radio's audio they have just heard.

Users should use common radio protocol and should not attempt to talk on the second radio when the first user is already talking on radio one. (Doing so would cause both radios to transmit with the audio from both microphones mixed being sent over the air). Should either user press their emergency button, both radio's emergency can be triggered. "Off-net" local talkaround is not available in this dual radio configuration but all users hear all communications as usual as they are sent over the channel.

Handsfree Elite X10DR handsets (order option XHFO for each handset) can be configured so that multiple handsets can also communicate locally, "off-net" in Handsfree talkaround. Handsfree mode requires use of an earpiece or a headset for optimum audio performance. To enable Handsfree mode double press* the talkaround button, the handset LED will change to a purple colour and a unique tone will sound and repeat every 30 seconds as a reminder tone. To reset, simply press the Talkaround button again. Note when handsfree mode is active it is **not possible to transmit** on radio 2 but receive operation remains the same.

We suggest field trials to find the optimum audio settings and positioning of microphones for both clarity and operational effectiveness for your specific requirements.

The XHFB connects to the two host radios via radio model specific XCA series cable adaptors using XIC interface cables. The X10DR gateways connect to the XHJB via XIC-0.5 interface cables via a XJB junction box. All other functions remain the same.

- Ordering:**
- 2 x X10DR-EX2 Elite X10DR
 - 2 x XEX2 Extra Elite Handset
 - 1 x XHJB Handsfree Junction box
 - 1 x XDCC 12V DC Aux. Cable
 - 2 x XCA -** adaptors ** to suit radio models

Config for Regular - Non TDMA radios

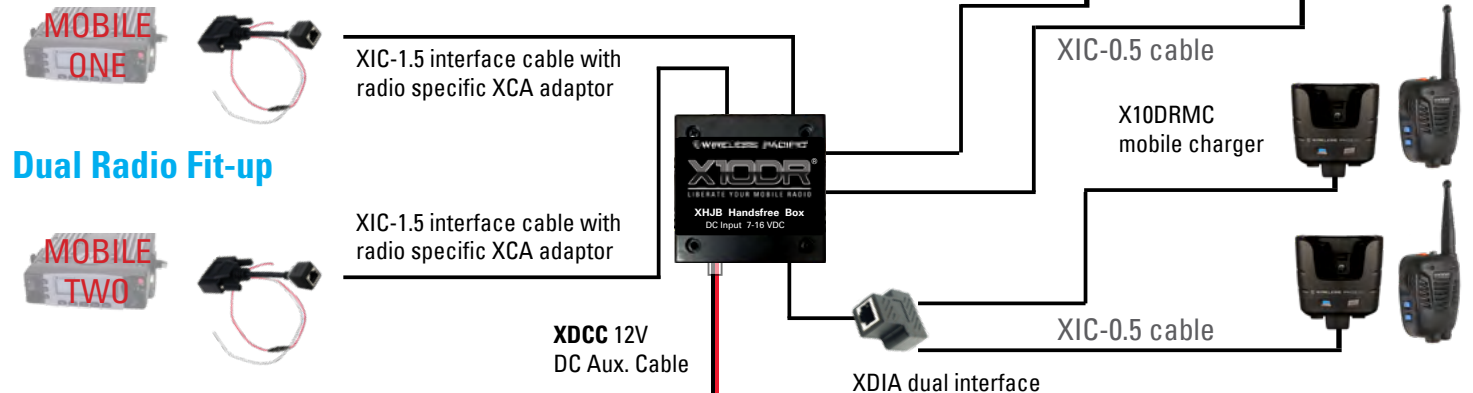

X10DR[®]

X10DR[®]



All rights reserved Wireless Corporation Limited ©2019
Wireless Pacific, X10DR, Liberate your mobile radio and their logos are
trademarks or registered trademarks of Wireless Corporation Limited
Revision 7c