



MXP660

Multi-bearer portable TETRA radio

Frontline safety, today and tomorrow.



MXP660 multi-bearer portable TETRA radio

Frontline safety, today and tomorrow

The MXP660 is a rugged and lightweight, yet fully capable, TETRA portable radio with built-in LTE that's easy to carry and easy to use.

So that vital messages get through, the MXP660 has the option to ramp up to Class 3 TETRA transmission power. If an MXP660 user goes outside of TETRA coverage, the radio can automatically switch to available LTE or Wi-Fi broadband, maintaining DIMETRA™ features and workflows via DIMETRA Connect¹.

Clarity of voice communication is also critical. Noise reduction technology, trained through Artificial Intelligence (AI) machine-learning, is integrated into the MXP660 to suppress loud background noise and improve the clarity of calls – so users can hear and be heard.

The MXP660 also helps reduce your total cost of ownership. Expensive and time-consuming radio management chores are streamlined with LTE and Wi-Fi over-the-air updates. Technologies like Bluetooth® 5.2 and Near-Field Communication (NFC) enable rich and secure collaboration with smartphones, tablets and other Bluetooth devices such as body cameras or audio accessories. The MXP660 protects your existing investment by letting you reuse most of your MXP600 accessories including chargers, batteries and audio accessories².

The MXP660 is ready to respond to sudden changes in the field and future changes in technology. It helps equip your frontline staff to efficiently and effectively get the job done.



¹ For more information about DIMETRA Connect, please visit motorolasolutions.com/dimetraconnect

² Some MXP600 carry accessories are not compatible with the MXP660. For a full list of MXP660 accessories, see TETRA devices accessories catalogue: motorolasolutions.com/mxp660





Mission-critical TETRA portable radio with built-in LTE

Mission-critical TETRA coverage

In some areas, such as rural environments or inside buildings, the range of a portable radio can be limited by its transmission power and its receiver sensitivity.

The MXP660 has the option to ramp up to Class 3 (2.8 W) transmission power. This, coupled with its high receiver sensitivity, helps to keep you connected. This TETRA Class 3 capable radio provides greater range than a Class 4 radio, allowing users to send voice and data messages and make emergency calls even in marginal coverage areas.

The MXP660 can also extend the coverage of other TETRA radios via Direct Mode Operation (DMO) repeater functionality, acting as a bridge between radio users who are out of coverage of each other but within coverage of the MXP660. This can be used to extend DMO range by retransmitting group calls, private calls and data from one TETRA radio to another.

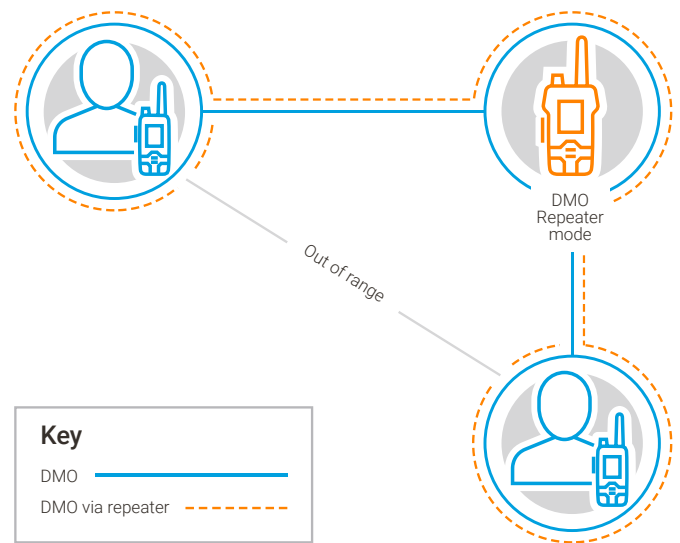

Stay connected via LTE or Wi-Fi broadband

DIMETRA™ Connect enables users to stay connected with their team — even outside of TETRA coverage.

There are times when users may go beyond the range of their TETRA network coverage and need to stay connected. Maybe they are working in heavily built up area, deep inside a building, or even outside their own country or region. In these situations the DIMETRA Connect-enabled MXP660 can use its built-in LTE and Wi-Fi capabilities to stay connected to its TETRA network over broadband.

When there is no TETRA coverage, the MXP660 automatically switches to an available broadband network such as LTE or Wi-Fi. The switchover between TETRA and broadband requires no user intervention. As TETRA packets are routed over broadband, end users maintain their TETRA features and usual workflows. TETRA remains the preferred bearer for all critical communications and the radio will automatically switch back to TETRA when a stable connection is available.

Even outside of TETRA coverage, DIMETRA Connect enables users to stay connected with their team, maintaining their usual workflows.

For more information about DIMETRA Connect visit: motorolasolutions.com/dimetraconnect





Mission-critical audio

The crowd noise during a sports match. The wail of sirens rushing to an incident. How can you be sure your people can communicate when there's so much background noise? And what happens if they can't?

Hearing and being heard clearly are essential on the front line. We built the MXP660 with a powerful 2W loudspeaker that enables your people to hear over crowd noise, machinery and blaring sirens.

Along with the audio volume and quality you'd expect from a Motorola Solutions TETRA portable radio, the MXP660 utilises AI-trained noise suppression, so that your users can communicate with confidence and get vital messages through.

AI-trained noise suppression for clear voice communication

Artificial Intelligence (AI) technology has been used to enhance noise suppression. The microphone audio is processed by the radio, transmitting the user's voice while suppressing other sounds — including extreme noise types such as sirens, crowd noise, wind noise and machinery. The result is significantly improved voice call clarity and intelligibility, even with extreme background noise. The noise suppression of the MXP660 also works with existing MXP600 audio accessories.

You can also select the level of background noise suppression. You may want to eliminate the maximum amount of background noise, or you may want to let some through for the listener to have contextual awareness. The level of noise suppression can be configured by a radio administrator or selected by the end user.

Howling suppression

Frontline personnel often work in teams. Using multiple radios in close proximity to one another can sometimes cause acoustic feedback: howling and distortion, compromising radio communications.

The AI-trained noise suppression also works to suppress acoustic feedback. This enables teams and individuals to focus on the task at hand, rather than being distracted by having to lower audio volume or change acoustic feedback suppression settings manually.

Bluetooth audio

The MXP660 has Bluetooth® 5.2 for audio and data transfer. This makes it easy to connect to Bluetooth accessories, including remote speaker microphones, earpieces and PTT control pods³.

³ For a full list of MXP660 accessories, see TETRA devices accessories catalogue: motorolasolutions.com/mxp660



Location precision for safety and incident management

Being able to pinpoint a frontline worker's location to just a few metres can make all the difference in keeping them safe and effectively managing an incident.

The MXP660 supports four Global Navigation Satellite Systems⁴ (GNSS): Galileo, Beidou, GLONASS and GPS. It also works with regional systems, such as Japan's QZSS. As an example, a combination of GPS plus Galileo provides location accuracy down to 1.2 metres⁵.

Location accuracy makes a big difference: if an emergency button or Fall Alert feature has been activated on the MXP660, it enables dispatchers to pass on more accurate location information to others on the front line, so help can arrive faster.

Built for extreme conditions

Rugged and dependable, the MXP660 is ready for use in extreme conditions.

Tested to military standards⁶, it can withstand drops from 1.2 metres to a hard floor. With IP65, IP66, IP67 and IP68 (2 m, 2 h) ratings, the MXP660 can handle dust, dirt, heavy rain, jets of water and submersion in up to 2 metres of water for 2 hours. Your personnel can work reliably in all kinds of environments and weather, knowing their communications lifeline is intact.

Understanding IP ratings

IP (Ingress Protection) ratings are an international standard used to define the degree of protection provided by mechanical casings and electrical enclosures. The first number defines the degree of protection from solids such as dirt and dust. The second number defines the degree of protection from various liquids and moisture.

Solids

6 Dust-tight with no ingress of dirt for 2 to 8 hours.

Liquids

- 5 Protected against jets of water with limited ingress permitted.
- 6 Protected against water from heavy seas and powerful water jets.
- 7 Can withstand immersion in 15 centimetres to 1 metre of water for 30 minutes.
- 8 Can withstand immersion in water at a depth greater than 1 metre for more than 30 minutes. The MXP660 can withstand immersion at 2 metres for 2 hours.

⁴ Dual GNSS configuration: GPS plus Galileo, GLONASS, or Beidou

⁵ Using industry-standard test protocol

⁶ Refer to the MXP660 specifications sheet for full details motorolasolutions.com/mxp660





Protect your communications with layered security

Threats against public safety communications and critical infrastructure are growing in reach and sophistication. That's why it's important that your communications system uses the most modern security practices and complies with security guidelines. The MXP660 has multiple levels of security to help protect your mission-critical TETRA voice and data communications.

Layered security

MXP660 security features include:

- Air Interface Encryption⁷ (AIE) where voice and data communications are encrypted between devices and base stations.
- Over-The-Air-Rekeying (OTAR)⁸ and Over-The-Air Key Management⁹ (OTAK) that enable radio users to stay out in the field and have their device encryption keys remotely managed.
- End-to-End Encryption (E2EE) closes the gap of unencrypted communications through the TETRA network infrastructure. It is available on the MXP660 via an optional Hardware Security Module (HSM), designed to FIPS 140-2 level 3 hardware specifications. The HSM uses 128-bit AES or 256-bit AES encryption for securing voice, data and location information.

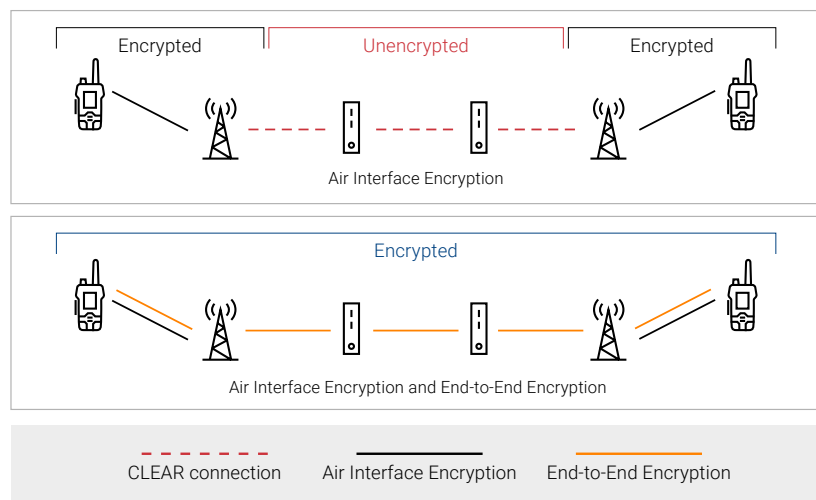

Hardware ready for TEA5, TEA6 and TEA7

The MXP660 is hardware-ready to support dual Air Interface Encryption algorithms¹⁰. It can support the following combination of new algorithms¹⁰, depending on the requirements of the network: TEA 1 and TEA 7; TEA 2 and TEA 5; TEA 3 and TEA 6.

⁷ MXP660 supports TEA1, TEA2, TEA3 and is hardware ready for TEA5, TEA6 and TEA7.

⁸ All OTAR of all ETSI specified AIE Cypher Keys are supported including Group Cypher Key (GCK), Common Cypher Key (CCK) and Static Cypher Key (SCK).

⁹ Supports end-to-end encryption key materials.

¹⁰ Subject to development and regulatory approval.





Secure broadband: Wi-Fi and LTE

To aid secure communications over Wi-Fi the MXP660 supports the WPA2 and WPA3 security standards. WPA3 introduces the Simultaneous Authentication of Equals (SAE) protocol for authentication and also supports forward secrecy where every session is encrypted with a new key.

And for DIMETRA™ Connect security over LTE or Wi-Fi broadband, the MXP660 supports the Secure Real-time Transport Protocol (SRTP) with 256-bit AES encryption for audio calls and Transport Layer Security (TLS) with 256-bit AES encryption for call control and data.

Secure Bluetooth 5.2

The MXP660 uses Bluetooth® 5.2 with Secure Connections (used in security mode 4, level 4 as recommended by NIST¹¹). Secure Connections utilises Bluetooth security practices that include the military-grade AES algorithm, with a 128-bit key length.

Powered for the longest shifts

Frontline staff work long shifts; those shifts can often be extended by unforeseen circumstances. They need a radio that can go the distance.

With a standard 1900 mAh battery and options for extended life batteries up to 3400 mAh, the MXP660 has enough power for even the longest shifts. This ensures workers are never left high and dry in challenging environments, out of contact and without information. But all batteries eventually run out, so we've also made sure it's easy to swap batteries in the field. Nothing should be left to chance on the front line.

¹¹ <https://csrc.nist.gov/publications/detail/sp/800-121/rev-2/final>.

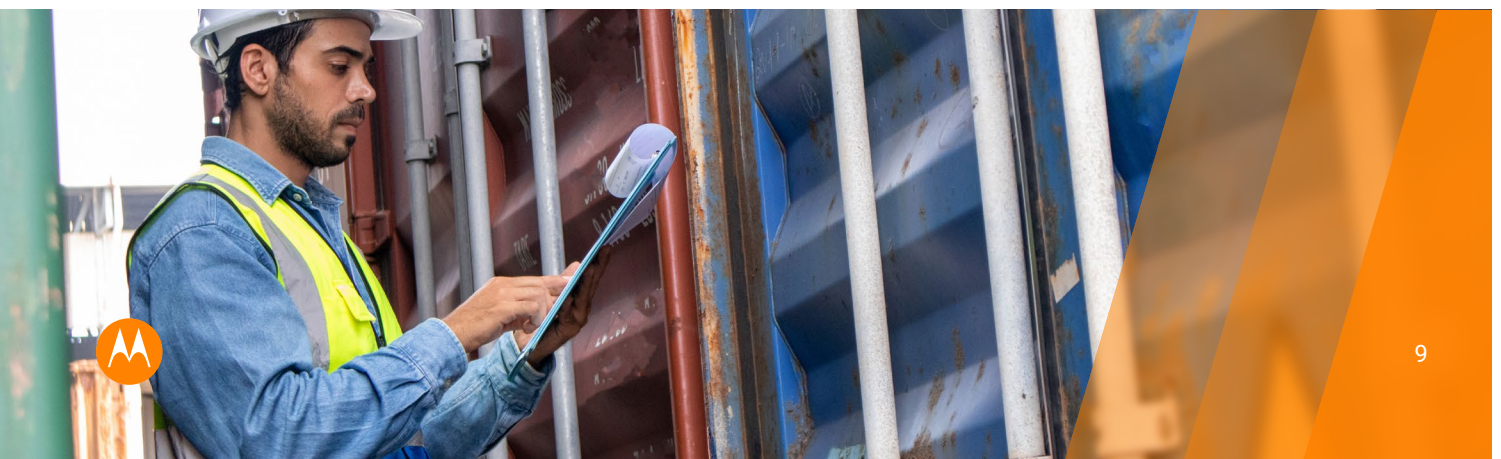



Compact yet easy to use

Small and light — yet fully featured

Your personnel may be on their feet the entire shift, or they may need to enter and exit their vehicle multiple times a day. They may need to work in rough terrain or sprint after a suspect — all the while carrying a lot of equipment.

A small, light radio helps ease that burden — but usability is paramount. The MXP660 is the smallest Class 3 capable TETRA radio with built-in LTE we've ever made, yet it still has a full keypad, large screen, T-bar style grip, and a battery that outlasts a shift.

Easy to carry and easy to wear

As well as being compact and light, it is important that carrying or wearing the MXP660 is as easy as possible, so your users can move around with ease and focus on getting the job done.

We considered how the radio would be carried — on the chest via industry-standard uniform attachments; on a belt clip; in a holster; on a lanyard; on a shoulder harness; or just in the hand, and have a range of carry accessories available to meet different needs.



Easy to use

Frontline staff have no time to fumble with buttons and search for critical information – they need to see and access it instantly.

The MXP660 has a sleek, modern design with a large 2.4 inch screen and a user-friendly, intuitive interface that puts information right at their fingertips. The emergency button is large and easy to operate, yet well protected from accidental activation; there's a tactile glove-friendly push-to-talk (PTT) button that allows easy communication on the job, and there are three programmable side buttons that allow users to activate their most frequently used functions. The T-bar style grip makes the MXP660 easy and comfortable to hold and helps to navigate the programmable side buttons and the PTT button without looking at the device.

With a compact, reliable connector for wired accessories and Bluetooth® 5.2 for wireless connection, it's easy to connect to a range of accessories, including remote speaker microphones and headsets, to tailor performance to individual needs¹².

The MXP660 has a sleek, modern design with a large 2.4 inch screen and a user-friendly, intuitive interface for easy access to critical information.

¹² For a full list of MXP660 accessories, see TETRA devices accessories catalogue: motorolasolutions.com/mxp660





Future-proof features protect your investment

Mission-critical communications today and tomorrow

With a working lifespan of many years, portable TETRA radios are an investment in the future.

The evolution of public safety means that more countries are planning to use mobile broadband alongside their TETRA networks for mission-critical communications. The MXP660, with its built-in LTE capability and support for DIMETRA™ Connect, is well-suited for communication over TETRA and broadband networks, today and in the future.



Tap to connect: fast and easy Bluetooth pairing

The MXP660 comes with integrated Near Field Communication (NFC).

NFC lets smartphones and tablets initiate pairing easily using Bluetooth®, just by tapping the smartphone or tablet and the radio together¹³. This feature is especially convenient at the start of a shift when many people may be pairing or searching for Bluetooth devices.

Because security is so important, we follow the NIST recommendations supporting out-of-band (OOB) pairing verification during the Bluetooth pairing process, to mitigate man-in-the-middle attacks.

Bluetooth also enables pairing with your body camera, enabling one button to do the job of two, saving valuable seconds in an emergency. Capture evidence and call for backup simultaneously by activating your Motorola Solutions body camera when your MXP660 radio enters an emergency state.

Radio control from a smartphone or tablet

We've designed the MXP660 to be easy to use, with a large screen and intuitive hardware controls. Frontline personnel often work in conditions where it's not convenient to detach and operate a radio, or covert scenarios where having a radio on display might not be desirable. For these situations, we've made it quick and easy to securely pair an Android™ smartphone or tablet with the MXP660 over Bluetooth 5.2, then use the collaborative M-Radio Control app to control the radio.

The M-Radio Control app is particularly useful for deeper interaction with the radio, such as searching for talkgroups, sending status updates, and sending SDS messages; while keeping the radio attached to the body — or discreetly out of sight — for instant, easy communication.

¹³ Requires smartphone NFC support





Designed for low total cost of ownership

Backward-compatible, forward-thinking

The MXP660 is compatible with your existing MXP600 chargers, audio accessories and programming software.

With an intuitive and familiar look and feel, it also requires minimal training so your users can get up and running quickly and easily.

These features make the MXP660 a sound financial choice with a low cost of ownership and easier migration, saving money upfront and over the course of many years.

Fast and efficient radio updates over the air

Keeping your radio fleet up to date with the latest codeplugs and firmware is vital. Failure to do this could mean that some features no longer work properly in the field, a cybersecurity vulnerability isn't patched, or users may not have access to the talkgroups they need. This could leave users vulnerable to eavesdropping or communication interruptions.

Traditionally, upgrades required radios to be taken to a radio maintenance base where they would be docked and updated. With a large fleet of radios, this could be costly and time-consuming. To make maintaining and managing fleets of radios easier and faster, the MXP660 supports secure over-the-air updates for firmware and over-the-air programming for codeplugs. Connections between the radio and the Integrated Terminal Management (ITM) server are secured via the Transport Layer Security protocol.

Firmware and codeplug updates can be handled remotely in the field, in the background, while the radio is still in use. Radio administrators can wirelessly program many MXP660 radios at once. Planned upgrades that would have taken weeks can now be done in a few hours of days.



Over-the-air programming for codeplug updates over TETRA, LTE and Wi-Fi

Over-the-air programming (OTAP) is useful for urgent codeplug changes such as changes to radio settings, talkgroups, status messages and contact lists. Codeplugs on the MXP660 can be reconfigured or upgraded via TETRA, LTE or Wi-Fi, while the radio is in use in the field.

Over-the-air updates for firmware over LTE and Wi-Fi

Taking advantage of the broad data pipe of LTE and Wi-Fi, over-the-air updates (OTA Updates) are suited to updating firmware. As the MXP660 supports LTE and both 2.4GHz and 5GHz bands of Wi-Fi, new radio firmware updates quickly download to the radio while it's in operation, eliminating downtime.



With OTAP and OTA Updates planned upgrades that would have taken weeks can now be done in a few hours or days.





Built for the front line



Large dedicated emergency button

Coverage Indicator

Volume and talkgroup control knob

Top front microphone

DIMETRA™ Connect-enabled

Bluetooth® 5.2

Built-in LTE

TETRA antenna with different length options

T-bar style grip

Lanyard / hand strap attachment

Large 2.4" colour display

Dust cover



Carry attachment point

Prominent PTT button

Three programmable buttons

Battery latch

NFC tag



Compact wired accessory connector

Labelling area

Integrated loudspeaker

Bottom microphone

Compatible with existing MXP600 chargers



Accessories to meet your needs

Provide a radio experience tailored to your team and their unique needs with a wide range of access accessories available for the MXP660.



Audio

Loud and clear, designed for comfort and wearability

A range of wired and wireless audio accessories enable a tailored experience. Bluetooth® 5.2 provides fast and secure wireless connectivity, while the sleek and compact GCAI-mini wired accessory port is designed for improved wearability.

Energy

Power for long shifts

If the battery dies, it jeopardises the mission. We offer a range of batteries from the lightweight and slim 1900 mAh battery to the 3400 mAh high-capacity battery – so the MXP660 works when you need it.

For working in cold environments, the 2900 mAh battery works down to -30°C ¹⁴. A variety of flexible charging solutions enable charging of one or up to twenty-four batteries simultaneously – so your radios are ready for the next shift.

Carry

Secure, easy access

Whether the members of your team want to wear the radio on the shoulder, chest or hip – there's a carry accessory to meet their needs. Choose from a range of carry cases, straps, shoulder-wearing accessories and belt clips, all designed for easy, yet secure access to the MXP660 radio – so your team can stay hands free and focused on the task ahead.

For a complete list of MXP660 accessories, please visit www.motorolasolutions.com/MXP660

¹⁴ Performance may be limited when operating at extreme temperatures





Device services

Achieve mission critical performance

Radio performance is critical for effective operations. Your users rely on their radios to be available and connected.

To help support the performance of your MXP660 radio fleet and maximise the value of your investment, we offer a variety of service packages¹⁵ that include the following capabilities:

Hardware repair

Troubleshooting, testing and repair of your equipment at a centralised facility.

You can rely on us to help you achieve your device performance targets and maximise the value of your radio investments with the right level of services for your needs.

Accidental damage cover

When the unexpected happens, we have you covered with a quick repair turnaround.

Technical support and service desk

Remote technical support services to ensure that your radios are rapidly restored and functional.

Software maintenance

Access to the latest certified software releases for reliable and secure device operations.

¹⁵ For more information about the service packages, please contact your Motorola Solutions representative.











MOTOROLA



Main Menu

-  Messages
-  Contacts
-  Bluetooth
-  Security
-  Setup
-  Recent Calls
-  Shortcuts

Select

Back





To learn more, visit:

www.motorolasolutions.com/mxp660



Motorola Solutions Ltd., Nova South, 160 Victoria Street, London, SW1E 5LB, United Kingdom

MOTOROLA, MOTO, MOTOROLA SOLUTIONS and the Stylized M Logo are trademarks or registered trademarks of Motorola Trademark Holdings, LLC and are used under license. All other trademarks are the property of their respective owners. ©2024 Motorola Solutions, Inc. All rights reserved. 04-2024 [CY01]