

ASTRO APX MOBILE

DUAL-RADIO O7 CONTROL HEAD SYSTEM INSTRUCTION MANUAL



Foreword

The information contained in this manual relates to the ASTRO® APX Mobile Dual-Radio with O7 Control Head System. It will be referred to as Dual-Radio throughout this manual, unless otherwise specified. This manual provides sufficient information to enable an individual to install, configure, operate, and troubleshoot an ASTRO® APX Mobile Dual-Radio O7 Control Head System. Refer to “[Related Publications](#)”, which details other related manual references.

Product Safety and RF Exposure Compliance

ATTENTION! Before using this radio, read the guide enclosed with your radio, which contains important operating instructions for safe usage and RF energy awareness and control for compliance with applicable standards and regulations.
--

For a list of Motorola-approved antennas, batteries, and other accessories, visit the following web site which lists approved accessories: <http://www.motorolasolutions.com>.

Manual Revisions

Changes which occur after this manual is printed are described in PMRs (Publication Manual Revisions). These PMRs provide complete replacement pages for all added, changed, and deleted items. To obtain PMRs, go to <https://businessonline.motorolasolutions.com>.

Computer Software Copyrights

The Motorola products described in this manual may include copyrighted Motorola computer programs stored in semiconductor memories or other media. Laws in the United States and other countries preserve for Motorola certain exclusive rights for copyrighted computer programs, including, but not limited to, the exclusive right to copy or reproduce in any form the copyrighted computer program. Accordingly, any copyrighted Motorola computer programs contained in the Motorola products described in this manual may not be copied, reproduced, modified, reverse-engineered, or distributed in any manner without the express written permission of Motorola. Furthermore, the purchase of Motorola products shall not be deemed to grant either directly or by implication, estoppel, or otherwise, any license under the copyrights, patents or patent applications of Motorola, except for the normal non-exclusive license to use that arises by operation of law in the sale of a product.

Document Copyrights

No duplication or distribution of this document or any portion thereof shall take place without the express written permission of Motorola. No part of this manual may be reproduced, distributed, or transmitted in any form or by any means, electronic or mechanical, for any purpose without the express written permission of Motorola.

Disclaimer

The information in this document is carefully examined, and is believed to be entirely reliable. However, no responsibility is assumed for inaccuracies. Furthermore, Motorola reserves the right to make changes to any products herein to improve readability, function, or design. Motorola does not assume any liability arising out of the applications or use of any product or circuit described herein; nor does it cover any license under its patent rights nor the rights of others.

Trademarks

MOTOROLA, MOTO, MOTOROLA SOLUTIONS and the Stylized M logo are trademarks or registered trademarks of Motorola Trademark Holdings, LLC and are used under license. All other trademarks are the property of their respective owners.

© 2014 Motorola Solutions, Inc. All rights reserved.

Notes

Table of Contents

Foreword..... i

Product Safety and RF Exposure Compliance..... i

Manual Revisions..... i

Computer Software Copyrights..... i

Document Copyrights..... i

Disclaimer..... i

Trademarks..... i

List of Figures vii

List of Tables..... ix

Chapter 1 Introduction..... 1-1

1.1 General..... 1-1

1.1.1 APX Dual-Radio Software 1-2

1.2 Ordering Information 1-2

1.3 Notations Used in This Manual 1-3

Chapter 2 APX Mobile Dual-Radio Operation 2-1

2.1 Overview 2-1

2.2 Initial Radio Setup 2-1

2.3 O7 Control-Head Operation 2-2

2.3.1 Display..... 2-2

2.3.2 Basic Radio and Control Head Control 2-2

2.3.3 Backlight..... 2-3

2.3.3.1 Intelligent Lighting 2-3

2.3.4 Volume Operation 2-3

2.4 Feature Operation 2-3

2.4.1 APX Dual-Radio Indication 2-3

2.4.2 Radio Swap 2-3

2.4.3 PTT Operation..... 2-4

2.4.4 Emergency Operation 2-4

2.4.5 Radio Wide Features..... 2-4

2.4.5.1 Siren..... 2-4

2.4.5.2 Light Bar..... 2-4

2.4.5.3 Gun Lock..... 2-5

2.4.5.4 Aux Control..... 2-5

2.4.6 Advanced Unmute Rule 2-5

2.4.7 Radio Inhibit 2-5

2.4.8 Over-The-Air Rekeying (OTAR) 2-5

2.4.9 Audio 2-5

2.4.10 Radio Profile..... 2-6

2.4.11 Model Display..... 2-6

2.4.12 Data Terminal..... 2-6

2.5	Hot Red Receiver (HRR) Solution.....	2-6
2.6	Button Configuration.....	2-7
2.7	Programming.....	2-7
2.7.1	FLASHport® Upgrade	2-7
2.8	APX Dual-Radio User Interface.....	2-8
Chapter 3	Codeplug Configuration.....	3-1
3.1	Overview	3-1
3.1.1	Enabling APX Dual-Radio as Primary or Secondary Radio	3-1
3.1.2	Configuring APX Dual-Radio Emergency Operation	3-2
3.1.3	Configuring Secondary Radio Talkgroup Mute Operation.....	3-3
3.1.4	Enabling Secondary Radio Transmission	3-4
3.1.5	Configuring Cross Band Mute Operation	3-5
3.1.6	Enabling Fixed Swap Menu.....	3-6
3.1.7	Configuring Menu Swap	3-6
Chapter 4	Troubleshooting	4-1
4.1	Power-Up Errors.....	4-1
4.1.1	Missing Radio.....	4-1
4.1.2	Improper Radio Combinations.....	4-1
4.1.2.1	Secondary Radio FL 01-90 Scenarios	4-1
4.1.3	Control Head ID Error.....	4-2
4.1.4	Software Mismatch.....	4-2
4.1.5	General Radio Error	4-2
4.2	Error Display.....	4-3
Chapter 5	APX Dual-Radio Installation	5-1
5.1	Installation Planning	5-1
5.2	Trunk Units	5-2
5.2.1	Radio Mounting	5-2
5.2.1.1	Side-By-Side Installation	5-2
5.2.1.2	Stack Mount Installation	5-2
5.2.1.3	Dual-Radio Combined Audio Configuration	5-3
5.2.2	Cables	5-4
5.2.2.1	APX Dual-Radio Cables	5-4
5.2.2.2	Power and Ground Cables	5-4
5.2.2.3	Ignition Cable	5-5
5.2.2.4	Dual-Radio Accessory Cable	5-6
5.3	Installation Considerations	5-6
5.4	Power Connections	5-6
5.5	APX Dual-Radio O7 Control Head Cable.....	5-6
5.6	Operator Compartment Units	5-7
5.6.1	Quick-Disconnect Connector.....	5-7
5.6.2	Speaker Mounting	5-7
5.6.3	Microphone Hang-Up Clip.....	5-7
5.6.4	Emergency Footswitch	5-7
5.7	Antenna Mounting	5-7

Appendix A Other Configurations..... A-1

A.1 Converting to a Single-Radio System A-1
A.2 Changing the Control-Head Type..... A-1
A.3 Converting Radios Equipped With Dual-Radio Software into an APX Dual-Radio System A-1
A.4 Converting Radios Not Equipped With Dual-Radio Software into an APX Dual-Radio System.... A-1

Notes

List of Figures

Figure 2-1. APX Mobile Dual-Radio System Cabling Interconnect Diagram For O7 Remote Mount	2-1
Figure 2-2. O7 Control Head.....	2-2
Figure 2-3. Primary Radio Selected Diagram	2-8
Figure 2-4. Secondary Radio Selected Diagram	2-8
Figure 3-1. Enabling the APX Dual-Radio as Primary or Secondary Radio	3-1
Figure 3-2. APX Dual-Radio Emergency Mode Operation Configuration	3-3
Figure 3-3. Secondary Radio Talkgroup Mute Operation Configuration	3-4
Figure 3-4. Enabling Secondary Radio Transmission.....	3-5
Figure 3-5. Cross Band Mute Operation Configuration.....	3-5
Figure 3-6. Enabling Fixed Swap Menu.....	3-6
Figure 3-7. Menu Swap Configuration	3-6
Figure 5-1. Side By Side Installation For APX Mobile Mid-Power Dual-Radio O7 Control Head System.....	5-1
Figure 5-2. Side By Side Installation For APX Mobile High-Power Dual-Radio O7 Control Head System.....	5-1
Figure 5-3. Stack Mount Installation For APX Mobile Mid-Power Dual-Radio O7 Control Head System.....	5-3
Figure 5-4. APX Mobile Mid-Power Dual-Radio, Dual-Radio Combined Audio Configuration.....	5-4
Figure 5-5. APX Mobile Dual-Radio System Cabling Interconnect Diagram For O7 Remote Mount	5-5
Figure 5-6. Dual-Radio Accessory Cable Diagram	5-6

Notes

List of Tables

Table 1-1. APX Dual-Radio Detailed Interactions.....	1-1
Table 4-1. APX Mobile Dual-Radio Power-Up Self-Check Error Codes.....	4-2

Related Publications

This manual includes only information specific to APX Dual-Radio configuration. For more detailed information on APX Mobiles, please refer to the documents listed below.

ASTRO APX Mobile O7 Control Head User Guide	68012006034
ASTRO APX Mobiles O2, O3, O5, O7 & O9 Control Head Installation Manual	6878215A01
ASTRO APX Mobile Radios & O2, O3, O5, O7 & O9 Control Head Basic Service Manual.....	6875964M01
ASTRO APX 7500 Mobile Radio O2 & O7 Control Head Detailed Service Manual	68012006086
CPS Programming Installation Guide	6881095C44
KVL 3000 User's Manual.....	6881131E16
System 9000 Direct Entry Keyboard Instruction Manual	68P80101W22

Notes

Chapter 1 Introduction

1.1 General

A typical ASTRO® APX Mobile Dual-Radio O7 Control Head System configuration allows two APX Mobile radios known as the “bricks” to operate together with a single O7 Control Head.

The APX Dual-Radio only supports APX7500, APX6500, and APX6500Li transceivers, and it allows users to mix and match models across tiers and power levels. For example, an APX7500 High-Power radio can operate with an APX6500 Mid-Power radio.

The APX Dual-Radio supports both High-Power and Mid-Power radios, both In-Band and Cross-Band combinations, and four different frequency bands (7/800 MHz, VHF, UHF R1 and UHF R2).

When equipped, typical features such as Scan, Secure, DTMF Hot Keypad, Volume Control, Radio Selection, Push-To-Talk, and Monitor will be accessible through the O7 Control Head System.

Refer to [Table 1-1](#), for detailed interactions between the two radios.

Table 1-1. APX Dual-Radio Detailed Interactions

	Type	Example	Cross-Band	In-Band
Simultaneous Rx	Voice	Receive audio on both radios simultaneously.	Supported	Supported
Simultaneous Tx	Voice	Press PTT, and have the audio transmitted simultaneously on both radios.	Not Supported	Not Supported
	Data	Both radios can send out GPS coordinates simultaneously.	Supported	Not Supported
	Voice + Data	When pressing PTT on the selected radio to transmit voice, the unselected radio can send out GPS coordinates.	Supported	Not Supported
Simultaneous Rx & Tx	Voice	When pressing PTT on the selected radio to transmit voice, the unselected radio can receive audio and unmute its speaker.	Configurable	Not Supported
	Data	When the selected radio is receiving OTAR key, the unselected radio can send out rekey request.	Supported	Not Supported
	Voice + Data	When the selected radio is receiving voice, the unselected radio sends GPS coordinates. When the selected radio is transmitting voice, the unselected radio can receive OTAR keys.	Supported	Not Supported

APX Dual-Radios are considered to be “In-Band” when at least one frequency band of one radio overlaps with any one band of the other radio (single or dual band). APX Dual-Radios are considered to be “Cross-Band” when entirely different frequency bands exist for the two radios (single or dual band). This is based on each radio’s available frequency band(s), Primary Frequency Band and Secondary Frequency Band, regardless of the frequencies being used in each radio’s codeplug.

NOTE: Due to potential frequency band overlap, the combination of “UHF1” and “UHF2”, on APX Dual-Radio is considered as “In-Band”. When the radios are “In-Band”, due to potential RF interference, the functionality of one of the radio is limited when the other radio is transmitting.

1.1.1 APX Dual-Radio Software

The APX Dual-Radio option is supported by mobile host firmware release R12.00.00 or greater, supports the APX Customer Programming Software (CPS) and Tuner Software.

1.2 Ordering Information

One radio must be ordered with the Primary Radio option, and the other with the Secondary Radio option. Each radio is ordered independently and can be ordered with different options.

An audio combiner (P/N YLN4713_) can be ordered as an option on the Primary Radio, to allow customers to combine the audio from both transceivers into one headset or speaker.

Customers can order a Stack Mount Trunnion (P/N HLN7045_) as an option in the Primary Radio to allow them to easily mount the two radios, only when they are both Mid-Power models.

The APX Dual-Radio is incompatible with the RF Modem, DVRS MSU or PSU functionality.

The APX7500, APX6500, or APX6500Li radios can be ordered from the factory with the Dual-Radio options. Meanwhile APX6500Li radios can be ordered with an O7 Control Head only when the Dual-Radio software is ordered. The APX Dual-Radio option is available for APX7500, APX6500 and APX6500 Li field upgrades, by purchasing FLASHport[®] upgrade and additional hardware (see [Appendix A.4](#)).

1.3 Notations Used in This Manual

Throughout the text in this publication, you will notice the use of notes, cautions, and warnings. These notations are used to emphasize that safety hazards exist, and care must be taken and observed. Because some notations do not apply to information found in this manual, they are not used.

NOTE: An operational procedure, practice, or condition that is essential to emphasize.



Caution

CAUTION indicates a potentially hazardous situation which, if not avoided, might result in equipment damage.



WARNING

WARNING indicates a potentially hazardous situation which, if not avoided, could result in death or injury.



DANGER

DANGER indicates an imminently hazardous situation which, if not avoided, will result in death or injury.

You might also find in this manual the use of the asterisk symbol (*) to indicate a negative or NOT logic true signal.

Notes

Chapter 2 APX Mobile Dual-Radio Operation

2.1 Overview

The APX Dual-Radio contains two APX Mobile radios, single O7 Control Head, two speakers, and associated cabling (see [Figure 2-1](#)). The APX Dual-Radio configuration allows one control head to control two radios. One radio is designated as the Primary Radio, while the other is designated as the Secondary Radio.

Only one radio is accessible from the control head at any one time. The accessible radio is referred to as the Selected Radio, while the other radio is referred to as the Unselected Radio. The O7 Control Head indicators and display always reflect the state of the Selected Radio. In general, button presses like Push-to-Talk (PTT) only affect the Selected Radio, unless otherwise noted throughout this document. The Unselected Radio is normally in the receive, scan, or emergency state.

Customers connect the two APX Mobile radios to each other via a short CAN cable, and connect an O7 Control Head to one of the radios.

One speaker connects to the O7 Control Head and plays audio from the Primary Radio, and another speaker connects to the Secondary transceiver via a speaker extension cable and plays audio from the Secondary Radio.

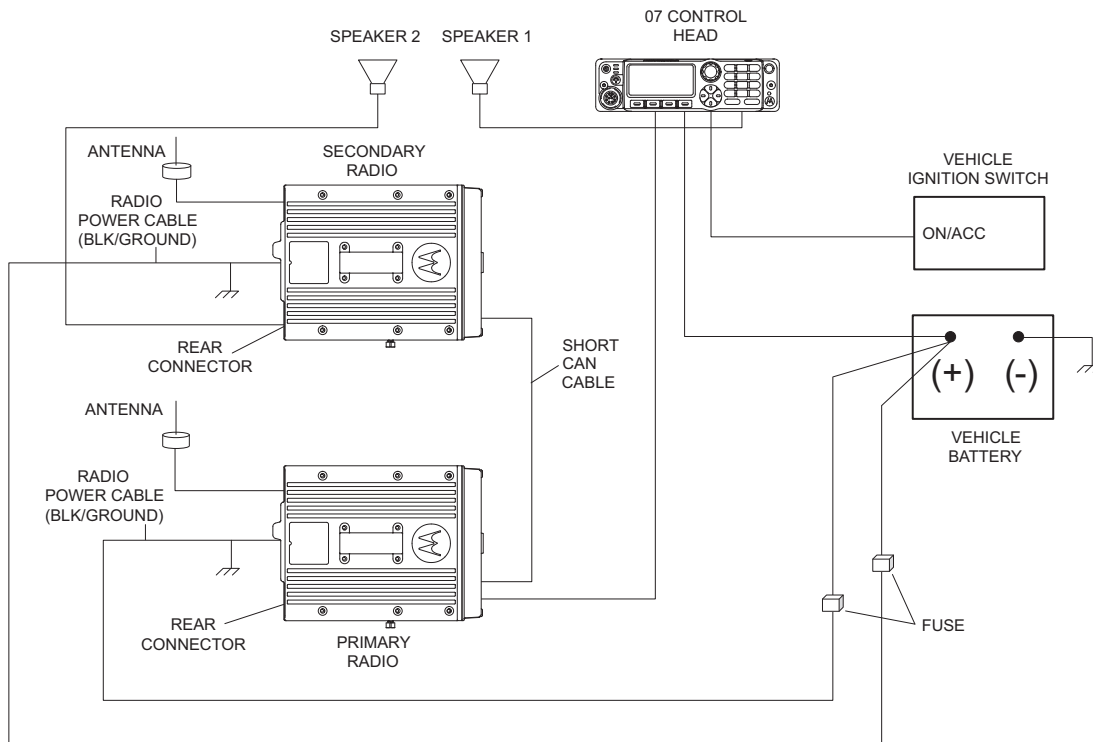

Figure 2-1. APX Mobile Dual-Radio System Cabling Interconnect Diagram For O7 Remote Mount

2.2 Initial Radio Setup

Refer to [Appendix A, "Other Configurations,"](#) on page A-1, for detailed initial radio setup.

2.3 O7 Control-Head Operation

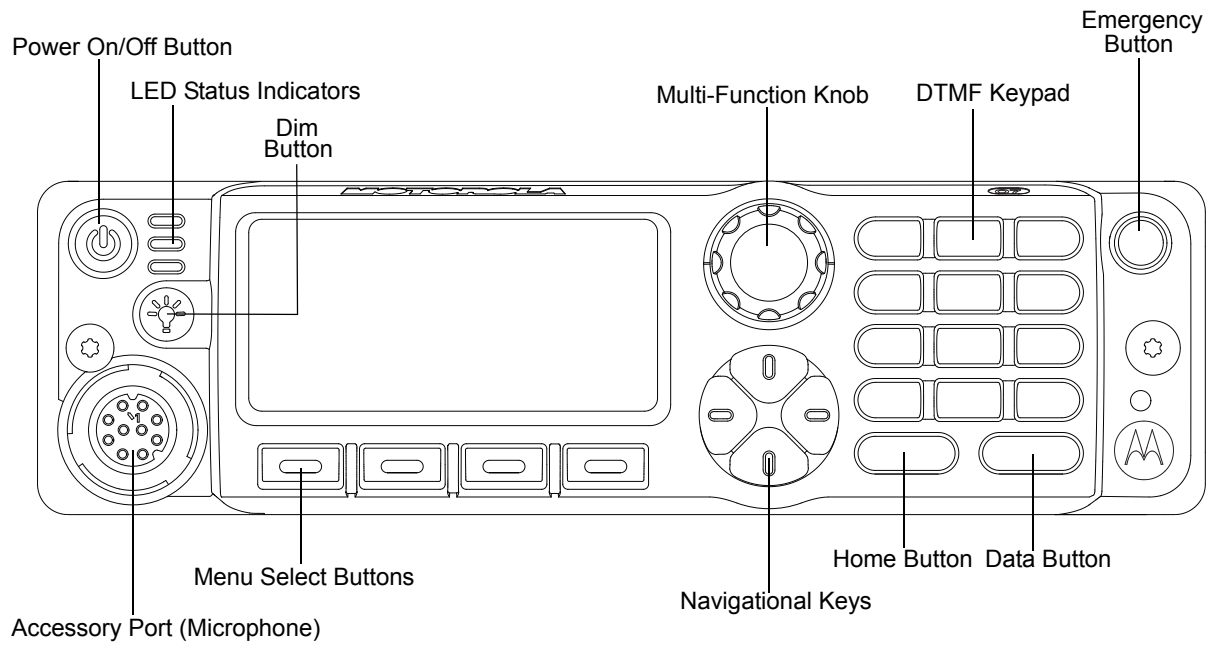

Figure 2-2. O7 Control Head

The O7 Control Head (Figure 2-2) is used to control both radios. Refer to the O7 Control Head User's Guide (68012006034) for detailed information regarding the use and operation of the APX Mobile Radio with the O7 Control Head. All radio features which are normally accessible with a O7 Control Head, are supported in a APX Dual-Radio System unless otherwise noted in this manual.

2.3.1 Display

The display shows the status of the currently selected mobile radio. When a radio is selected, all of its displays and indicators will be seen on the control head. When a radio is unselected, the displays and indicators associated with it other than the transmit indicator, are not seen.

2.3.2 Basic Radio and Control Head Control

In general, button presses only affect the Selected Radio, unless otherwise noted throughout this document, but the switch input may affect both radios. The Unselected Radio is not accessible via the control head until the user changes the radios. The following are examples of the operation and its effects on the respective radio:

- The Push-to-Talk (PTT) only affects the selected radio
- The ignition sense and VIP inputs affects both radios
- The HUB input only affects the selected radio, while the unselected radio always assumes HUB is on hook

2.3.3 Backlight

Any programmable buttons that are configured for "DIM" must be configured for "DIM" on both radios. This button press allows the radio user to change the illumination level of the radio's backlight.

2.3.3.1 Intelligent Lighting

Intelligent lighting is turned off on the control head when radio swap occurs, as the control head reflects the status of the newly selected radio. Switching to the other radio will not shutdown the intelligent lighting on the previously selected radio. Once switched back, the intelligent lighting automatically resumes if it is still active.

2.3.4 Volume Operation

The volume on each radio is controlled independently, and can be set at different levels.

It is required to configure the MFK and Volume Up/Down feature the same on programmable buttons on both radios, to launch two radios.

2.4 Feature Operation

The following section describes the features available for the APX Mobile Dual-Radio System O7 Control Head System.

2.4.1 APX Dual-Radio Indication

As there is only one control head, but two radios, an indication of which radio is selected and which radio is receiving is provided at any given moment. The split screen is used to indicate the status of both radios in system. The APX Dual-Radio icon represents the selected radio, and shows the different states of the receiving radio. The receiving icon on the vertical banner indicates that the unselected radio is receiving, and user needs to do Radio Swap to talk. Refer to Section 2.8, "APX Dual-Radio User Interface," on page 2-8, for more details on the APX Dual-Radio Indications.

2.4.2 Radio Swap

Radio Swap allows user to toggle between the Primary Radio and the Secondary Radio.

As there is only one control head connected in the system, the control head only reflects the display info of the currently selected radio. In order to select and operate the other radio, it is required to do Radio Swap first.

- After Radio Swap, the O7 Control Head reflects the status of new selected radio.
- Radio Swap can be configured on any of the menu buttons on the O7 Control Head, any programmable button on the O7 Control Head or keypad mic (except the DTMF keypad), or on any DEK button.
- If the Fixed Swap Menu is enabled in CPS, the Radio Swap Menu is automatically assigned the leftmost menu position, regardless of how a user scrolls the menu list. While both the "Fixed Swap Menu" is enabled in CPS and the "Radio Swap" is configured in menu list, then only the fixed swap menu shall be displayed.
- When the Radio Swap Button is long pressed, the O7 Control Head displays the selected radio alias temporarily if radio alias is enabled in codeplug.
- If the PTT button is pressed and held, Radio Swap is not allowed.

2.4.3 PTT Operation

When the PTT button is pressed, only the Selected Radio will key up. A Radio Swap will not be allowed, when pressing PTT. While the radio is unselected and it receives transmit request from a third party device, the request will be ignored.

NOTE: a) Simulcast operation, where both radios transmit simultaneously, is not supported.
b) If the APX Dual-Radio is on “In-Band” combination, and the selected radio is transmitting, the unselected radio’s speaker is muted.
c) If the APX Dual-Radio is on “Cross-Band” combination, and the selected radio is transmitting, customers can configure the unselected radio’s speaker to either mute or unmute.

2.4.4 Emergency Operation

Emergency is able to launch on the selected radio, or on a pre-defined Emergency Radios (either Primary Radio or Secondary Radio). A codeplug field is provided to configure which radio will launch emergency, with three options as follows:

- a. Selected Radio: Emergency shall launch on the currently Selected Radio, and cannot be launched on both radios simultaneously. Thus, it is required to exit Emergency on the first radio, in order to launch Emergency on the other radio. A long press of the emergency button can only exit emergency, while the emergency radio is selected.
- b. Primary Radio: Emergency will launch on the Primary Radio, regardless of which radio is selected. If the Primary Radio is not selected, Radio Swap will automatically occur to ensure it is selected. A long press of the emergency button can exit emergency, regardless of which radio is selected.
- c. Secondary Radio: Emergency will launch on the Secondary radio, regardless of which radio is selected. If the Secondary Radio is not selected, Radio Swap will automatically occur to ensure it is selected. A long press of the emergency button can exit emergency, regardless of which radio is selected.

Radio Swap is allowed while the radio is in the Emergency Call Mode, but Radio Swap is inhibited when the radio is in the Emergency Alarm, Emergency Hot Mic, or Silent Emergency State.

2.4.5 Radio Wide Features

Siren/PA, Light Bar, Gun Lock, Aux Control, DIM and Day/Night Mode are radio wide features. Regardless of which radio is selected, customers can launch these features by pressing the related buttons. The Radio Swap operation will not change the status of these features.

The programmable button configuration of radio wide features shall be the same on both radios.

2.4.5.1 Siren

- Siren can only connect to Primary Radio. No matter which radio is selected, Siren/PA can be launched if Siren/PA button is pressed.
- External radio only works on Primary Radio, it can only route the Primary Radio audio to siren speaker.

2.4.5.2 Light Bar

- Light Bar only connects to Primary Radio.
- Light bar is accessible regardless of which radio is selected.

2.4.5.3 Gun Lock

- Gun Lock is accessible regardless of which radio is selected.

2.4.5.4 Aux Control

- Aux Control operation can be activated by the radio user, regardless of which radio is selected.
- The Aux Control state shall not be changed after Radio Swap in Dual-Radio System.

2.4.6 Advanced Unmute Rule

For APX Dual Radio In-Band combinations, when one radio is transmitting voice, the other radio will automatically mute but can still play tones and Voice Announcement.

For APX Dual Radio Cross-band combinations, customers are given the option of having the other radio mute or remain unmuted. If the “Cross-Band Mute Option” field is checked in CPS, the other radio will mute automatically when the Selected Radio transmits voice. Refer to Section 1.1, “General,” on page 1-1 for detailed interactions between the two radios in “In-Band” and “Cross-Band” combinations.

If both radios are on the same trunking talkgroup and the “Talkgroup Mute Option” is set to “Always Mute” in CPS, the Secondary radio will automatically mute when the Primary radio receives audio. The Secondary Radio will still play tones and Voice Announcement. If the “Talkgroup Mute Option” is set to “Never Mute”, both radios will play the same audio. Refer to Section 3.1.3, “Configuring Secondary Radio Talkgroup Mute Operation,” on page 3-3 for detailed Secondary Radio Talkgroup Mute Operation.

2.4.7 Radio Inhibit

Selective Radio Inhibit allows the dispatcher to deny an individual access to the radio system by sending a Selective Radio Inhibit Command to the radio. In an APX Dual-Radio System, both radios need to be inhibited or uninhibited together.

- When one radio is inhibited, the other radio shall become uninhibited.
- When both radios are in an inhibited state, and one radio is uninhibited, the other radio shall become uninhibited.

2.4.8 Over-The-Air Rekeying (OTAR)

Both radios (if equipped) are capable of supporting OTAR. The OTAR System can direct rekeys to either radio in the Dual-Radio System, one radio at a time. User initiated rekey requests are for the Selected Radio only. In order to rekey both radios, the user will first initiate a rekey request on the Selected Radio. Once there is a successful rekey, the user can then change the Selected Radio using the Radio Swap Button. The user can then initiate a rekey request for the newly Selected Radio.

Successful OTAR rekeys on conventional channels are associated with tone and display indications. Successful OTAR rekeys on trunking channels are associated with a tone indication.

2.4.9 Audio

If an audio recorder connects to the control head, then it can only record the transmitting and receiving audio of the Primary Radio. It cannot record any audio from the Secondary Radio.

If the audio recorder connects to the brick TIB(J600), then it can only record the audio of this radio.

2.4.10 Radio Profile

In Dual-Radio system, when tone is disabled on the Selected Radio by profile, the tone shall also be disabled on the Unselected Radio. While tone is enabled on the Selected Radio by profile, the tone shall also be enabled on the Unselected Radio.

While the profile is selected manually via profile configuration window, the selection applies to all the channels which uses the last user selected profile on both radios.

A Radio Swap works as a channel change, where the profile of the newly selected radio gets automatically refreshed. While the newly selected radio uses the last user selected profile, the tone and light follows the setting of the last profile selected by user manually. While the newly selected radio uses strapped profile, the tone and light gets refreshed based on the CPS setting of this profile.

2.4.11 Model Display

While powering up, the O7 Control Head displays the model of the radio, for example APX7500, APX6500 or APX6500 Li. For APX Dual-Radio, it only displays the model of the Primary radio.

2.4.12 Data Terminal

Data terminals can connect either to the transceiver or to the control head. If connected to the control head, the data terminal sets up a connection with the Primary Radio only.

2.5 Hot Red Receiver (HRR) Solution

The "Enable Secondary Radio Tx" CPS field on the Secondary Radio is to configure whether this radio has transmission capability. While this field is disabled, the APX Dual-Radio system works the same as the HRR solution of the ASTRO Spectra radio. If the "Enable Secondary Radio Tx" field is disabled, then the Secondary Radio cannot transmit, but it can still receive group call without registering to the trunking system. It can only support Smartnet, SmartZone and Smartzone, and Ommilink System.

- Secondary Radio is able to receive group call and announcement group call, even if the radio cannot transmit at all.
- Secondary Radio does not support Data and Call related features, as it doesn't have a valid individual ID.
- Secondary Radio does not support OTAR, it is required to load key manually.
- Secondary Radio does not support voice call monitoring on an ISSI (inter-WACN roaming) and Intra-WACN roaming system.
- Secondary Radio does not support voice call monitoring on a Non-Motorola system.
- If the trunking system is configured to use a TDMA voice channel, customer needs to ensure the Secondary Radio has TDMA capability and TDMA is enabled.

2.6 Button Configuration

It is recommended that the user configures all the programmable buttons the same on both radios, in order for the APX Dual-Radio System to achieve seamless interoperability.

NOTE: User can utilize the drag and drop functionality, to drag button configuration from one radio to the other in CPS.

Radio wide features including Siren, Light Bar, Aux Control, Gun Lock and DIM, and Emergency feature must be configured the same on programmable buttons on both radios.

2.7 Programming

For CPS programming, a Primary Radio or a Secondary Radio can be powered independently in a standalone configuration, or can be connected in an APX Dual-Radio System. When connected in an APX Dual-Radio System, the radios cannot be programmed simultaneously. When one radio enters program mode, the other radio will not be allowed to enter program mode until the Dual-Radio System resets. Only the Primary Radio can be programmed using a data cable connected to the control head. The Secondary Radio must be programmed with a data cable connected directly to the Secondary Radio transceiver.

2.7.1 FLASHport[®] Upgrade

It is recommended to upgrade the radios without being connected to each other. When they are connected together, the radios behaviors are as follows:

- a. While upgrading the Primary Radio, there will be multiple resets and the control head will show the Secondary Radio's channel or zone text intermittently at the beginning.
- b. While upgrading the Secondary Radio, there will be multiple resets and the control head will show the Primary Radio's channel or zone text intermittently at the beginning. Then the control head will show the "Secondary Updt" string to indicate secondary updating.

2.8 APX Dual-Radio User Interface



Figure 2-3. Primary Radio Selected Diagram

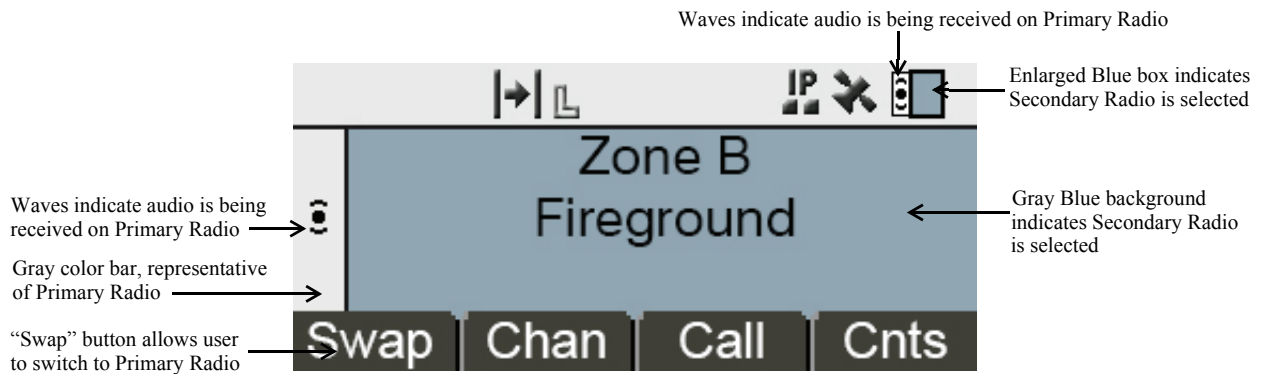

Figure 2-4. Secondary Radio Selected Diagram

Chapter 3 Codeplug Configuration

3.1 Overview

Following are the codeplug setting instructions, for configuring a mobile radio to function as part of the APX Dual-Radio System. Using CPS, the APX Dual-Radio options can be enabled in the **Radio Configuration->Radio Wide->Dual Radio** screen.

3.1.1 Enabling APX Dual-Radio as Primary or Secondary Radio

In a Dual-Radio configuration, the radio selection determines which radio is the “Primary Radio” and the “Secondary Radio”. Radio switching between the two radios is initiated with a Radio Swap button press or a Radio Swap menu-selection.

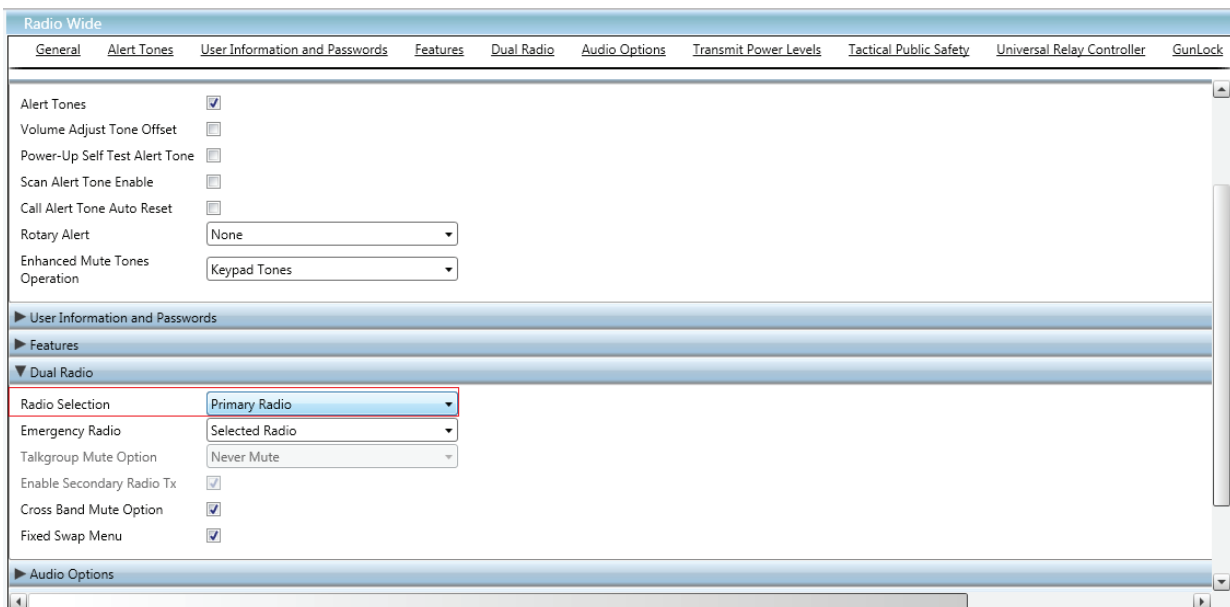

Figure 3-1. Enabling the APX Dual-Radio as Primary or Secondary Radio

There are three options available for the Radio Selection field:

1. Standalone Radio - Selects the current radio to operate the same as a single radio, even though the APX Dual-Radio option is present.
2. Primary Radio - Selects the current radio to be the first radio used by the control head upon Dual-Radio power up. This is why the Ignition Switch feature must be programmed for this radio, which determines power on and power off for the Dual-Radio system.

NOTE: Radio Wide features such as the PA/Siren and the Universal Relay Controller are CPS-defined for this radio codeplug only. Additionally all external hardware devices for these features must be connected to the Primary Radio.

3. Secondary Radio - Selects the current radio to be the Second Radio used by the control head.

3.1.2 Configuring APX Dual-Radio Emergency Operation

User selects which radio in a Dual-Radio configuration will handle the Emergency Mode Operation. It could be either the currently selected radio or the pre-determined Primary or Secondary Radio. This feature applies on a radio-wide basis.

This can only be accessed, when the Radio Selection field is set to Primary Radio.

NOTE: Only the Primary Radio can configure the radio that shall be used to initiate the Emergency Operation, and the Secondary Radio shall always follow the setting of the Primary Radio.



WARNING

For Emergency Evacuation Tone to be enabled in Dual-Radio configuration, while Emergency is programmed on the Orange Button, Evacuation Tone must be programmed as follows:

When the Emergency Radio choice is:

- “Selected Radio”, Evacuation Tone has no “Orange Button” restrictions and can be programmed on both radios, or on either radio as needed.
- “Primary Radio”, Evacuation Tone must be programmed on the Primary Radio.
- “Secondary Radio”, Evacuation Tone must be programmed on the Secondary Radio.

The Emergency Mode “Radio Swap” Rule For All Emergency Radio Selections:

When one of the radios is in Emergency Mode, and it is in the Emergency “Call” State, a Radio Swap button-press and/or a Radio Swap menu-selection is possible. However, Radio Swap is not possible when the radio is in the Emergency Alarm State, and/or Radio Swap is not possible when that radio’s channel is in the “Hot Mic” or “Emergency via Silent Audio” state mode.

The Emergency Mode “Silent Alarm” and “Unmute Option” Rule For All Emergency Radio Selections:

When the Selected Radio is in Silent Alarm - Emergency Mode, both the Selected Radio and the Unselected Radio follow the Unmute Option setting of the Selected Radio.

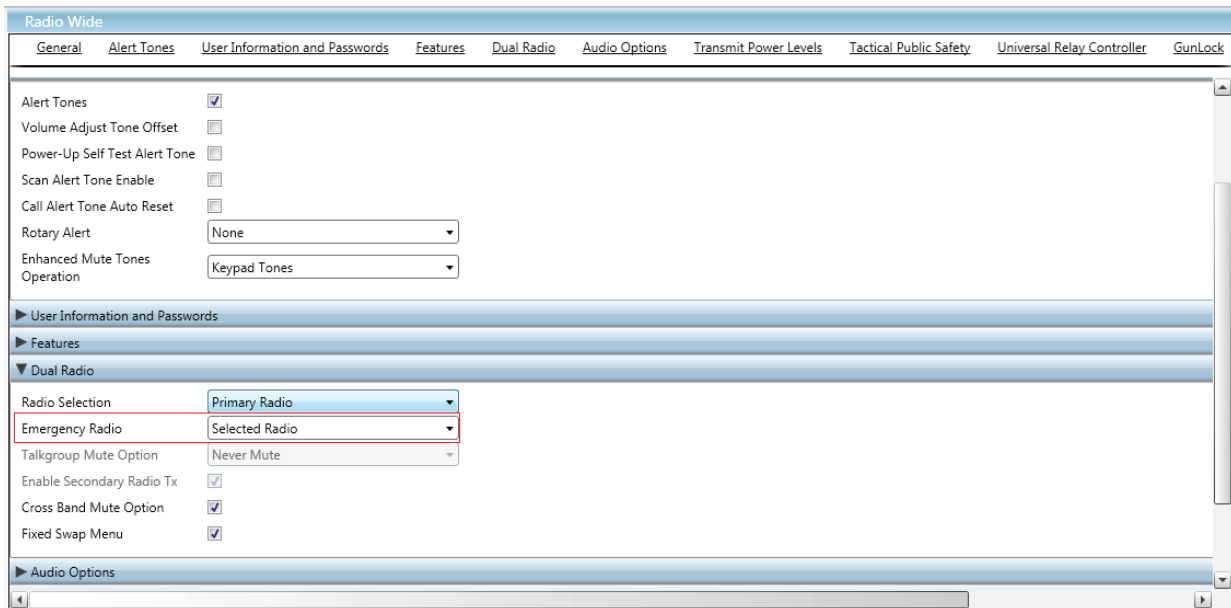

Figure 3-2. APX Dual-Radio Emergency Mode Operation Configuration

There are three selections for the Emergency Radio as follows:

1. Selected Radio - When Emergency Mode is activated, the emergency transmission is sent on the currently user selected radio.

NOTE: Both radios cannot enter Emergency Mode at the same time. Therefore Emergency must be exited on one radio, before it can be initiated on the other radio. Exiting Emergency Mode is accomplished with the normal methods.

2. Primary Radio - When Emergency Mode is activated, the emergency transmission is always sent on the Primary Radio.

NOTE: If emergency is activated and the Primary Radio is not the currently Selected Radio, the radios are automatically swapped making the Primary Radio the Selected Radio, and then emergency is transmitted. Exiting Emergency Mode is accomplished with the normal methods.

3. Secondary Radio - When Emergency Mode is activated, the emergency transmission is always sent on the Secondary Radio.

NOTE: If emergency is activated and the Secondary Radio is not the currently selected radio, the radios are automatically swapped making the Secondary Radio the Selected Radio, and then emergency is transmitted. Exiting Emergency Mode is accomplished with the normal methods.

3.1.3 Configuring Secondary Radio Talkgroup Mute Operation

User selects Dual-Radio Trunking dispatch rule that determines when the Secondary Radio mutes and unmutes its speakers. This is only true when both radios are programmed with an identical Trunking Talkgroup (based on the Talkgroup ID), and/or Announcement Group (based on the Announcement Group ID), regardless of which Talkgroup(s) for these radios are operating in the field.

This can only be accessed when the Radio Selection field is set to Secondary Radio.

Following are the two selections for Secondary Radio Talkgroup Mute Operation:

1. Never Mute - The Secondary Radio mutes or unmutes according to normal group call operation, where muting is never forced.
2. Always Mute - The Secondary Radio remains muted when both radios are programmed with an identical Trunking Talkgroup (based on the Talkgroup ID), and/or Announcement Group (based on the Announcement Group ID), regardless of which Talkgroup(s) for these radios are operating in the field. However it can still unmute to individual calls such as Selective or Private Calls, Call Alerts or Pages, Phone Calls, Alert Tones and Voice Announcements.

NOTE: The Secondary Radio remains muted even when the Primary Radio is not able to unmute due to its normal unmute rules which are not being satisfied.

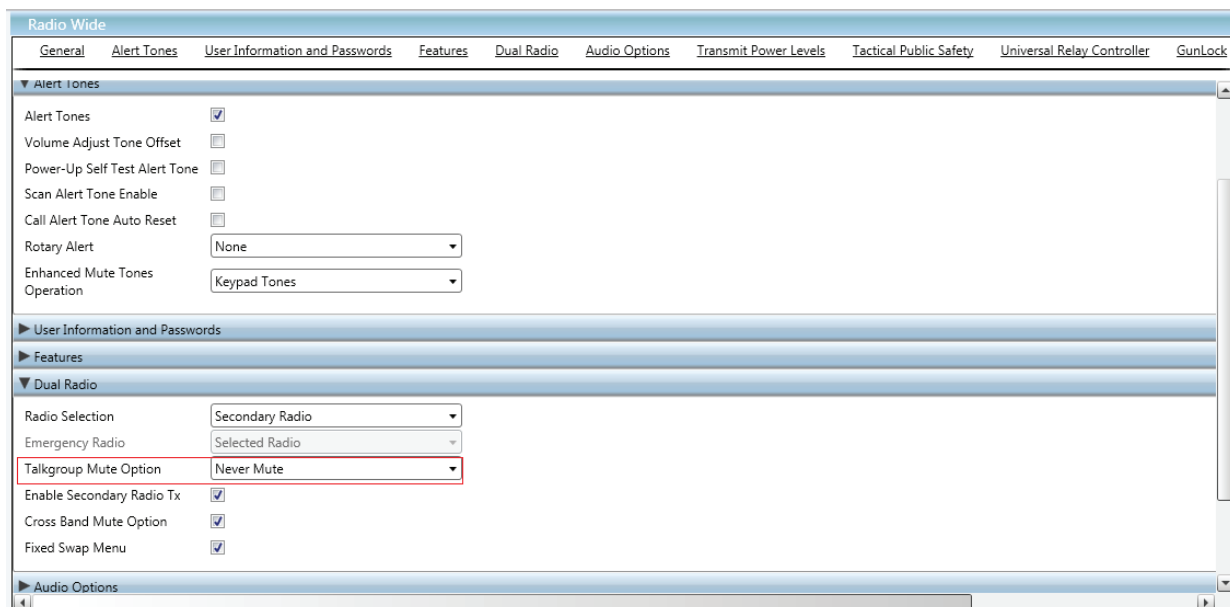

Figure 3-3. Secondary Radio Talkgroup Mute Operation Configuration

3.1.4 Enabling Secondary Radio Transmission

The APX Dual-Radio CPS provides the capability to enable and disable the Secondary Radio transmission. It allows the Secondary Radio in APX Dual-Radio to transmit on the current channel, and this feature works on a Radio Wide basis.

When the option is disabled, all transmissions from the Secondary Radio are disabled. Thus, the radio cannot roam, register and affiliate, but it can still unmute to receive calls. See Section 3.1.3, "Configuring Secondary Radio Talkgroup Mute Operation," on page 3-3 for Talkgroup Mute Operation.

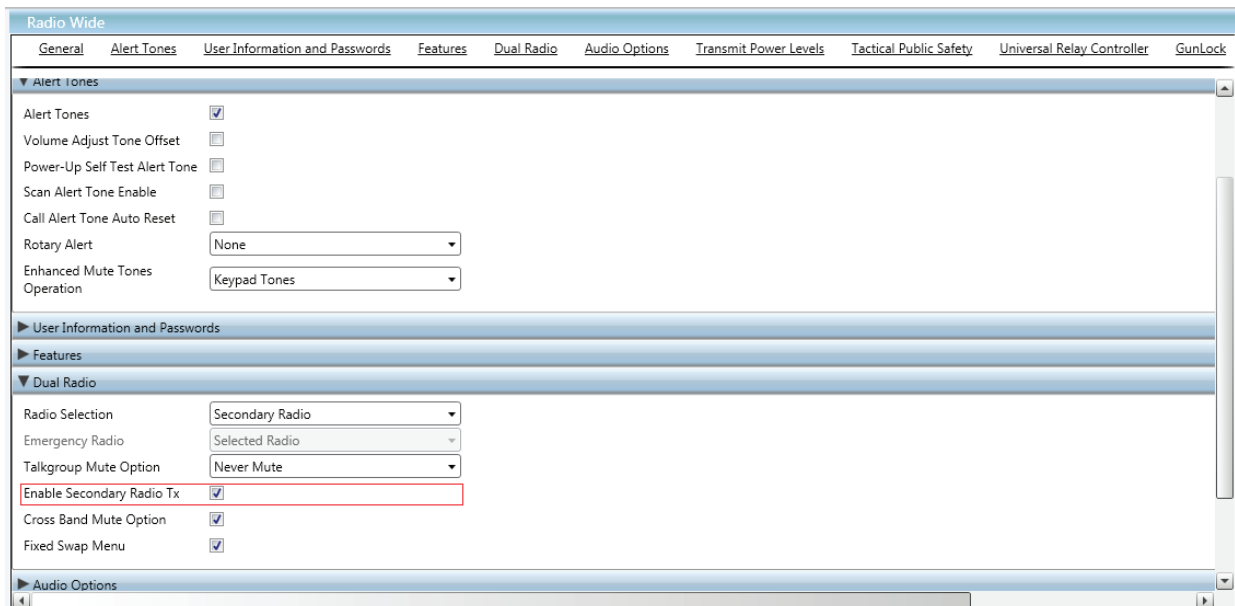

Figure 3-4. Enabling Secondary Radio Transmission

3.1.5 Configuring Cross Band Mute Operation

The Cross Band Mute Operation causes the speaker of the unselected radio in an APX Dual-Radio configuration to remain muted to receive audio, when the currently selected radio is transmitting voice and both radios are operating in a “cross-band” combination (operating in completely different frequency bands). This feature works on a Radio Wide basis.

When disabled, the unselected radio is still able to unmute to receive audio, when the currently-selected radio is transmitting in a “cross-band” combination.

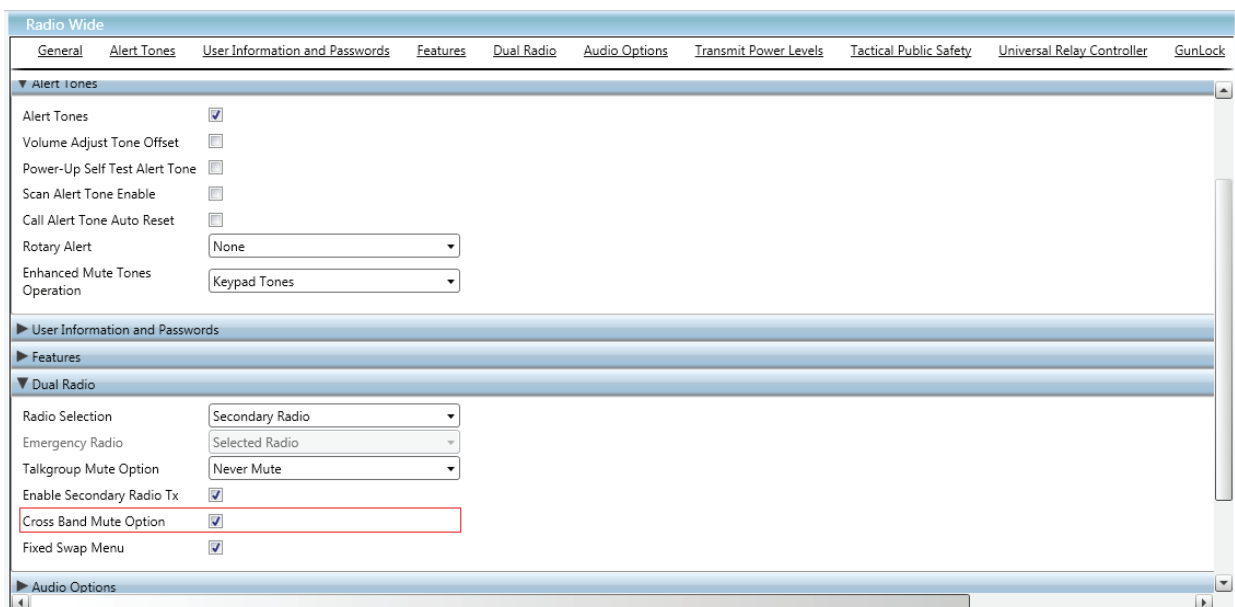

Figure 3-5. Cross Band Mute Operation Configuration

3.1.6 Enabling Fixed Swap Menu

Enables a “Radio Swap” menu selection to always appear in the left-most menu position of the control head in a Dual-Radio configuration, even when the radio user scrolls through the soft-menu buttons.

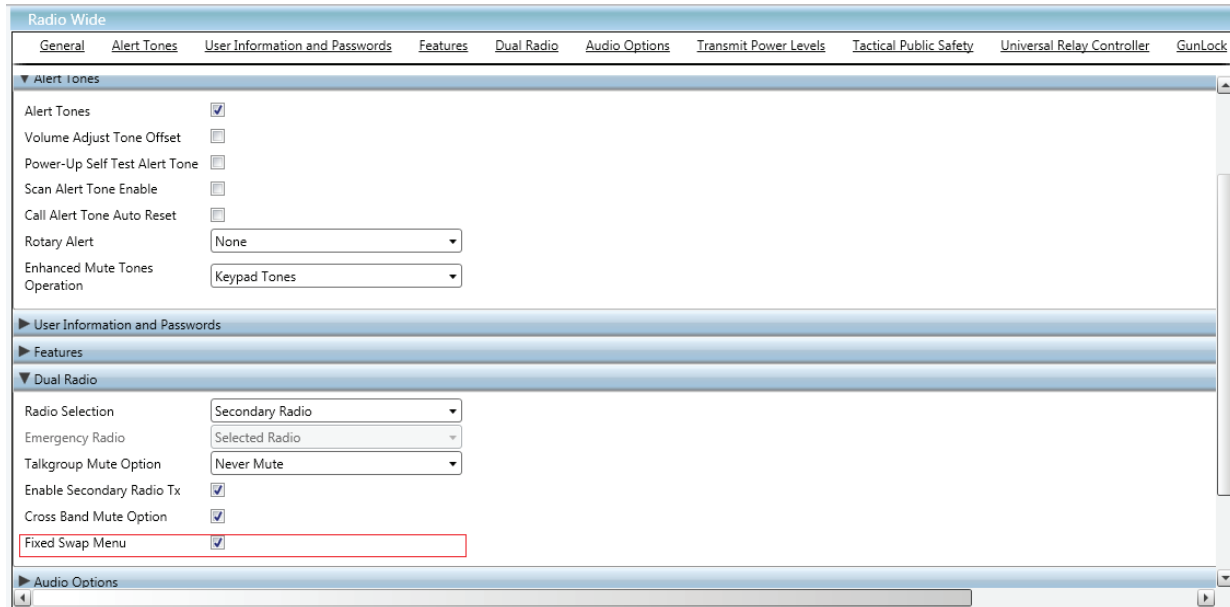

Figure 3-6. Enabling Fixed Swap Menu

3.1.7 Configuring Menu Swap

This menu selection allows user to swap back and forth between two radio bricks that are attached to the control head in a Dual-Radio configuration. This feature applies while operating in a Conventional or Trunking communication mode. Enabling this menu selection has no effect when "Fixed Swap Menu" is enabled.

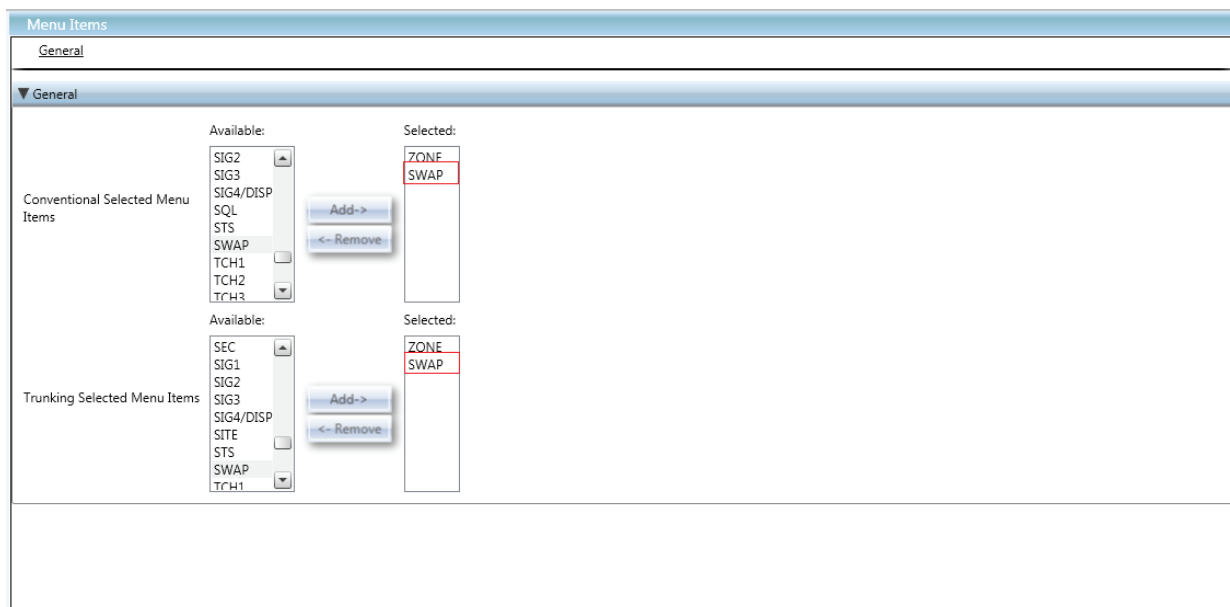

Figure 3-7. Menu Swap Configuration

Chapter 4 Troubleshooting

4.1 Power-Up Errors

In the event that there is a setup problem while powering up the system, the system attempts to notify the user of this problem by displaying power-up error messages as follows. The O7 Control Head displays power-up errors occurring in either radio.

Any power-up failure during the self-check routine will cause the associated radio to generate a Bad Key Tone.

4.1.1 Missing Radio

If one of the radios is not connected at power-up, an error message is displayed, and the remaining radio continues to function. For example, when only the Primary Radio is connected, it will show "Secondary missing", and when only the Secondary Radio is connected, it will show "Primary missing".

NOTE: While only one Primary or Secondary Radio is connected, customer is not recommended to rely on the radio, as its function shall be limited. In order to use the radio as a Standalone Radio, it is required to change the "Radio Selection" field to "Standalone Radio".

4.1.2 Improper Radio Combinations

If both radios go through improper radio configuration setup, "FL 01-90" is displayed to indicate a communication error with the control head has occurred. If the error cannot be recovered, the radio keeps resetting before it enters the maintenance mode. See [Chapter 3, "Codeplug Configuration"](#) for details on codeplug configuration. The improper APX Dual-Radio setup can have any of the following radio combination:

- two Primary Radios
- two Secondary Radios
- two Standalone Radios
- one Primary Radio with one Standalone Radio
- one Secondary Radio with one Standalone Radio

4.1.2.1 Secondary Radio FL 01-90 Scenarios

The first time a Secondary Radio is powered up without a Primary Radio attached, the Secondary Radio will reconfigure itself to communicate directly with the O7 Control Head. During this process, the control head will time out, displays a "FL 01/90" error message, and resets the radio. After the reset, the radio will power up with full single-radio functionality, but will permanently display the "Primary Missing" error message.

NOTE: The first time an APX Dual-Radio System is powered up, the Secondary Radio will reconfigure itself to communicate indirectly with the O7 Control Head. During this process, the control head will time out, displays a "FL 01/90" error message, and resets the radios. After the reset, the Dual-Radio System will power up successfully.

4.1.3 Control Head ID Error

The APX Dual-Radio only allows the O7 Control Head ID to be set to #1. If the ID is not set as required, "CH ID# ERR" shall be displayed and the radio is not able to function. User can use the control head Front Panel Programming feature to change the control head ID.

For setting and changing the Control Head ID Reference, refer to (Section 2.2.2.5, Setting the Initial Control Head ID) of the APX Mobiles And Control Heads Installation Manual (P/N 6878215A01).

4.1.4 Software Mismatch

Both radios shall have the same firmware version. If the firmware version does not match, the APX Dual-Radio system shall power up with fatal error, and "SW Mismatch" is displayed along with both radios firmware versions.

Both radios shall have the same language type. If the language type does not match, the APX Dual-Radio system shall power up with fatal error, and "Lang Mismatch" is displayed.

4.1.5 General Radio Error

When the radio is turned on (power-up), the radio performs cursory tests to determine if its basic electronics and software are in working order. Problems detected during these tests are presented as error codes on the radio's display. [Table 4-1](#) aids in understanding general power-up error code displays.

Table 4-1. APX Mobile Dual-Radio Power-Up Self-Check Error Codes

Error Code	Description	Error Type	Corrective Action
01/02 or 21/02	FLASH ROM Codeplug Checksum	Non-Fatal	Reprogram the codeplug
01/12 or 21/12	Security Partition Checksum	Non-Fatal	Send radio to depot
01/81 or 21/81	Host ROM Checksum	Fatal	Send radio to depot
01/82 or 21/82	FLASH ROM Codeplug Checksum	Fatal	Reprogram the codeplug
01/84 or 21/84	External EEPROM blank (or SLIC failure)	Fatal	Send radio to depot
01/88 or 21/88	External RAM Note: Not a checksum failure	Fatal	Send radio to depot
01/90 or 21/90	General Hardware Failure	Fatal	Turn the radio off, then on
01/92 or 21/92	Security Partition Checksum	Fatal	Send radio to depot
01/93 or 21/93	FLASHport Authentication Code Failure	Fatal	Send radio to depot
01/94 or 21/94	Internal EEPROM blank.	Fatal	Send radio to depot
01/98 or 21/98	Internal RAM Fail	Fatal	Send radio to depot
01/A2 or 21/A2	Tuning Codeplug Checksum	Fatal	Send radio to depot
02/81 or 22/81	DSP ROM Checksum	Fatal	Send radio to depot
02/88 or 22/88	DSP RAM Note: Not a checksum failure	Fatal	Turn the radio off, then on

Table 4-1. APX Mobile Dual-Radio Power-Up Self-Check Error Codes (Continued)

Error Code	Description	Error Type	Corrective Action
02/90 or 22/90	General DSP Hardware Failure (DSP startup message not received correctly)	Fatal	Turn the radio off, then on
09/10 or 29/10	Secure Hardware Error	Fatal	When equipped with the 3 day key retention option, make sure the radio had battery voltage applied for at least 2 minutes, then turn the radio off, then on. With no options, turn the radio off, then on
09/90 or 29/90	Secure Hardware	Fatal	Turn the radio off, then on
15/10	External Accessory External Accessory is not present on power up or did not power up correctly, and external accessory feature is enabled in codeplug	Non-Fatal	Verify external accessory is connected and powers up. Turn the radio off, then on
15/90	External Accessory External Accessory is not present on power up or did not power up correctly, and external accessory feature is enabled in codeplug	Fatal	Verify external accessory is connected and powers up. Turn the radio off, then on
Note: 01, 02, or 09 denotes a failure on the Primary Radio. 21, 22, or 29 denotes a failure on the Secondary Radio.			

See the *ASTRO APX Mobile Radios and Control Heads Basic Service Manual (P/N 6875964M01)* for all other error codes.

4.2 Error Display

If an Unselected Radio has an error, the error message shall be displayed on the status (third) line of the O7 Control Head with its associated banner.

The Primary Radio will display the error of the Secondary Radio during power up, as the Primary Radio is the Selected Radio by default.

- The Primary Radio Host error code is defined as 01/xx (legacy behavior)
- The Primary Radio DSP error is defined as 02/xx (legacy behavior)
- The Secondary Radio Host error is defined as 21/xx (new behavior)
- The Secondary Radio DSP error is defined as 22/xx (new behavior)

Notes

Chapter 5 APX Dual-Radio Installation

5.1 Installation Planning

The ASTRO APX Mobile Dual-Radio System consists of several different components (see [Figure 5-1](#) and [Figure 5-2](#)), and some preliminary planning should be completed before beginning actual system installation. The O7 Control Head, emergency footswitch, and speakers mount in the operator's compartment. It is recommended that the radios be mounted in the vehicle's trunk. Be sure the chosen locations for all housings do not expose the units to dirt or moisture.

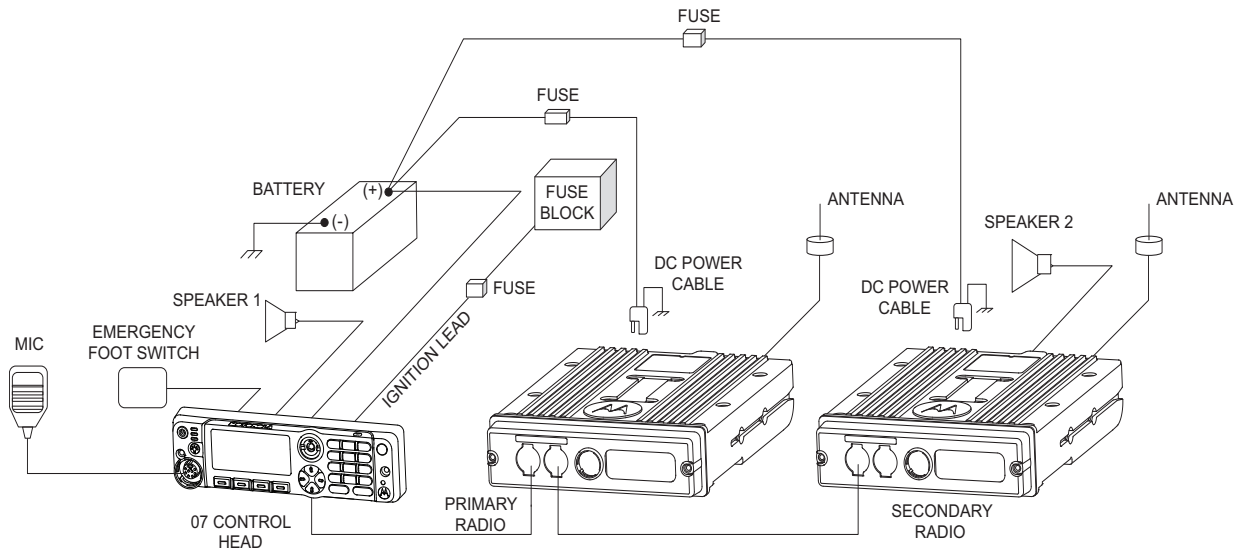

Figure 5-1. Side By Side Installation For APX Mobile Mid-Power Dual-Radio O7 Control Head System

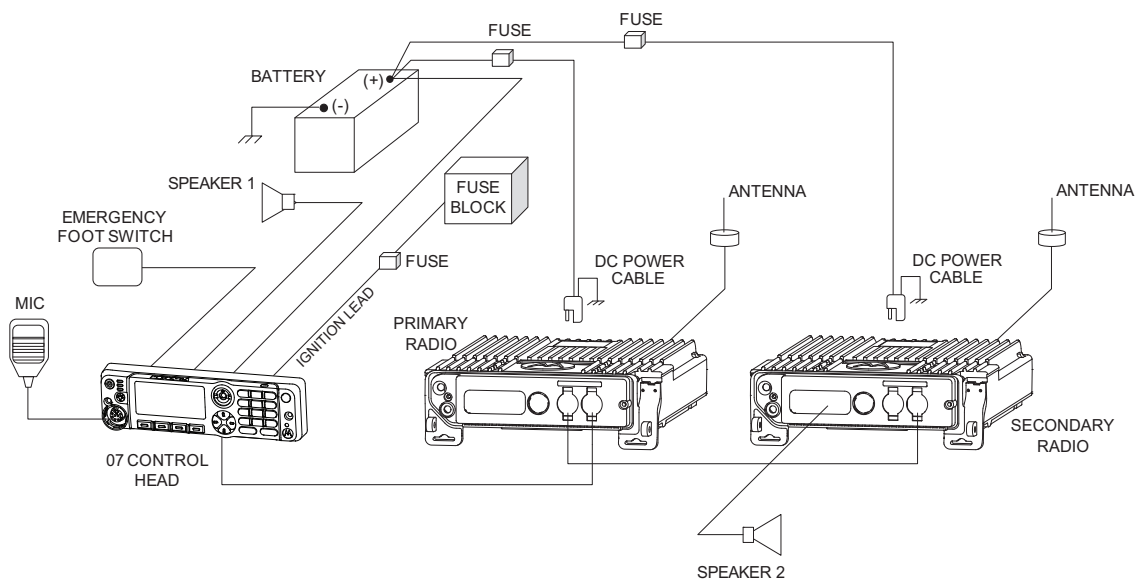

Figure 5-2. Side By Side Installation For APX Mobile High-Power Dual-Radio O7 Control Head System

5.2 Trunk Units

This section describes trunk unit installations.

5.2.1 Radio Mounting

The APX Dual-Radio System uses CAN bus to connect two radios and the O7 Control Head together. The Primary Radio connects directly to the Secondary Radio, and the Primary Radio connects directly to the control head. It is recommended that the control head connect to the Primary radio. There are two mounting styles which are “Stack Mounting” and “Side-By-Side Mounting”.

The Stack Mounting is only available for MP-MP combination, when both radios are Mid-Power models.

For the APX Mobile Radio Mounting, refer to (Section 2.2, Radio Mounting) of the APX Mobiles And Control Heads Installation Manual (P/N 6878215A01).

5.2.1.1 Side-By-Side Installation

[Figure 5-1](#) and [Figure 5-2](#) show a complete setup of APX Dual-Radio Side-By-Side Installation, for both Mid-Power and High-Power radios. Following are the installation procedures:

- Use the *Standard Trunnion* (P/N HLN7002_), for installing each radio.
- Mount the Primary and Secondary Radios on the Trunnions.

NOTE: Mark the Primary and Secondary Radios with the included P and S labels (P/N 54009321002). Marking the radios allows for proper setup.

- Connect the Accessory Connector (P/N HLN6863_) to both radios.
- Connect the DC Power Cables (P/N HKN4192_) to each radio. Connect the other end of the cables to the battery terminals (RED POSTITIVE).
- Install the O7 Control Head, refer to the APX Mobiles And Control Heads Installation Manual (P/N 6878215A01).
- Install two speakers (P/N HSN4031_).
- Connect the Primary speaker to the on-line connector on the control head power cable. Connect the Secondary speaker to the accessory connector on the Secondary Radio transceiver. Use the Speaker Extension Cable (P/N HKN6246_), if additional length is needed.
- Install the antennas as per instructions provided with each antenna, refer to the APX Mobiles And Control Heads Installation Manual (P/N 6878215A01).
- Connect the Control Head CAN Cable between the Primary Radio and the O7 Control Head.
- Connect the short CAN Cable (P/N HKN6245_), between both radios.
- Connect the Palm Microphone (P/N HMN1090_), to the front of O7 Control Head.

5.2.1.2 Stack Mount Installation

[Figure 5-3](#) shows a complete setup of APX Mid-Power Dual-Radio Stack Mount Installation. Following are the installation procedures:

- Use the special *Dual Trunnion* (P/N HLN7045_), for installing two radios. Tighten the screws to verify the Trunnion sides are flush with the radios. Once flush, torque the screws to 50 in-lbs.

NOTE: Mark the Primary and Secondary Radios with the included P and S labels (P/N 54009321002). Marking the radios allows for proper setup.

- Connect the Accessory Connector (P/N HLN6863_), to the radios.

- Connect the DC Power Cables (P/N HKN4192_), to each radio. Connect the other end of the cables to the battery terminals (RED POSITIVE).
- Install the O7 Control Head, refer to the APX Mobiles And Control Heads Installation Manual (P/N 6878215A01).
- Install two speakers (P/N HSN4031_).
- Connect the Primary speaker to the on-line connector on the control head power cable. Connect the Secondary speaker to the accessory connector on the Secondary radio transceiver. Use the Speaker Extension Cable (P/N HKN6246_), if additional length is needed.
- Install the antennas as per instructions provided with each antenna, refer to the APX Mobiles And Control Heads Installation Manual (P/N 6878215A01).
- Connect the Control Head CAN Cable between the Primary Radio and the O7 Control Head.
- Connect the Dual Stack Radio CAN Cable (P/N HKN6249_), between both radios.
- Connect the Palm Microphone (P/N HMN1090_), to the front of O7 Control Head.

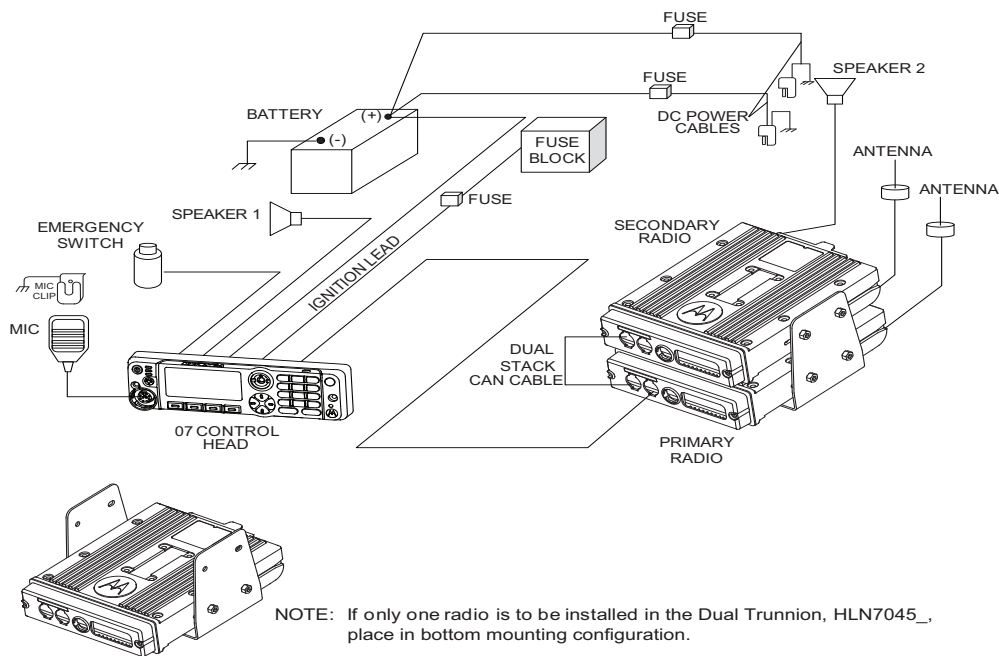

Figure 5-3. Stack Mount Installation For APX Mobile Mid-Power Dual-Radio O7 Control Head System

5.2.1.3 Dual-Radio Combined Audio Configuration

Speaker audio from each radio is routed into an audio combiner box located inside the enclosure. The combined audio is routed via the Dual-Radio Accessory Cable (HKN6250_) to a single speaker, mounted on the handlebars, and to an accessory plug for headset audio. Separate audio signals are not available in the Dual-Radio Combined Audio Configuration.

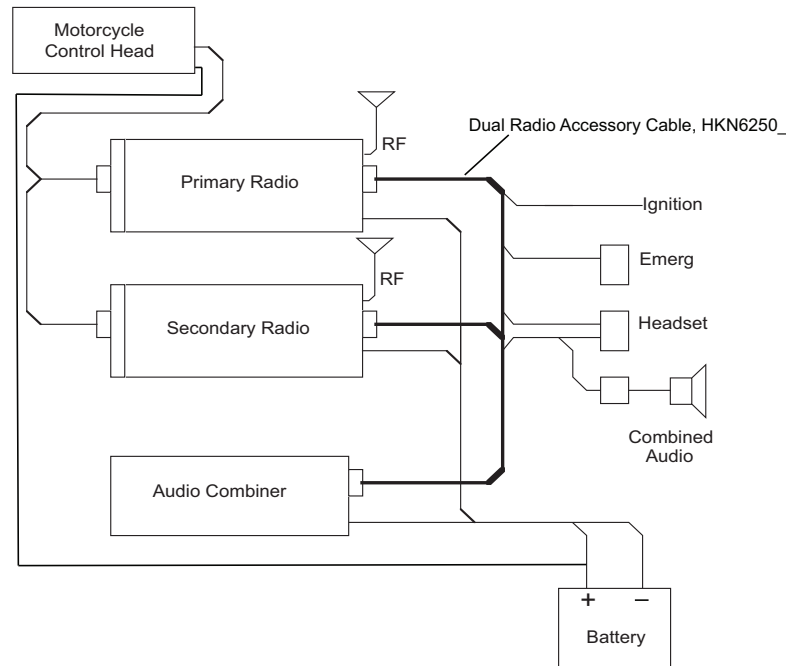

Figure 5-4. APX Mobile Mid-Power Dual-Radio, Dual-Radio Combined Audio Configuration

5.2.2 Cables

This section describes the APX Dual-Radio System cables installation.

5.2.2.1 APX Dual-Radio Cables

The APX Dual-Radio Cable (P/N HKN6250_) connects the Primary and Secondary radios to the O7 Control Head via the quick-disconnect connector. Attach the yellow radio connector end of the APX Dual-Radio Cable, to the front left of the Primary Radio (female connector, labeled “Control Unit”). Securely tighten the two screws. Attach the red radio connector end of the cable to the front left of the Secondary Radio (female connector, labeled “Control Unit”). Securely tighten these two screws as well. The quick-disconnect end of the APX Dual-Radio Cable will attach to the O7 Control Head, and is mounted in the operator’s compartment. This end of the cable also contains the connections for the speakers, the emergency foot switch, and the ignition sense.

5.2.2.2 Power and Ground Cables

Route the red Radio Power Cables from both radios to the vehicle’s battery compartment, using accepted industry methods and standards. It is important that both power leads are connected to the battery, rather than using one power lead through the vehicle and splitting it to both radios. This is because it is possible to have both mobile radios transmit at the same time (OTAR and data), and the power cable for each radio is rated to handle the maximum transmit current of that radio only. Both radios must connect to the same battery, to prevent cranking problem.

Be sure to grommet the firewall hole to protect the cable. Remove the 15-amp (P/N 6580283E06) or 20-amp (P/N 6580283E07) fuse from the fuseholder and connect the red lead of the Radio Power Cable to the positive battery terminal using the hardware provided as shown in [Figure 5-5](#). Connect the black lead to a convenient solid chassis ground point. DO NOT connect the black lead directly to the battery’s negative terminal.

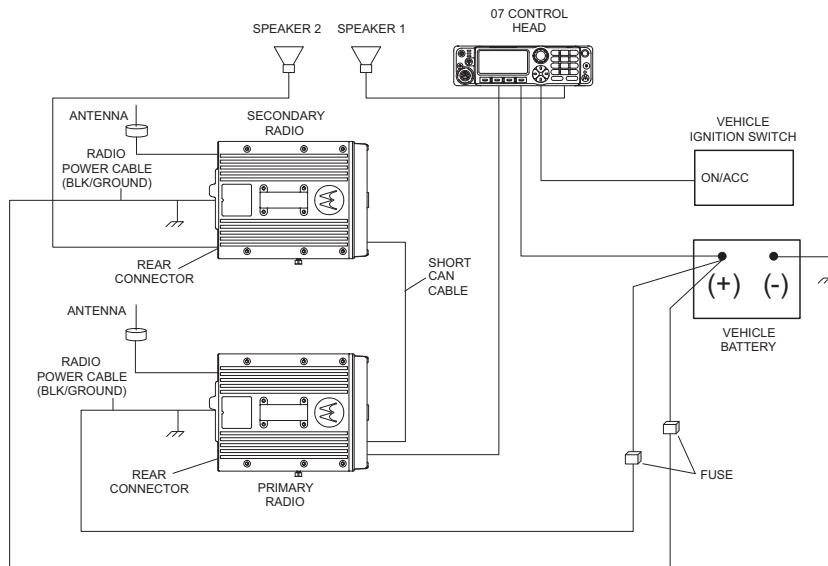

Figure 5-5. APX Mobile Dual-Radio System Cabling Interconnect Diagram For O7 Remote Mount

The black cables must have a good ground connection if the radios are to operate properly, and to prevent damage to the radios and cable kits. They should be grounded to the vehicle frame in the same location. On some late-model automobiles, the ground connection between the vehicles chassis and engine block is inadequate for good mobile radio operation. DO NOT remedy this by connecting the radio units ground cables directly to the battery. Connect a flexible metal ground strap between the engine block and a vehicle chassis point common to the radio set ground. Be sure the strap is heavy enough to carry maximum transmitter supply current.

All cables should be pushed out of the way as much as possible to prevent damage.

5.2.2.3 Ignition Cable

The APX Dual-Radio Cable (HKN6250_) has an ignition sense cable that must be used with every mobile installation. The ignition sense cable allows the radio to be turned on and off with the vehicle ignition switch, and allows the radio to remember the state of the radio on/off switch, even if it is changed while the vehicle is off.

- For radio ON/OFF control independent of the ignition switch, connect the orange ignition cable to “battery hot” at the vehicle fuse block.
- For radio ON/OFF control via the ignition switch, connect the orange ignition cable to “ignition” at the fuse block.

The ignition sense cable uses either a 3-Amp (P/N 6580283E01) or 4-Amp (P/N 6580283E02) fuse. For other considerations when connecting the ignition cable, see the APX Mobile Radios and Control Head Basic Service Manual (P/N 6875964M01).

5.2.2.4 Dual-Radio Accessory Cable

Refer to [Figure 5-6](#), for the Dual-Radio Accessory Cable (P/N HKN6250_), diagram.

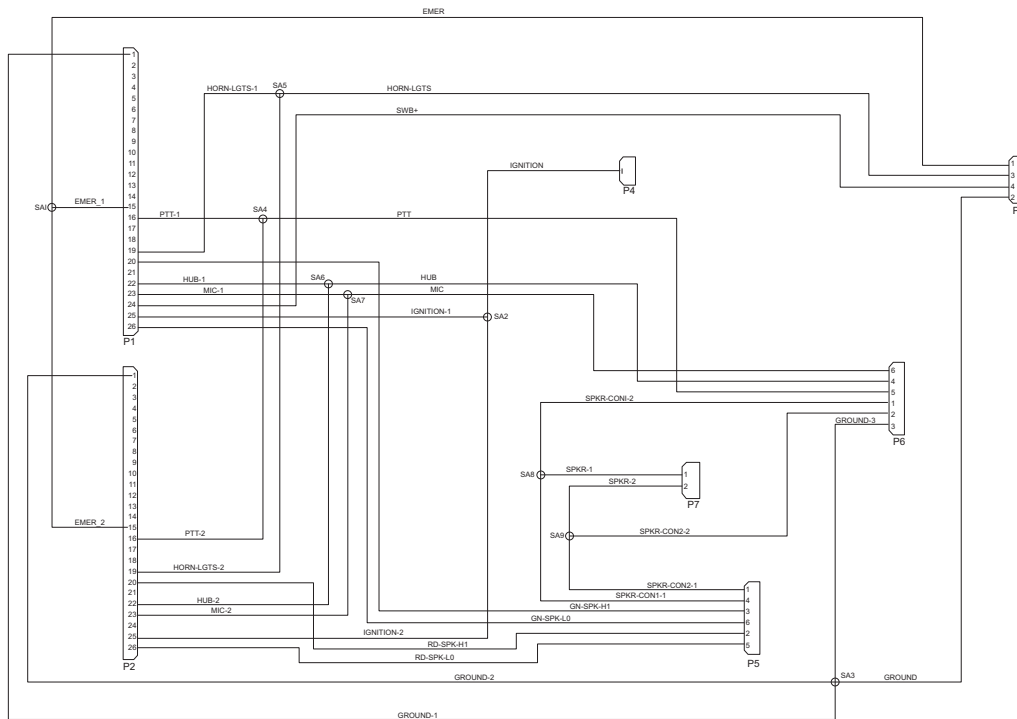

Figure 5-6. Dual-Radio Accessory Cable Diagram

5.3 Installation Considerations

Be aware of the following installation considerations:

1. Turn the vehicle's ignition switch off during installation.
2. Connect both black leads to the same vehicle chassis point. This prevents possible ground loop damage to the system should the ground point become bad.
3. Locate all fuses near the battery or the ignition.

5.4 Power Connections

Do the following:

1. Route the orange fused lead to the ignition voltage or battery voltage (see [Section 5.2.2.3](#), "Ignition Cable").
2. Route the red fused lead from each radio directly to battery positive.
3. Connect the black lead from each radio to the vehicle chassis.

5.5 APX Dual-Radio O7 Control Head Cable

Refer to [Figure 5-5](#), the APX Dual-Radio Cable (P/N HKN6250_) cable connects the O7 Control Head kit (P/N PMN1035_), to the dual remote radios via the quick-disconnect.

NOTE: Follow standard installation practices when routing and connecting all system cables. Use labels to identify both ends of each cable and make sure that all connections are electrically sound. Be sure that cables are secure and not routed or lying where they can be snagged, cut, or crushed.

5.6 Operator Compartment Units

This section describes operator compartment unit installations.

5.6.1 Quick-Disconnect Connector

NOTE: The O7 Control Head quick-disconnect connector typically mounts under the driver's seat. This allows the operator to disconnect it quickly and easily if so desired. Be sure adequate clearance exists between the connector and the seat for all positions of seat adjustment.

Mount the O7 Control Head connector bracket using the #10-16 x 3/4" self tapping screws supplied in the Hardware kit (P/N HLN4831_). Be sure it is easily accessible. Allow for the forward and backward movement of the seat. Use the #4-40 screws, nuts and lock washers to hold the O7 Control Head connector to the bracket.

5.6.2 Speaker Mounting

Connect both speakers to the gray, two-pin connectors at the quick-disconnect end of the APX Dual-Radio Cable (P/N HKN6250_) cable. Note the speaker wires are black/red and black/violet for the Primary radio and are green and orange for the Secondary Radio. Be sure the plugs are fully seated, and then tie up any surplus cable.

Two speakers are required to play the audio from each radio separately. There are two ways to connect speaker to radio:

- a. Speakers connect to radio directly.
- b. One speaker connects to Secondary radio, and the other speaker connects to O7 Control Head. The speaker connected to O7 Control Head, shall only play the audio from Primary Radio.

Refer to Section 2.5, Speaker, of the APX Mobiles And Control Heads Installation Manual (P/N 6878215A01), for further details on speaker mounting.

5.6.3 Microphone Hang-Up Clip

Refer to Section 2.6, Microphone Hang-Up Clip, of the APX Mobiles And Control Heads Installation Manual (P/N 6878215A01), for further details on Microphone Hang-Up Clip.

5.6.4 Emergency Footswitch

Emergency Footswitch must be connected to the control head, or wired to both radios. Refer to Chapter 4, Options and Accessories Installation, of the APX Mobiles And Control Heads Installation Manual (P/N 6878215A01). When installing the footswitch, discard the green and black extension wires packaged in the footswitch kit and use instead the wiring packaged with the APX Dual-Radio Cable (P/N HKN6250_).

5.7 Antenna Mounting

The three most important factors in antenna placement are maximizing the distance between the four antennas, maximizing the distance between the radios and the antennas (particularly between the VHF antenna and the radios), and using good ground planes for the antennas.

Mount the VHF antenna on the middle of the roof of the vehicle and the UHF antenna on the middle of the trunk. The further away from the edge and towards the middle of the roof or trunk that you can go, the better the ground plane for the respective antenna. This mounting configuration separates each antenna and puts the VHF antenna far away from the radios. The next best placement for the antennas is to locate them both on top of the roof. Mount the UHF antenna near the rear of the vehicle, about 6 inches from the edge of the roof.

As stated above, the antennas have a better ground plane the farther away from the edge of the roof. The antennas must also be a reasonable distance from each other to minimize the interference between them.



Caution

Avoid using lip-mounted antennas. A lip-mount does not supply an adequate ground plane for the antennas.

Appendix A Other Configurations

A.1 Converting to a Single-Radio System

1. Disconnect the CAN cable between both the radios. This is to avoid one Standalone Radio and one Primary Radio in the system, and cause FL01-90 to be displayed.
2. Read the codeplug of the radio that needs to be programmed.
3. Using CPS, change the “Radio Selection” field to “Standalone Radio”.
4. Write the codeplug into the APX Mobile radio.
5. Connect a standard O7 Control Head and cable to the newly configured APX Mobile Single-Radio System.

A.2 Changing the Control-Head Type

- The APX Dual-Radio System is only compatible with the O7 Control Head, and all other control head types are not supported.

A.3 Converting Radios Equipped With Dual-Radio Software into an APX Dual-Radio System

1. Ensure both the radios are disconnected.
2. Read the codeplug of one radio.
3. Using CPS, follow the setup instructions in [Chapter 3, "Codeplug Configuration"](#) to configure it as the Primary Radio.
4. Write the codeplug into this APX Mobile Radio.
5. The codeplug configuration is done for the second APX Mobile radio, to configure it as the Secondary Radio.
6. Using CAN cable connect both radios, and the O7 Control Head.

A.4 Converting Radios Not Equipped With Dual-Radio Software into an APX Dual-Radio System

- Customers who have fielded APX7500, APX6500, or APX6500Li radios are able to purchase the Dual-Radio Software as a flashport[®] upgrade (flashport option P/N GA01058_B).
- This will allow them to configure their current mobiles, to be used as either Primary or Secondary Radios in an APX Dual-Radio configuration.
- The required hardware, including the Dual-Radio Cable and Speaker Extension Cable must be purchased separately as aftermarket kits. The optional Stack Mount Trunnion and Audio Combiner can also be purchased separately from Motorola’s Accessories and Aftermarket Division (AAD), if needed.
- APX mobiles using control heads different from the O7 Control Head must be retrofitted with a remote mounted O7, in order to support the APX Dual-Radio operation.

Notes



Motorola Solutions, Inc.
1303 East Algonquin Road
Schaumburg, Illinois 60196 U.S.A.

MOTOROLA, MOTO, MOTOROLA SOLUTIONS and the Stylized M logo are trademarks or registered trademarks of Motorola Trademark Holdings, LLC and are used under license. All other trademarks are the property of their respective owners. © 2014 Motorola Solutions, Inc. All rights reserved. August 2014.

www.motorolasolutions.com/APX



MN000770A01-AA