



Tactical Software-Defined Radio, Redefined.

The Barrett PRC-4090 HF SDR Transceiver is the centerpiece of the Barrett range of tactical HF communications equipment. It combines Software-Defined Radio technology with the intuitive "ease of use" that has become synonymous with the Barrett name. When teamed with other Barrett HF products, the versatile Barrett PRC-4090 transceiver provides secure email, data transfer and telephone connectivity within a HF network and outwards to international telephone and internet networks.

The Barrett PRC-4090 transceiver can be controlled from all major mobile and desktop platforms including iOS, Android and Windows devices for wireless voice and radio control via the 4000 series HF remote control app.

- **Advanced, software-defined radio architecture**
- **Intuitive and user-friendly touch-screen control**
- **IP connectivity (WiFi/Internet)**
- **Remote operation via iOS, Android & Windows devices**
- **USB transceiver programming and key fill**
- **Multi-Language software interface**
- **Digital Voice and Secure Digital Voice options**
- **2G & 3G Automatic Link Establishment (ALE) options**
- **On-board high speed data options**
- **Up to 150W transmit power**
- **Low current consumption**
- **GPS Push option and integrated GPS**
- **OTAR & OTAZ**
- **Planned intercom**



Barrett PRC-4090 HF SDR manpack with multicam daypack and optional H250 handset. Remote cable up to 50m.

Lightweight and Compact Design

Using the latest lightweight alloys, the PRC-4090 weighs 2.95kg. Its small physical size, one of the smallest on the market, makes it comfortable to wear and operate when deployed as a tactical manpack. The manpack is 5.0kg with Barrett advanced 16 Ah, quick change Li-ion battery.



Widely available BB2590 Li-ion batteries can be utilised giving a gross weight of 4.3kg, or 3.95kg when used with a BA5590 non-rechargeable battery pack.



Extended operation time

The Barrett 16Ah advanced Li-ion battery provides the PRC-4090 transceiver up to 64 hours Rx (only) operation, and up to 21 hours Rx/Tx is possible in a 90/10 duty cycle. The battery includes inbuilt charge management allowing for charging in operation or separately from any available 24V d.c. source, including solar panels and hand crank generators.

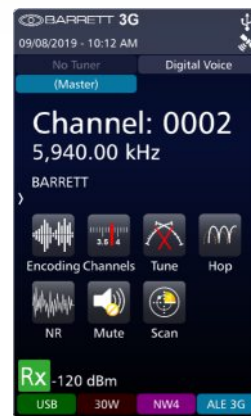

Display

The display is a super bright, high definition 24-bit colour touchscreen which provides optimal viewing ability in all lighting conditions. It provides access to the most advanced and intuitive HF radio interface on the market.

The PRC-4090 software has four separate theme modes for use in different ambient light conditions. The screen can also be turned into landscape format via the user interface, if required.

Control Handset

The fully featured tactical control handset is remotely connected to the transceiver unit. This enables the operator to wear the display unit on their person and have full operational control of the manpack without needlessly dismounting the manpack transceiver unit itself. It can also be used in conjunction with H250 handsets.

The PRC-4090 manpack ships with a handset cradle including Molle attachment for use on webbing or any Molle compatible equipment. The handset can be docked in the cradle in reverse for tactical operation.

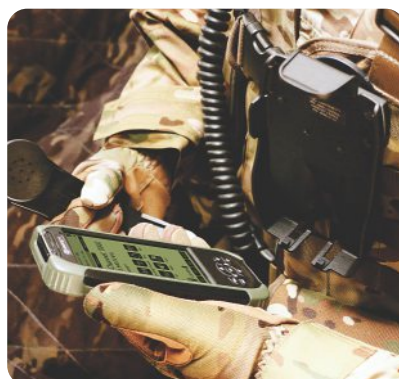
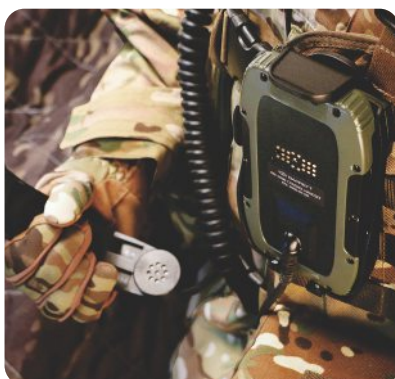

Digital Voice and Secure Digital Voice (optional)

Digital Voice (DV) can improve the reliability of communications over noisy channels where reception of analogue voice can be very poor. Voice can be improved markedly to the point where barely usable frequencies can be made clear. Secure Digital Voice (SDV) allows users to encrypt their communications over HF radio providing a secure HF network. Barrett offer two SDV encryption standards. A non-export controlled DES 56 vocoder with rates of 700, 1200 and 2400bps or an export controlled AES 256 vocoder with rates of 600, 1200 and 2400bps. Both deliver cutting edge voice communication performance and security at all times.

Advanced Frequency Hopping (optional)

Available hopping rates of 5 or 25 hops per second, the use of an 8 digit hopping encryption key, with a user selectable hopping bandwidth to suit a variety of antenna types means that the system provides excellent protection against electronic warfare (EW) attacks and can be operated for extended periods in the field without synchronisation.

IP Network Connectivity

Built into the PRC-4090 System Docking Station, the Ethernet accesspoint allows the HF network to connect directly to PCs. This allows the HF network to integrate with Barrett's tracking and data options.

Integrated GPS

Barrett's integrated GPS is built into the handset. The integrated GPS enhances emergency call features and position information on all deployed equivalently equipped HF assets. Combined with Barrett's GPS Push tracking solution, Barrett can provide unrivaled asset tracking performance over HF radio.

Advanced Calling Features

The Barrett PRC-4090 transceiver provides four and six digit selective call features, including telephone interconnect, SMS text, GPS tracking, status calling, point to point and/or multipoint secure call and remote transceiver disable capabilities.

Data Modem Compatibility

Multiple data waveform options are provided in the Barrett PRC-4090 including MIL-STD-188-110A/B (STANAG 4285, 4415, 4481, 4529, 4539), 3G Packet Data (STANAG 4538), CLOVER 2500 and CLOVER 3000. Combined with Barrett's latest data transmission software and intuitive user interface, these waveforms provide unparalleled performance with "throughput" rates up to and in excess of 19,200 bps.

2G & 3G ALE (optional)

Backwards compatible 2nd generation (2G) Automatic Link Establishment (ALE), based on MIL-STD-188-141B (JITC certified) and FED-STD-1045, is available as an option for automatic point-to-point and/or multipoint calling, including telephone interconnect, AMD text messaging and GPS position. For superior fast link setup (FLSU), robust packet data and greater penetration on noisy channels, 3rd generation (3G) ALE based on STANAG 4538 is also available.

Enhanced DSP Noise Reduction

The digital signal processor (DSP) provides clear intelligible voice communications on analogue circuits through the digital removal of background noise and interference.

Automatic antenna tuner

Whips and un-tuned wire antennas are accommodated with the inbuilt, fully automatic antenna tuner. Various lightweight broadband and tunable tactical antennas are available.



PRC-4090 HF Tactical Manpack Package - P/N 4090-01-10

PRC-4090 HF Tactical Transceiver
P/N 4090-00-01



Control Handset
P/N 4090-01-00



PRC-4090 Li-ion Battery 16Ah
P/N 4090-03-05

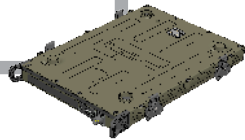

Control Handset Cradle
P/N 4090-01-01



*Main components only shown. Some items not shown for clarity.

The Barrett PRC-4090 HF Tactical Manpack Package is ideal for extended portable field operations providing the tactical user with effective, secure and comprehensive communications with remotely sited command locations. The HF Tactical Manpack Package includes all necessary antennas, smart battery and backpack carrying system.

PRC-4091 HF Tactical Mobile Package - P/N 4090-05-10

PRC-4090 HF Tactical Transceiver
P/N 4090-00-01



Control Handset
P/N 4090-01-00

System Docking Station
P/N 4090-05-00



Handset Docking Station
P/N 4090-01-08



Anti-Vibration Mounting Plate
P/N 4090-05-02

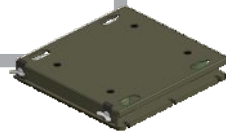

External Speaker
P/N 4090-01-04



*Main components only shown. Some items not shown for clarity.

The Barrett PRC-4091 HF Tactical Mobile Package provides a convenient rapid docking system and transmitter power amplification to 125 W PEP. With options for either 12 V d.c. or 24 V d.c. power supply and the flexibility of dismantled use of the PRC-4090 transceiver when not in the vehicle (additional accessories may be required), the PRC-4091 HF Tactical Mobile Package can be installed in a wide range of vehicle types with antenna options to suit.

PRC-4092 HF Tactical Base Package - P/N 4090-06-10

PRC-4090 HF Tactical Transceiver
P/N 4090-00-01



Control Handset
P/N 4090-01-00

System Docking Station
P/N 4090-05-00



Handset Docking Station
P/N 4090-01-08



PRC-4022 AC Power Supply
P/N 4090-03-01



External Speaker
P/N 4090-01-04



*Main components only shown. Some items not shown for clarity.

The Barrett PRC-4092 HF Tactical Base Package, like the PRC-4091 mobile package includes the system docking station. The PRC-4022 AC Power Supply provides 24V d.c. which increases the RF output of the PRC-4090 transceiver to 150 W PEP. The HF tactical base package can be installed in a number of temporary base and fixed command configurations powered by a variety of a.c. and d.c. power sources. A range of antenna options are available to suit different installation configurations.

PRC-4090 HF SDR Transceiver - General Specifications

Tx Frequency Range	1.6MHz – 30MHz
Rx Frequency Range	250KHz – 30MHz
Channel Capacity	1000
Frequency Stability	±0.1 ppm (±0.5 ppm un-synchronised)
Frequency Resolution	1 Hz tunable receiver
Operating Modes	J3E (USB, LSB) - H2B (AM) - J2A (CW) - CF (Custom Filter) - ISB (Data) Option
Filter Bandwidths	Fully software-defined standard and custom filter range from 300Hz to 3300Hz (6KHz ISB Option)
Operating Temperature	-30°C to +70°C, relative humidity 95%, non condensing
Frequency Hopping (optional)	5 or 25 hops per second
Digital Voice (optional)	Auto baud rates 600/700, 1200, 2400 (MELP/TWELP)
Encryption standards (optional)	AES 256 & DES 56
Supply Voltage	+12V d.c. to +28V d.c. operation
Selcall System	Based on CCIR 493-4, 4 and 6 digit systems
ALE Standards (optional)	2G & 3G ALE (MIL STD 188-141B & STANAG 4538)
Current Consumption	250mA (Rx)
Sensitivity	-121 dBm (0.20 µV) for 10dB SINAD*
RF Output Power	10W / 30W PEP (with 16.4V d.c. battery supply) & 150W PEP (with SDS & 24V Supply)
Duty Cycle	100% data with fan option
Weight	<ul style="list-style-type: none"> - PRC-4090 transceiver body (only) 2.95kg - PRC-4090 transceiver body with advanced 16Ah Li-ion battery pack (4090-03-05) 5.00kg - PRC-4090 transceiver body with BB2590 Li-ion battery pack 4.30kg - PRC-4090 transceiver body with BA5590 (non rechargeable) battery pack 3.95kg
Battery Standards	Barrett High performance 16Ah Li-ion battery pack with inbuilt charger (2.05kg) Designed to meet or exceed: <ul style="list-style-type: none"> - FCC – Part 87# - FCC – Part 90# - IC (Industry Canada)# - CE# - Australia/New Zealand AS/NZS 4770:2000 and AS/NZS 4582:1999 and AS60529:2004# - EMC and vibration Standard IEC 945# - Designed to meet MIL-STD 810G for immersion, temperature, humidity, altitude, shock, vibration - NTIA# - JITC#

*(reduced sensitivity 250 kHz to 500 kHz) # Approval pending - Specifications are typical. Equipment descriptions and specifications are subject to change without notice or obligation.

Control Handset

P/N 4090-01-00



Front

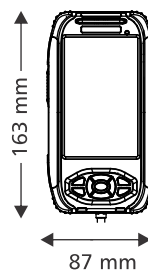

Side

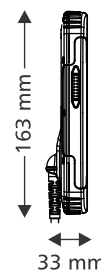

Handset docking station

P/N 4090-01-08



Front

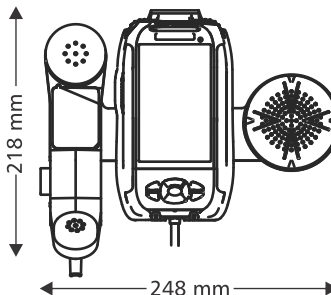

Side

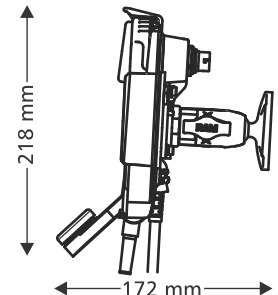

PRC-4090 HF SDR Transceiver
P/N 4090-00-01



Front

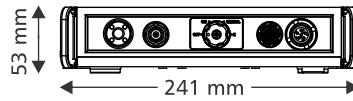

Side

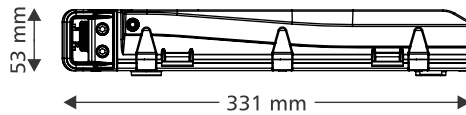

Top

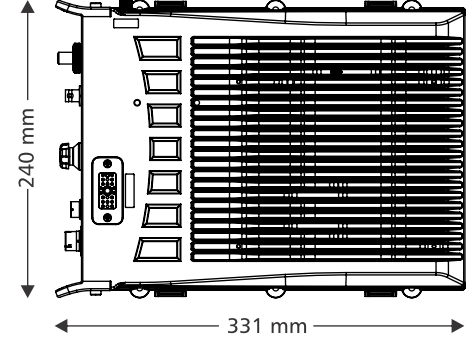

PRC-4090 Li-ion Battery 16Ah
P/N 4090-03-05

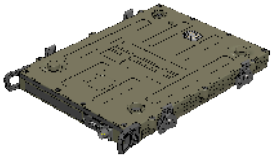

Front

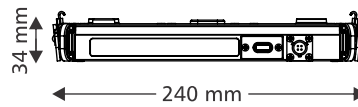

Side

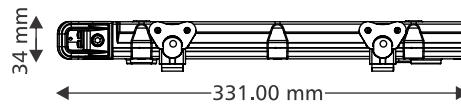

Top

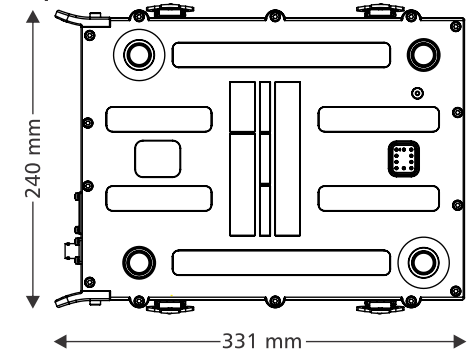

PRC-4090 System Docking Station
P/N 4090-05-00



Rear

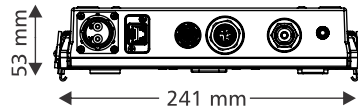

Side

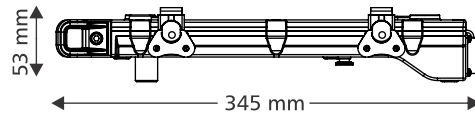

Top

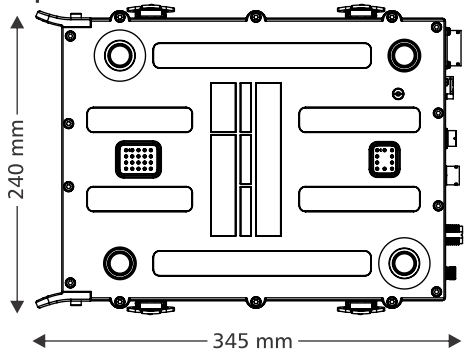

PRC-4022 AC Power Supply
P/N 4090-03-01



Front

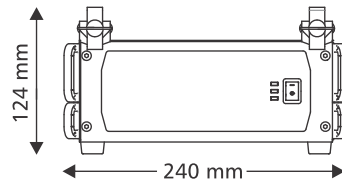

Side

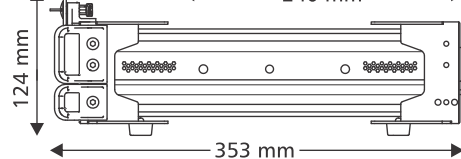

Top

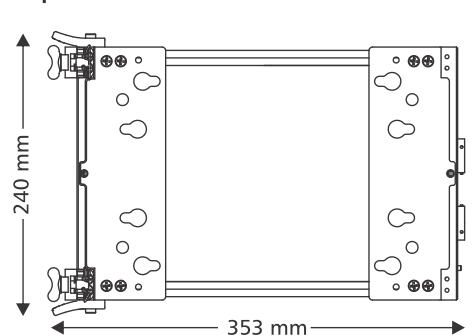

Head Office:

Barrett Communications Pty Ltd
47 Discovery Drive, Bibra Lake,
WA, 6163 AUSTRALIA
Tel: +61 8 9434 1700
Fax: +61 8 9418 6757
Email: info@barrettcommunications.com.au

BCB40900/3

ISO 9001
BUREAU VERITAS
Certification

