

APX™ TWO-WAY RADIOS

# APX 1000 MODEL 2 USER GUIDE





## RF Energy Exposure and Product Safety Guide for Portable Two-Way Radios

ATTENTION!

This radio is restricted to Occupational use only. Before using the radio, read the RF Energy Exposure and Product Safety Guide for Portable Two-Way Radios which contains important operating instructions for safe usage and RF energy awareness and control for Compliance with applicable standards and Regulations.

### Radio Controls

#### Single Knob Radio

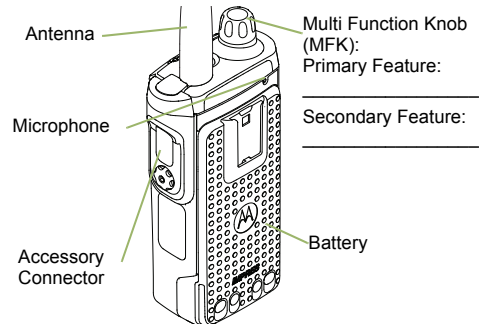
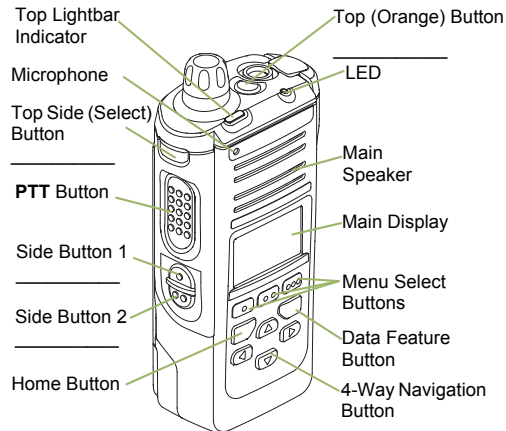

#### Two Knobs Radio

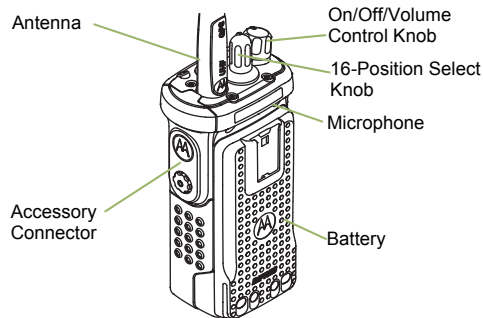
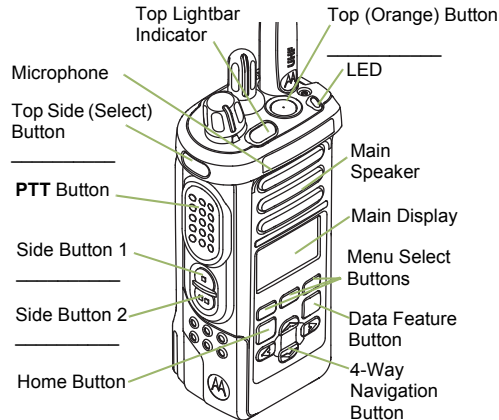

#### Radio On/Off

- **On** – Press and hold the **MFK** until the display lights up.
- **Off** – Press and hold the **MFK** until you see **Power off?**, then press **Menu Select** button below **Yes**.

#### Radio On/Off

- **On** – Rotate the **On/Off/Volume Control Knob** clockwise until you hear a click.
- **Off** – Rotate the **On/Off/Volume Control Knob** counterclockwise until you hear a click.

#### Select Zone and Channel

- 1 Press the **MFK** to see  on the screen.
- 2 Turn the **MFK** to scroll to desired zone or channel.
- 3 Press **MFK** to select the desired zone or channel and exit Mode Change.

#### Select Zone and Channel

- 1 Rotate the preprogrammed **16-Position Select Knob** to the desired channel.

#### Receiving and Transmitting

- 1 Select zone/channel.

MOTOROLA, MOTO, MOTOROLA SOLUTIONS and the Stylized M logo are trademarks or registered trademarks of Motorola Trademark Holdings, LLC and are used under license. All other trademarks are the property of their respective owners.

© 2014 and 2015 by Motorola Solutions, Inc. All Rights Reserved.  
1303 East Algonquin Road, Schaumburg, Illinois 60196,  
U.S.A.  
06/15



PMLN6812B



- Listen for a transmission.  
**OR**  
Press and hold **Volume Set** button.  
**OR**  
Press **Monitor** button and listen for activity.
- Adjust volume, if necessary.
- Press the **PTT** button to transmit; release to receive.

### Sending an Emergency Alarm

- Press and hold the **Emergency** button\*.
- The display shows **Emergency** and the current zone/channel. Radio sounds a short, medium-pitched tone, and the LED blinks red momentarily.
- When acknowledgment is received, you hear four beeps; alarm ends; and radio exits emergency.
- Press and hold the **Emergency** button to exit emergency.

\* **Default timer of Emergency button press to activate Emergency is 50 milliseconds.** This timer is programmable, see **Emergency Operation** in the user guide for details.

To exit emergency at any time, press and hold the **Emergency** button.

### Sending an Emergency Call

- Press the **Emergency** button.
- Press and hold the **PTT** button. Speak clearly into the microphone.
- Release the **PTT** button to end call.
- Press and hold **Emergency** button to exit emergency.

### Sending a Silent Emergency Call

- Press the **Emergency** button.

- The display does not change; the LED does not light up, and there is no tone.
- Silent emergency continues until you:  
Press and hold the **Emergency** button to exit emergency state.  
**OR**  
Press and release the **PTT** button to exit the Silent Emergency Alarm mode and enter regular dispatch or Emergency Call mode.

### Display Status Icons

	<b>MFK</b> is in Mode Change feature.
	<b>MFK</b> is in Volume Change feature.
	Receiving a call or data.
	Transmitting a call or data.
	Blinks when the battery is low.
	The more stripes, the stronger the signal strength for the current site (trunking only).
	Direct radio to radio communication or connected through a repeater. <b>On</b> = Direct <b>Off</b> = Repeater
	This channel is being monitored.
<b>H</b> OR <b>L</b>	<b>L</b> = Radio is set at Low power. <b>H</b> = Radio is set at High power.

	Scanning a scan list.
	<b>Blinking dot</b> = Detects activity on the Priority-One Channel during scan. <b>Steady dot</b> = Detects activity on the Priority-Two Channel during scan.
	The vote scan feature is enabled.
	<b>On</b> = User is currently associated with the radio. <b>Off</b> = User is currently not associated with the radio. <b>Blinking</b> = Device registration or user registration with the server failed due to an invalid username or pin.
	Data activity is present.
	<b>On</b> = Secure operation. <b>Off</b> = Clear operation. <b>Blinking</b> = Receiving an encrypted voice call.

### Menu Navigation

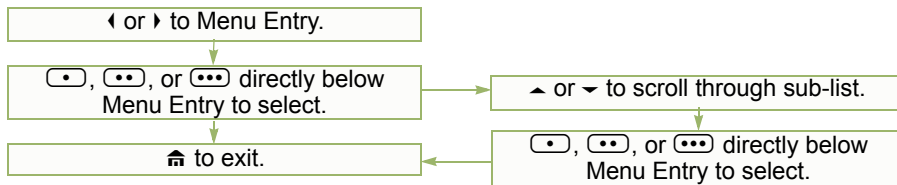

# Contents

**Declaration of Conformity..... 7**

**Important Safety Information..... 9**

**Software Version..... 10**

Notice to Users (FCC and Industry  
Canada)..... 10

**Consignes de sécurité  
importantes..... 11**

**Version logicielle..... 12**

Avis aux utilisateurs (FCC et Industrie  
Canada)..... 12

**Computer Software Copyrights.... 13**

**Documentation Copyrights..... 14**

**Disclaimer..... 15**

**Getting Started..... 16**

How to Use This Guide..... 16

Notations Used in This Manual..... 16

Additional Performance Enhancement..... 17

Dynamic System Resilience (DSR).... 17

CrossTalk Prevention..... 17

SecureNet..... 17

Conventional Talkgroup and Radio

Scan Enhancements..... 17

What Your Dealer/System Administrator

Can Tell You..... 18

**Preparing Your Radio for Use..... 19**

Charging the Battery..... 19

Attaching the Battery..... 19

Attaching the Antenna..... 21

Removing and Attaching the Accessory	
Connector Cover.....	23
Attaching the Belt Clip.....	24
Turning On the Radio.....	26
Adjusting the Volume.....	28

## Identifying Radio Controls..... 30

Radio Parts and Controls.....	30
Programmable Features.....	33
Assignable Radio Functions.....	33
Assignable Settings or Utility	
Functions.....	36
Accessing the Preprogrammed Functions.....	36
Menu Select Buttons.....	38
Home Button.....	38
4-Way Navigation Button.....	38
Data Feature Button.....	38
 Multi-Function Knob (MFK).....	38
Push-To-Talk (PTT) Button.....	39

## Identifying Status Indicators.....41

Status Icons.....	41
Text Messaging Service (TMS) Indicators.....	43

TMS Status Icons.....	43
TMS Menu Options.....	44
Call Type Icons.....	44
LED Indicator.....	45
Top Lightbar Indicator.....	47
Intelligent Lighting Indicators.....	48
Alert Tones.....	49
Phone Call Displays and Alerts.....	52

## General Radio Operation.....54

Selecting a Zone.....	54
Selecting a Radio Channel.....	54
Mode Select Feature.....	55
Saving a Zone and a Channel to a	
Softkey.....	56
Saving a Zone and a Channel to a	
Button.....	56
Receiving and Responding to a Radio Call... 57	
Receiving and Responding to a	
Talkgroup Call.....	57
Receiving and Responding to a	
Private Call (Trunking Only).....	57
Receiving and Responding to a	
Telephone Call (Trunking Only)....	58
Methods to Make a Radio Call.....	59

Making a Talkgroup Call.....	59	Making a Private Call from Contacts...	70
Making a Private Call (Trunking Only).....	60	Adding a Contact to a Call List.....	70
Making an Enhanced Private Call (Trunking Only).....	60	Removing a Contact from a Call List.....	71
Making a Telephone Call (Trunking Only).....	61	Viewing Details of a Contact.....	71
Switching Between Repeater or Direct Operation Button.....	62	Scan Lists.....	72
Monitor Feature.....	62	Viewing a Scan List.....	72
Monitoring a Channel.....	62	Editing the Scan List.....	72
Monitoring Conventional Mode.....	63	Changing the Scan List Status.....	73
<b>Advanced Features.....</b>	<b>64</b>	Viewing and Changing the Priority Status.....	74
Advanced Call Features.....	64	Scan.....	74
Selective Call (ASTRO Conventional Only).....	64	Turning Scan On or Off.....	74
Talkgroup Call Feature (Conventional Operation Only).....	65	Making a Dynamic Priority Change (Conventional Scan Only).....	75
Sending a Status Call.....	65	Deleting a Nuisance Channel.....	75
Responding to the Dynamic Regrouping Feature (Trunking Only).....	66	Restoring a Nuisance Channel.....	75
Dynamic Zone Programming (DZP)....	67	Call Alert Paging.....	76
Contacts.....	69	Receiving a Call Alert Page.....	76
		Sending a Call Alert Page.....	76
		Quick Call II (ASTRO P25 Digital Trunking and Conventional).....	77
		Initiating a Quick Call II Transmission.....	78
		Emergency Operation.....	78
		Sending an Emergency Alarm.....	79

Sending an Emergency Call (Trunking Only).....	80	Viewing a Saved Waypoint.....	96
Sending an Emergency Alarm with Emergency Call.....	80	Deleting a Single Saved Waypoint.....	97
Sending a Silent Emergency Alarm....	81	Deleting All Saved Waypoints.....	97
Change of Channels during Emergency.....	81	Measuring the Distance and Bearing from a Saved Waypoint....	98
Emergency Keep-Alive Feature.....	82	Location Feature in Emergency Mode.....	98
Automatic Registration Service (ARS).....	82	Peer-Location on the Display (ASTRO Conventional only).....	99
Selecting or Changing the ARS Mode.....	82	Geofence (ASTRO 25 Trunking System)....	100
User Login Feature.....	83	Entering the Geofence Area.....	100
Text Messaging Service (TMS).....	85	Trunking System Controls.....	101
Sending a Quick Text Message.....	85	Operating in Failsoft System.....	101
Priority Status and Request Reply of a New Text Message.....	87	Out-of-Range Radio.....	102
Global Positioning System / Global Navigation Satellite System.....	92	Site Trunking Feature.....	102
GPS Operation.....	93	Locking and Unlocking a Site.....	102
GPS Performance Enhancement.....	94	Site Display and Search Button.....	103
The Outdoor Location Feature (Using GPS).....	94	Over-the-Air Programming (POP 25, ASTRO 25, ASTRO Conventional).....	103
Military Grid Reference System (MGRS) Coordinates.....	95	Responding to the Notification of Upgrade.....	104
Accessing the Outdoor Location Feature.....	95	Voice Announcement.....	105
Saving a Waypoint.....	96	Utilities.....	106
		Viewing Recent Calls.....	106
		Selecting the Power Level.....	107
		Selecting a Radio Profile.....	107



Enabling and Disabling the Radio	Battery Care.....	123
Alias.....	Battery Charge Status.....	123
Selecting the Audio Speaker.....	Battery Recycling and Disposal.....	124
Controlling the Display Backlight.....		
Locking and Unlocking the Controls.....	<b>Accessories.....</b>	<b>125</b>
Turning the Controls and Buttons		
Tones On or Off.....		
Turning Voice Mute On or Off.....	<b>Maritime Radio Use in the VHF</b>	
Using the Time-Out Timer.....	<b>Frequency Range.....</b>	<b>126</b>
Time and Date Setup.....	Special Channel Assignments.....	126
Using Conventional Squelch	Emergency Channel.....	126
Operation Features.....	Non-Commercial Call Channel.....	126
Using the PL Defeat Feature.....	Operating Frequency Requirements.....	126
Digital PTT ID Support.....	Declaration of Compliance for the Use of	
Smart PTT Feature (Conventional	Distress and Safety Frequencies.....	129
Only).....	Technical Parameters for Interfacing	
Transmit Inhibit.....	External Data Sources.....	129
IMPRES Battery Annunciator.....		
General Radio Information.....	<b>Glossary.....</b>	<b>130</b>
<b>Helpful Tips.....</b>	<b>Limited Warranty.....</b>	<b>135</b>
Radio Care.....	MOTOROLA COMMUNICATION	
Cleaning Your Radio.....	PRODUCTS.....	135
Proper Ways to Handle the Radio....		
Radio Service and Repair.....		

I. WHAT THIS WARRANTY COVERS AND FOR HOW LONG:.....	135
II. GENERAL PROVISIONS:.....	136
III. STATE LAW RIGHTS:.....	137
IV. HOW TO GET WARRANTY SERVICE:..	137
V. WHAT THIS WARRANTY DOES NOT COVER:.....	137
VI. PATENT AND SOFTWARE PROVISIONS:.....	138
VII. GOVERNING LAW:.....	139
VIII. For Australia Only.....	139

## Declaration of Conformity

This declaration is applicable to your radio only if your radio is labeled with the FCC logo shown below.

### Declaration of Conformity

Per FCC CFR 47 Part 2 Section 2.1077(a)



Responsible Party

Name: Motorola Solutions, Inc.

Address: 1303 East Algonquin Road, Schaumburg, IL 60196-1078, U.S.A.

Phone Number: 1-800-927-2744

Hereby declares that the product:

Model Name: **APX 1000**

conforms to the following regulations:

FCC Part 15, subpart B, section 15.107(a), 15.107(d) and section 15.109(a)

## Class B Digital Device

As a personal computer peripheral, this device complies with Part 15 of the FCC Rules. Operation is subject to the following two conditions:

- 1 This device may not cause harmful interference, and
- 2 This device must accept any interference received, including interference that may cause undesired operation.



### Note

This equipment has been tested and found to comply with the limits for a Class B digital device, pursuant to part 15 of the FCC Rules. These limits are designed to provide reasonable protection against harmful interference in a residential installation. This equipment generates, uses and can radiate radio frequency energy and, if not installed and used in accordance with the instructions, may cause harmful interference to radio communications. However, there is no guarantee that interference will not occur in a particular installation.

If this equipment does cause harmful interference to radio or television reception, which can be determined by turning the equipment off and on, the user is encouraged to try to correct the interference by one or more of the following measures:

- Reorient or relocate the receiving antenna.
- Increase the separation between the equipment and receiver.
- Connect the equipment into an outlet on a circuit different from that to which the receiver is connected.
- Consult the dealer or an experienced radio or TV technician for help.

## Important Safety Information

### RF Energy Exposure and Product Safety Guide for Portable Two-Way Radios

#### ATTENTION!

#### **This radio is restricted to Occupational use only.**

Before using the radio, read the RF Energy Exposure and Product Safety Guide for Portable Two-Way Radios which contains important operating instructions for safe usage and RF energy awareness and control for Compliance with applicable standards and Regulations.

For a list of Motorola-approved antennas, batteries, and other accessories, visit the following website:

<http://www.motorolasolutions.com/APX>

*Under Industry Canada regulations, this radio transmitter may only operate using an antenna of a type and maximum (or lesser) gain approved for the transmitter by Industry Canada. To reduce potential radio interference to other users, the antenna type and its gain should be so chosen that the equivalent isotropically radiated power (e.i.r.p.) is not more than that necessary for successful communication.*

*This radio transmitter has been approved by Industry Canada to operate with Motorola-approved antenna with the maximum permissible gain and required antenna impedance for each antenna type indicated. Antenna types not included in this list, having a gain greater than the maximum gain indicated for that type, are strictly prohibited for use with this device.*

## Software Version

All the features described in the following sections are supported by the software version **R14.00.00** or later.

See [Accessing the Radio Information](#) on page 117 to determine the software version of your radio.

Check with your dealer or system administrator for more details of all the features supported.

### Notice to Users (FCC and Industry Canada)

This device complies with Part 15 of the FCC rules and RSS 210 of the Industry Canada rules per the following conditions:

- This device may not cause harmful interference.
- This device must accept any interference received, including interference that may cause undesired operation.
- Changes or modifications made to this device, not expressly approved by Motorola, could void the authority of the user to operate this equipment.

## Consignes de sécurité importantes

### Radios bidirectionnelles portatives : exposition aux radiofréquences et sécurité du produit

#### ATTENTION!

**Cette radio ne doit être utilisée qu'à des fins professionnelles.** Avant d'utiliser la radio, lisez le guide Radios bidirectionnelles portatives : exposition aux radiofréquences et sécurité du produit, qui contient d'importantes instructions de fonctionnement pour une utilisation sécuritaire et des informations sur l'exposition aux fréquences radioélectriques, dans le but d'assurer votre conformité aux normes et règlements en vigueur.

Visitez le site Web suivant pour obtenir la liste des antennes, des batteries et des autres accessoires approuvés par Motorola :

<http://www.motorolasolutions.com/APX>

*Selon la réglementation d'Industrie Canada, cet émetteur radio ne peut être utilisé qu'avec une antenne dont le type et le gain maximal (ou minimal) sont approuvés par Industrie Canada pour cet émetteur. Afin de limiter les interférences radio pour*

*les autres utilisateurs, le type et le gain de l'antenne doivent être choisis de façon à ce que la puissance isotrope rayonnée équivalente (P.I.R.E.) ne soit pas plus forte qu'il ne le faut pour établir la communication.*

*Cet émetteur radio a été approuvé par Industrie Canada pour utilisation avec une antenne approuvée par Motorola offrant le gain maximal autorisé et l'impédance requise pour le type d'antenne indiqué. Il est strictement interdit d'utiliser avec cet appareil tout type d'antenne ne figurant pas dans cette liste et présentant un gain supérieur au maximum indiqué pour le type.*

## Version logicielle

Toutes les fonctions décrites dans les sections suivantes sont prises en charge par la version **R14.00.00** ou les versions ultérieures du logiciel de la radio.

Pour obtenir davantage de renseignements à propos des fonctions prises en charge, adressez-vous à votre détaillant ou à votre administrateur de système.

### Avis aux utilisateurs (FCC et Industrie Canada)

---

Cet appareil est conforme à la Partie 15 des règlements de la FCC et RSS 210 du règlement d'Industrie Canada selon les conditions énumérées ci-dessous:

- Ce dispositif ne doit pas causer d'interférences nuisibles.
- Cet appareil doit accepter toute interférence reçue, y compris les interférences qui peuvent perturber le fonctionnement.
- Les changements ou les modifications apportées à ce dispositif, non expressément approuvées par

Motorola, peuvent annuler le droit de l'utilisateur à utiliser cet équipement.



## Computer Software Copyrights

The Motorola products described in this manual may include copyrighted Motorola computer programs stored in semiconductor memories or other media. Laws in the United States and other countries preserve for Motorola certain exclusive rights for copyrighted computer programs including, but not limited to, the exclusive right to copy or reproduce in any form the copyrighted computer program. Accordingly, any copyrighted Motorola computer programs contained in the Motorola products described in this manual may not be copied, reproduced, modified, reverse-engineered, or distributed in any manner without the express written permission of Motorola. Furthermore, the purchase of Motorola products shall not be deemed to grant either directly or by implication, estoppel, or otherwise, any license under the copyrights, patents or patent applications of Motorola, except for the normal non-exclusive license to use that arises by operation of law in the sale of a product.

---

## Documentation Copyrights

No duplication or distribution of this document or any portion thereof shall take place without the express written permission of Motorola. No part of this manual may be reproduced, distributed, or transmitted in any form or by any means, electronic or mechanical, for any purpose without the express written permission of Motorola.

---

## Disclaimer

The information in this document is carefully examined, and is believed to be entirely reliable. However, no responsibility is assumed for inaccuracies. Furthermore, Motorola reserves the right to make changes to any products herein to improve readability, function, or design. Motorola does not assume any liability arising out of the applications or use of any product or circuit described herein; nor does it cover any license under its patent rights, nor the rights of others.

# Getting Started

## How to Use This Guide

This User Guide covers the basic operation of the APX Portables.

However, your dealer or system administrator may have customized your radio for your specific needs. Check with your dealer or system administrator for more information.

## Notations Used in This Manual

Throughout the text in this publication, you will notice the use of **Warning**, **Caution**, and **Note**. These notations are used to emphasize that safety hazards exist, and the care that must be taken or observed.



### Warning

An operational procedure, practice, or condition and so on, which may result in injury or death if not carefully observed.



### Caution

An operational procedure, practice, or condition and so on, which may result in



damage to the equipment if not carefully observed.





### Note

An operational procedure, practice, or condition and so on, which is essential to emphasize.

The following special notations identify certain items.

Example	Description
<b>Home</b> button or 	Buttons and keys are shown in bold print or as an icon.
Phon	Menu entries are shown similar to the way they appear on the display of the radio.
	This means “Press the right side of the 4-Way Navigation Button”.
	This means the content mentioned besides this icon is designated for radio with <b>Multi-Function Knob (MFK)</b> .

Example	Description
	 <p><b>Note</b> Single knob radio is available for APX 1000 all bands.</p>
	<p>This means the content mentioned besides this icon is designated for radio with <b>Volume Control Knob</b> and <b>16-Position Select Knob</b>.</p>  <p><b>Note</b> Two knobs radio is only available for APX 1000 900 MHz.</p>

indication e.g. failure detection, fault recovery, and redundancy within the system to address to the user in need. Mechanisms related to the Integrated Voice and Data (IV&D) or data centric are all supported by DSR.

### CrossTalk Prevention

This feature prevents crosstalk scenarios from happening, especially when a wideband antenna is used. This feature allows the adjustment of the internal SSI clock rate of the radio. This subsequently reduces the possibility of radio frequency interfering spurs and prevents the issues of crosstalk.

### SecureNet

SecureNet allows user to perform secured communications on an Analog or Motorola Data Communication (MDC) channel.

### Conventional Talkgroup and Radio Scan Enhancements

A few enhancements have been made to the Conventional Talkgroup at the system. These enhancements improve the Scan feature operation significantly when multiple agencies are using a single conventional radio frequency channel. These enhancements allow users to use Selective Squelch

## Additional Performance Enhancement

The following performance enhancements are some of the latest creations designed to enhance the security, quality and efficiency of the radios.

### Dynamic System Resilience (DSR)

DSR ensures the radio system is seamlessly switched to a backup master site dynamically in case of system failure. DSR also provides additional

to operate on only the subset of talkgroups that are relevant to the users rather than all talkgroups on the channel. These Scan improvements have been made to eliminate the audio holes that were present and to turn on the busy LED when activity is present on the channel. Mixed Vote Scan and Standard Conventional Scan configurations are supported. Priority Operation is also supported.

Up to 30 different talkgroups can be supported using conventional channels. A maximum of four talkgroups can be supported when Vote Scan channels are being used.

Smart **PTT** is supported with this enhancement as Smart **PTT** prevents users from transmitting while other users are on the channel.

**Note**

User Selectable Talkgroups are not compatible with this Conventional Talkgroup Enhancement.

operated in extreme temperatures (less than -30 °C or more than +60 °C).

You can consult your dealer or system administrator about the following:

- Is your radio programmed with any preset conventional channels?
- Which buttons have been programmed to access other features?
- What optional accessories may suit your needs?

**Note**

Specifications may vary for different radio models. Check with your dealer or system administrator for more information.

## What Your Dealer/System Administrator Can Tell You

---

Check with your dealer or system administrator for the correct radio settings, if the radio is to be

## Preparing Your Radio for Use

This section provides simple instructions to prepare your radio for use.

### Charging the Battery



#### Warning

To avoid a possible explosion:

- Do **not** replace the battery in any area labeled **hazardous atmosphere**.
- Do **not** discard batteries in a fire.

The Motorola-approved battery shipped with your radio is uncharged. Prior to using a new battery, charge it for a minimum of 16 hours to ensure optimum capacity and performance. For a list of Motorola-authorized batteries and chargers available for use with your radio, see [Accessories](#) on page 125.



#### Note

When charging a battery attached to a radio, turn the radio off to ensure a full charge.

To charge the battery, place the battery (with or without the radio) in a Motorola-approved charger.

The LED on the charger indicates the charging progress; see the charger user guide.

### Attaching the Battery

You can view the status of the IMPRES™ battery if the radio is using an IMPRES battery. See [IMPRES Battery Annunciator](#) on page 116 for more information.

- 1 Slide the battery into the radio frame until the latch which is at the bottom of the radio clicks into place.



See the following picture for **MFK** radio.

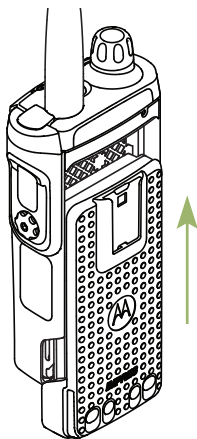

See the following picture for **two knobs** radio.

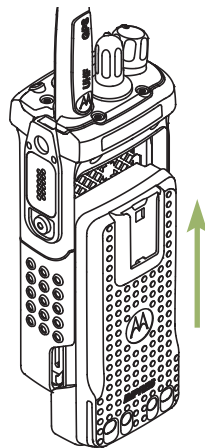

- 2 To remove the battery, lift up the latch **A** which is at the bottom of the radio, then slide the battery out from the radio.



**Note**

When removing the battery, ensure that the radio is turned off.





See the following picture for **MFK** radio.

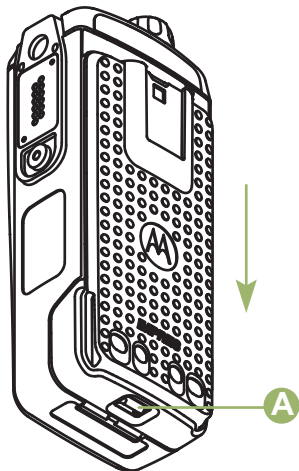

See the following picture for **two knobs** radio.

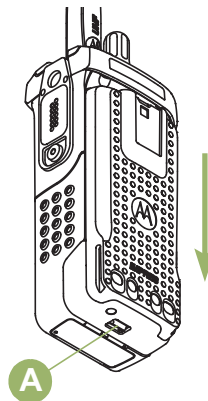

---

## Attaching the Antenna

---

Ensure the radio is turned off before attaching the antenna.

- 1 Set the antenna in its receptacle.
  - 2 Turn the antenna clockwise to attach to the radio.
-



See the following picture for **MFK** radio.

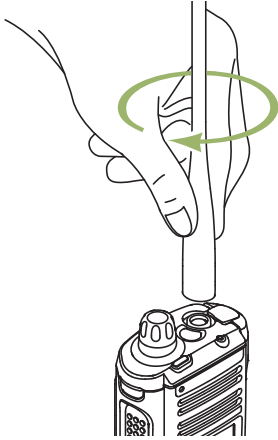

See the following picture for **two knobs** radio.

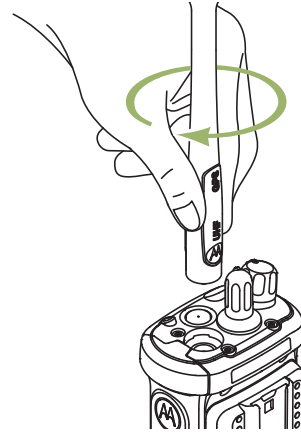

- 
- 3** To remove the antenna, turn the antenna counterclockwise.



**Note**

When removing the antenna, ensure that the radio is turned off.

---

## Removing and Attaching the Accessory Connector Cover

The accessory connector is on the antenna side of the radio. It is used to connect accessories to the radio.



### Note

To prevent damage to the connector, shield it with the connector cover when not in use.

- 1 To remove the accessory connector cover, rotate the thumbscrew **B** counterclockwise until it disengages from the radio.



### Note

If the thumbscrew is too tight, use an Allen wrench at **C** to loosen it first.



See the following picture for **MFK** radio.

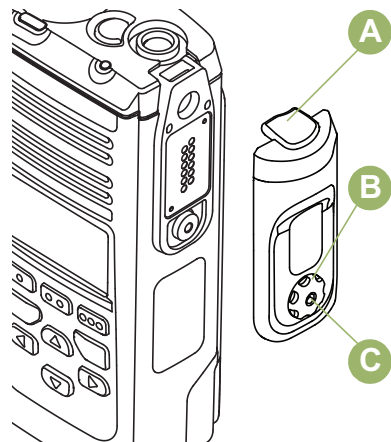



See the following picture for **two knobs** radio.

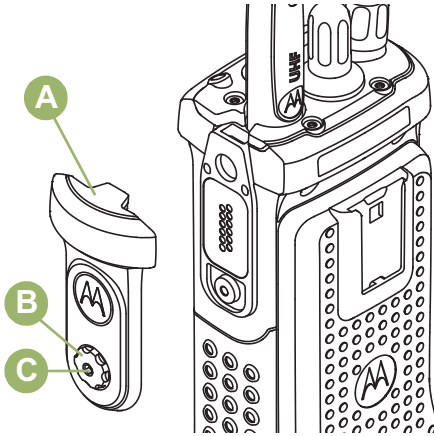

- 2 Rotate and lift the connector cover to disengage it from the radio.
- 3 To attach the accessory connector cover, insert the hooked end **A** of the cover into the slot above the connector.

- 4 Press downward on the cover's top to seat it in the slot.
- 5 Once in place, tighten by rotating the thumbscrew **B** clockwise by hand.

## Attaching the Belt Clip

- 1 Align the grooves of the belt clip with those of the radio and push down until you hear a click.



See the following picture for **MFK** radio.

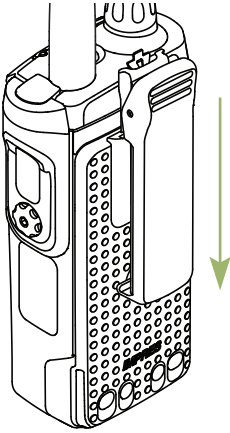

See the following picture for **two knobs** radio.

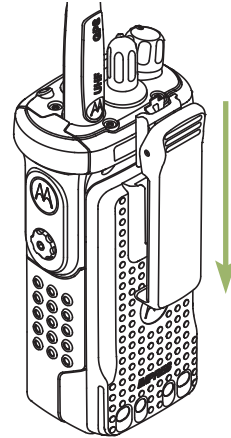

- 2 To remove the clip, use a flatbladed object to press the belt clip tab **(A)** away from the radio. Then, slide the clip upward and away from the radio.



See the following picture for **MFK** radio.

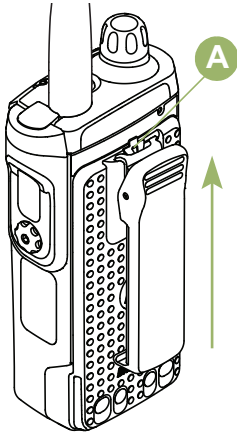

See the following picture for **two knobs** radio.

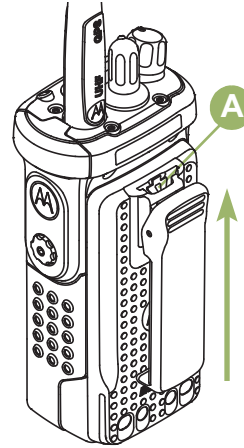

---

## Turning On the Radio

---

- 1 Select one of the following actions based on the radio models you are using.
  -  Press the **Multi-Function Knob** until the radio display lights on, then release the knob.

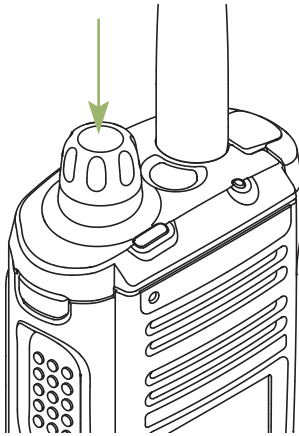

- 
 Rotate the **On/Off/Volume Control Knob** clockwise until you hear a click.

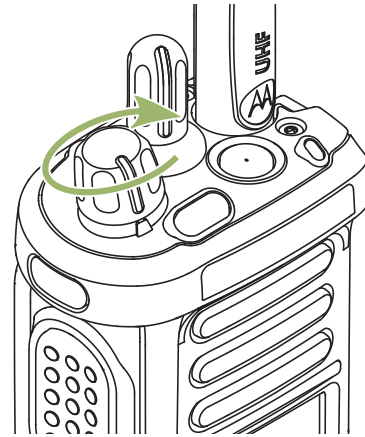

- If the power-up test is successful, you see momentary `SELFTEST` on the radio display, followed by the Home screen.
- If the power-up test is unsuccessful, you see `Error XX/YY` (`XX/YY` is an alphanumeric code).



### Note

If the radio fails to power-up after repeating a few times, record the Error XX/YY code and contact your dealer.

- 2 Select one of the following actions based on the radio models you are using.



To turn off the radio, press and hold the **Multi-Function Knob** until the radio display shows Power off?, press the **Menu Select** button below Yes to power off.

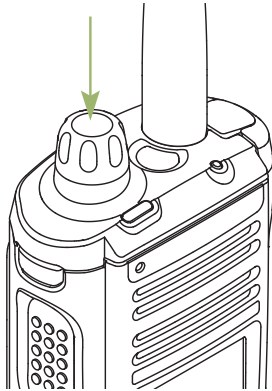

To turn off the radio, rotate the **On/Off/Volume Control Knob** counterclockwise until you hear a click.

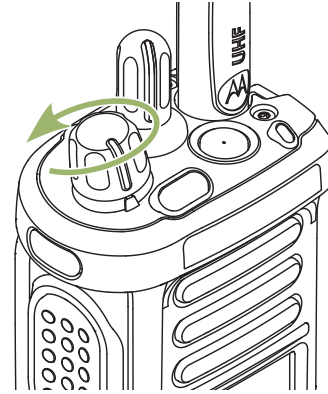

## Adjusting the Volume

Ensure the radio is power on and the main speaker is pointed towards you for increased loudness and intelligibility, especially in areas with loud background noises.



Your radio is preprogrammed to reset to medium volume rate, which is Level 12, by default whenever the radio powers up.

1 Select one of the following actions based on the radio models you are using.



To increase the volume, rotate the **Multi-Function Knob (A)** clockwise.

A

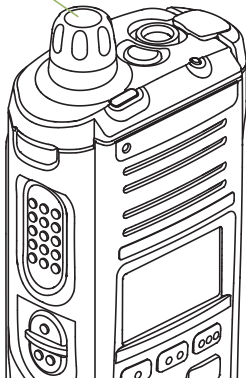

To increase the volume, rotate the **On/Off/Volume Control Knob (A)** clockwise.

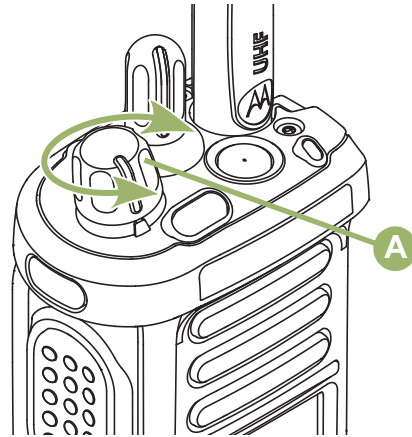

2 To decrease the volume, rotate this knob counterclockwise.

The display shows volume bars and volume level when you change the volume.

## Identifying Radio Controls

### Radio Parts and Controls



APX 1000 with Multi-Function Knob (MFK).

**Note**

Single knob radio is available for APX 1000 all bands.

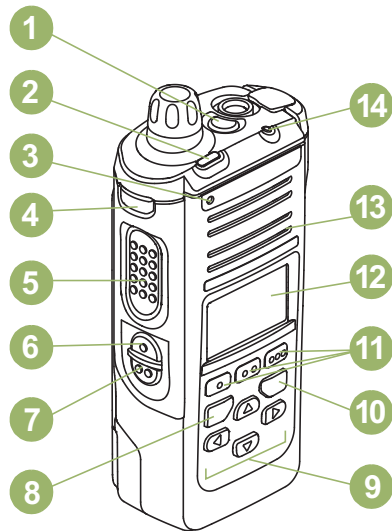

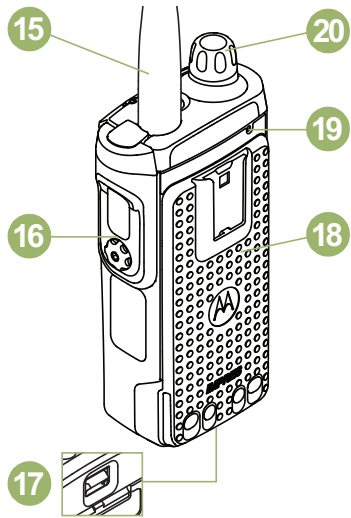

1	Top (Orange) Button <sup>[1]</sup>
2	Top Lightbar
3	Microphone
4	Top Side (Select) Button <sup>[1]</sup>
5	Push-to-Talk (PTT) Button
6	Side Button 1 <sup>[1]</sup>

7	Side Button 2 <sup>[1]</sup>
8	Home Button
9	4-Way Navigation Button
10	Data Feature Button
11	Menu Select Buttons
12	Main Display
13	Speaker
14	LED
15	Antenna
16	Accessory Connector
17	Battery Latch (at the bottom)
18	Battery
19	Microphone
20	Multi-Function Knob (MFK) <sup>[1]</sup>



APX 1000 with two knobs.



### Note

Two knobs radio is only available for APX 1000 900 MHz.

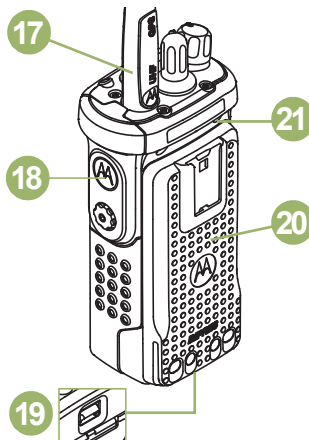

1	16-Position Select Knob <sup>[1]</sup>
2	On/Off/Volume Control Knob
3	Top Lightbar
4	Top Side (Select) Button <sup>[1]</sup>
5	Microphone
6	Push-to-Talk (PTT) Button
7	Side Button 1 <sup>[1]</sup>

8	Side Button 2 <sup>[1]</sup>
9	Home Button
10	4-Way Navigation Button
11	Data Feature Button
12	Menu Select Buttons
13	Main Display
14	Speaker
15	LED
16	Top (Orange) Button <sup>[1]</sup>
17	Antenna
18	Accessory Connector
19	Battery Latch
20	Battery
21	Microphone

<sup>1</sup> These radio controls/buttons are programmable.

## Programmable Features

Any reference in this manual to controls that are preprogrammed means that a qualified radio technician must use the radio programming software to assign a feature to a control.

Your dealer can program the programmable buttons as shortcuts to radio functions or preset channels/ groups depending on the duration of a button press:

**Press** Pressing and releasing rapidly.

**Long press** Pressing and holding for the preprogrammed duration (between 0.25 seconds and 3.75 seconds).

**Hold down** Keeping the button pressed.

## Assignable Radio Functions

**Call Alert** Allows the radio to function like a pager, or to verify if a radio is active on the system.

**Call Response** Allows you to answer a private call.

<b>Channel</b>	Selects a channel.	<b>Message</b>	Enters the current message list.
<b>Contacts</b>	Selects the Contacts menu.	<b>Mode Select</b>	Long-press programs a button with the current zone and channel of the radio; once programmed, the short-press of that button changes the radio zone channel to the programmed zone and channel.
<b>Dynamic Priority (Conventional Only)</b>	Allows any channel in a Scan List (except for the Priority-One channel) to temporarily replace the Priority-Two channel.	<b>Monitor (Conventional Only)</b>	Monitors a selected channel for all radio traffic until function is disabled.
<b>Emergency</b>	Depending on the programming, initiates or cancels an emergency alarm or call.	<b>Multiple Private Line (Conventional Only)</b>	Selects the Multiple Private Line lists.
<b>Information</b>	Displays the information of the radio.	<b>Nuisance Delete</b>	Temporarily removes an unwanted channel, except for priority channels or the designated transmit channel from the scan list.
<b>Internet Protocol Address</b>	Display the Internet Protocol (IP) address, device name and status of the radio.		
<b>Location</b>	Determines the current location (latitude, longitude, time and date), and also the distance and bearing to another location. Or, turns the GPS functionality on or off for all locations.		

<b>Phone</b>	Allows you to make and receive calls similar to standard phone calls.	<b>Request-To-Talk (Conventional Only)</b>	Notifies the dispatcher you want to send a voice call.
<b>Private Call (Trunking Only)</b>	Allows a call from an individual radio to another individual radio.	<b>Scan</b>	Toggles scan on or off.
<b>Private Line Defeat (Conventional Only)</b>	Overrides any coded squelch (DPL or PL) that is preprogrammed to a channel.	<b>Scan List Programming</b>	Selects the scan list for editing (by long press on the Scan button).
<b>Radio Profiles</b>	Allows easy access to a set of preprogrammed visual and audio settings of the radio.	<b>Secure Transmission Select (Conventional and Trunking)</b>	Toggles the Secure Transmission On or Off when the Secure/Clear Strapping fields is set to <code>Select</code> for the current channel and when the radio is model/option capable.
<b>Recent Calls</b>	Allows easy access to the list of calls recently received or made.	<b>Selective Call (Conventional Only)</b>	Calls an assigned radio.
<b>Repeater Access Button (RAB) (Conventional Only)</b>	Allows user to manually send a repeater access codeword.	<b>Site Display/Search (Trunking Only)</b>	Displays the current site ID and RSSI value; performs site search for Automatic Multiple Site Select (AMSS) or SmartZone operation.
<b>Reprogram Request (Trunking Only)</b>	Notifies the dispatcher you want a new dynamic regrouping assignment.	<b>Site Lock/Unlock (Trunking Only)</b>	Locks onto a specific site.

<b>Status (Astro 25 Trunking Only)</b>	Sends data calls to the dispatcher about a predefined status.
<b>Talkaround/Direct (Conventional Only)</b>	Toggles between using a repeater and communicating directly with another radio.
<b>Talkgroup (Conventional Only)</b>	Allows a call from an individual radio to a group of radios.
<b>Text Messaging Service (TMS)</b>	Selects the text messaging menu.
<b>TMS Quick Text User</b>	Selects a predefined message. Automatically registers with the server.
<b>Zone Select</b>	Allows selection from a list of zones.

### Assignable Settings or Utility Functions

<b>Keypad/Controls Lock</b>	Locks or unlocks the keypad, programmable buttons, switches or rotary knobs.
-----------------------------	--

<b>Light/Flip</b>	Press the button to toggle the display backlight on or off; press and hold the button to reverse the content of the top display.
<b>Voice Announcement</b>	Audibly indicates the current feature mode, Zone or Channel the user has just assigned.
<b>Voice Mute</b>	Toggles voice mute on or off.
<b>Volume Set Tone</b>	Sets the volume set tone.

### Accessing the Preprogrammed Functions

---

You can access various radio functions through one of the following methods.

- A short or long press of the relevant programmable buttons.
- 
- Use the **Menu Select** Button.
- 
- Use the **Menu Select** and **Navigation** buttons.





See the following illustration for APX with MFK.

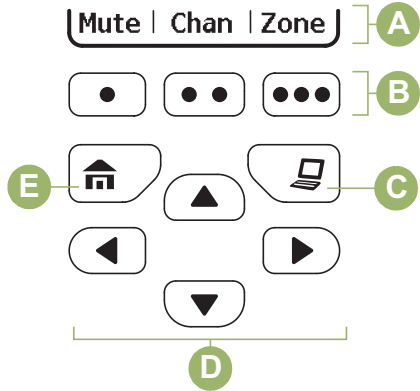

See the following illustration for APX with two knobs.

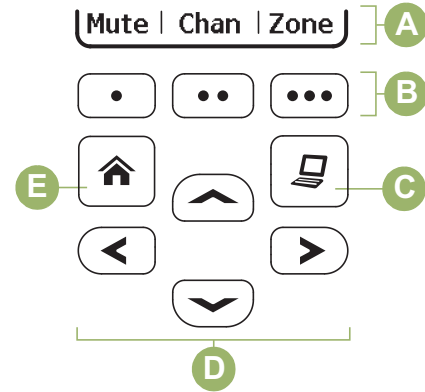

A	Softkeys
B	Menu Select Buttons
C	Data Feature Button
D	4-Way Navigation Button
E	Home Button

## Menu Select Buttons





### Note

Check with your dealer or system administrator for the list of features activated in your radio.

Use the **Menu Select** button to access the menu entry of your radio feature. Your radio may be preprogrammed differently from the following example, but the steps for selecting a channel may appear as shown below:

Press the **Menu Select** button directly below Chan.

## Home Button

Pressing the  button returns you to the Home (default) screen. In most cases, this is the current mode. For selected radio features, the  button is also used to save user-edited radio settings or information before returning you to the Home screen.



### Note

Some features do not require you to press  to go to the Home screen. Refer to the individual feature sections in this manual for further details on saving user-edited radio settings or information.

## 4-Way Navigation Button

Use the **4-Way Navigation Button** to scroll up, down, left or right with one of the following methods.

- Press and release one of the button to scroll from one entry to the next one.
- Press and hold one of the button to have the radio toggles through the list automatically (release the button to stop).

## Data Feature Button

Use **Data Feature** button to access data-related features, such as the Text Messaging Service (TMS) feature screen.



## Multi-Function Knob (MFK)

**MFK** is the on/off button of your radio. See [Turning On the Radio](#) on page 26 for the procedure to power up and down the radio.

In addition, there are programmable features available for **MFK**. The two programmable features are as the following.

<b>Mode Change</b>	Turn <b>MFK</b> to scroll the channel or zone list.
--------------------	---



## Volume Change



Turn **MFK** to increase or decrease the volume level of the speaker. Fast turn of **MFK** makes coarse tuning of the volume level; slow turn of **MFK** makes fine tuning of the volume level. The display shows the volume level and bars to indicate the current level. The level of last selected volume before the radio powers down remains the same when the radio powers up.

The radio by default is set to use the primary feature. Short presses of **MFK** toggle it to work on either the secondary or primary feature.

The main display only shows the icon of secondary feature; the main display does not show the icon of primary feature.

The secondary feature has an inactivity timer. This timer starts when the secondary feature is left idle. Your radio returns to primary feature when this timer expires.

If the **MFK** is set to operate only one feature besides On/Off the radio, Volume Change should be the only feature applied to **MFK**.

Consult your dealer or system administrator for the best options available for **MFK**.

## Push-To-Talk (PTT) Button



See the following picture for **MFK** radio.

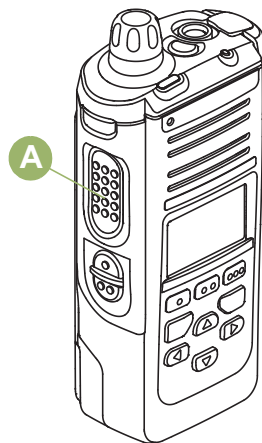



See the following picture for **two knobs** radio.

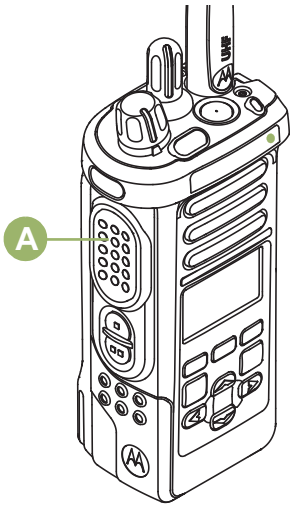

The **PTT** button **A** on the side of the radio serves two basic purposes:

- While a call is in progress, the **PTT** button allows the radio to transmit to other radios in the call.



Press and hold down **PTT** button to talk. Release the **PTT** button to listen. The microphone is activated when the **PTT** button is pressed.





- While a call is not in progress, the **PTT** button is used to make a new call. See [Methods to Make a Radio Call](#) on page 59 for more information.



## Identifying Status Indicators





### Status Icons

The 160 x 90 pixel front liquid crystal display (LCD) of your radio shows radio status, text entries, and menu entries. The top two display rows contain color icons that indicate radio operating conditions.

	<p><b>Receiving</b></p> <p>Radio is receiving a call or data.</p>
	<p><b>Transmitting</b></p> <p>Radio is transmitting a call or data.</p>
	<p><b>Battery</b></p> <p>For IMPRES™ battery operation only – the icon shown indicates the charge remaining in the battery.</p> <p>For all battery operation – the icon blinks when the battery is low.</p>

	<p><b>Received Signal Strength Indicator (RSSI)</b></p> <p>The number of bars displayed represents the received signal strength for the current site, for trunking only. The more stripes in the icon, the stronger the signal.</p>
	<p><b>Roaming</b></p> <p>The radio has roamed to and is currently registered to a foreign system.</p>
	<p><b>Direct</b></p> <p><b>On</b> – Radio is currently configured for direct radio-to-radio communication (during conventional operation only).</p> <p><b>Off</b> – Radio is connected with other radios through a repeater.</p>
	<p><b>Monitor (Carrier Squelch)</b></p> <p>Selected channel is being monitored (during conventional operation only).</p>

	<p><b>In-Call User Alert</b></p> <p><b>On</b> – The feature is enabled. Voice muting of the affiliated trunking talkgroup or selected conventional channel is activated.</p> <p><b>Off</b> – The feature is disabled. Voice muting of the affiliated trunking talkgroup or selected conventional channel is deactivated.</p>
<b>H</b> or <b>L</b>	<p><b>Power Level</b></p> <p><b>L</b> – Radio is set at Low power.</p> <p><b>H</b> – Radio is set at High power.</p>
	<p><b>Scan</b></p> <p>Radio is scanning a scan list.</p>
	<p><b>Priority Channel Scan</b></p> <p><b>Blinking dot</b> – Radio detects activity on channel designated as Priority-One.</p> <p><b>Steady dot</b> – Radio detects activity on channel designated as Priority-Two.</p>

	<p><b>Vote Scan Enabled</b></p> <p>The vote scan feature is enabled.</p>
	<p><b>Secure Operation</b></p> <p><b>On</b> – Secure operation.</p> <p><b>Off</b> – Clear operation.</p> <p><b>Blinking</b> – Receiving an encrypted voice call.</p>
	<p><b>GPS Signal</b></p> <p><b>On</b> – Feature is enabled and signal is available.</p> <p><b>Off</b> – Feature is disabled.</p> <p><b>Blinking</b> – Feature is enabled, but no signal is available.</p>
	<p><b>User Login Indicator (IP Packet Data)</b></p> <p><b>On</b> – User is currently associated with the radio.</p> <p><b>Off</b> – User is currently not associated with the radio.</p>

**Blinking** – Device registration or user registration with the server failed due to an invalid username or pin.

**Inverted** – User successfully login to the secured IP Packet Data.



#### Data Activity

Data activity is present.

## Text Messaging Service (TMS) Indicators

This feature allows you to send and receive text messages. Status icons and menu options shown here help you to work more efficiently with TMS feature. See [Text Messaging Service \(TMS\)](#) on page 85 for more information.

### TMS Status Icons

The following icons appear on the radio's display when you send and receive text messages.



#### Inbox Full

The Inbox is full.



#### Message Sent

The text message is sent successfully.



#### Message Unsent

The text message cannot be sent.



#### Unread Message

- User receives a new message.
- The selected text message in the Inbox has not been read.



#### Read Message

The selected text message in the Inbox has been read.



#### Normal Message

User is composing a message with normal priority and without a request for a reply.



#### Message Index

Indicates the index of the current message the user is viewing.

Example: If the user is looking at the third message out of a total of 6 messages in the Inbox folder, the icon is displayed as the icon on the left column.



### Priority Status

- The “Priority” feature is toggled on before the message is sent.
- Messages in the Inbox folder are flagged with “Priority”.



### Request Reply

- The “Request Reply” feature is toggled on before the message is sent.
- Messages in the Inbox folder are flagged with “Request Reply”.



### Priority Status and Request Reply

- User is composing a message with a priority status and a request for a reply.
- Messages in the Inbox folder are flagged with “Priority” and “Request Reply”.









## TMS Menu Options

Menu Option	Description/Function
Back	Brings you back to the previous screen.
Clr	Deletes all messages.
Del	Deletes a message or text.
Exit	Exits to the Home screen.
No	Returns to the previous screen.
Optn	Brings you to the Options main screen.
Rply	Replies to a message.
Sel	Selects the highlighted command.
Send	Sends the message.
Yes	Updates or saves a command.

## Call Type Icons

The following icons appear on the radio’s main display, when you make or receive a call, or view selected call lists, to indicate the different call types associated with an alias or ID.



	Radio number.
	Radio number added to a Call List.
	Mobile number.
	Mobile number added to a Call List.
	Landline phone number.
	Landline phone number added to a Call List.
	Incoming call or data.
	Outgoing call or data.
	Incoming emergency call.

## LED Indicator

The LED indicator  shows the operational status of your radio.



See the following picture for **MFK** radio.

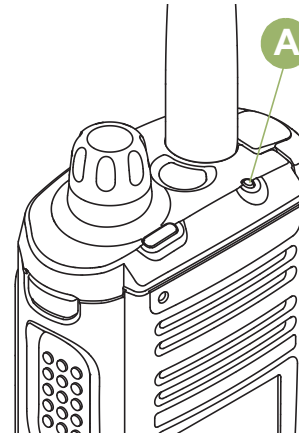

See the following picture for **two knobs** radio.

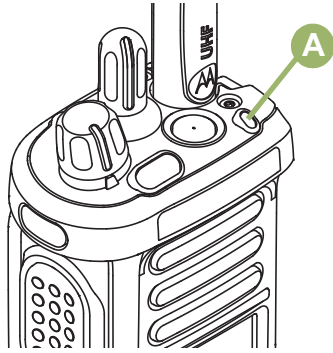

- Solid red**                      Radio is transmitting.
- Blinking red**                 Radio is transmitting at low battery condition.
- Double blinking red**        Radio is in Emergency Mode.
- Rapidly blinking red**        Radio has failed the self test upon powering up or encountered a fatal error.
- Solid yellow (Conventional Only)**      Channel is busy.

- Blinking yellow**            Radio is receiving a secured transmission.
- Solid green**                 Radio is powering up, or is on a non-priority channel while in the Scan List Programming mode.
- Blinking green**             Radio is receiving an individual or telephone call, or is on a Priority-Two channel while in the Scan List Programming mode.
- Rapidly blinking green**      Radio is on a Priority-One channel while in the Scan List Programming mode.



**Note**  
 No LED indication when the radio receives a clear (non-secured) transmission in trunking Mode. LED indication can be preprogrammed by qualified technician to be permanently disabled. Consult your dealer for further details if you want to disable it.

## Top Lightbar Indicator

---



See the following picture for **MFK** radio.

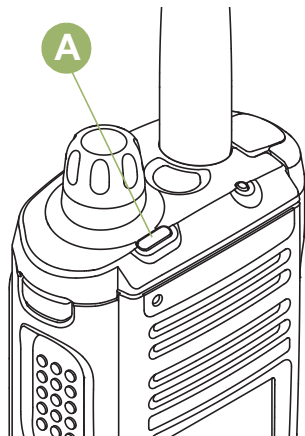

See the following picture for **two knobs** radio.

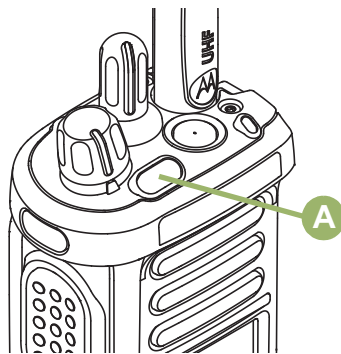

The Top Lightbar **A** indicates the secondary function of MFK and also the status of Intelligent Lighting.

The lightbar blinks green when the MFK is using the secondary feature. See [Multi-Function Knob \(MFK\)](#) on page 38 to understand the functionality of MFK.

The lightbar turn into solid color of orange, red or green depending on the status of Intelligent Lighting. See [Intelligent Lighting Indicators](#) on page 48 for different status of Intelligent Lighting.

## Intelligent Lighting Indicators

This feature temporarily changes the color of the **Top Lightbar** and adds a color bar to the main display screen to help signal that a radio event has occurred.



### Note

This feature must be preprogrammed by a qualified radio technician.

Backlight and Bar Color	Notification	When
<b>Orange</b>	<b>Emergency Alerts</b>	The radio initiates an emergency alarm or call.
		The radio receives an emergency alarm or call.
<b>Red</b>	<b>Critical Alerts</b>	The radio battery is low.
		The radio is out of range.
		The radio enters Failsoft mode.
		The radio is unable to establish a full connection with the system.
		The radio is unable to authenticate or register with the system.
<b>Green</b>	<b>Call Alerts</b>	The radio lost GPS signal or GPS function fails.
		The radio receives a private call.
		The radio receives a phone call.
		The radio receives a call alert.

Backlight and Bar Color	Notification	When
		The radio receives a selective call.
		The radio enters Geofence.

## Alert Tones

Your radio uses alert tones to inform you of the condition of your radio. The following table lists these tones and when they occur.

You Hear	Tone Name	Heard
<b>Short, Low-Pitched Tone</b>	<b>Radio Self Test Fail</b>	When radio fails its power-up self test.
	<b>Reject</b>	When an unauthorized request is made.
	<b>Time-Out Timer Warning</b>	Four seconds before time out.
	<b>No ACK Received</b>	When radio fails to receive an acknowledgment.
	<b>Individual Call Warning Tone</b>	When radio is in an individual call for greater than 6 seconds without any activity.
<b>Long, Low-Pitched Tone</b>	<b>Time-Out Timer Timed Out</b>	After time out.
	<b>Talk Prohibit/PTT Inhibit</b>	(When <b>PTT</b> button is pressed) transmissions are not allowed.



You Hear	Tone Name	Heard
	<b>Lack of Voice PTT Time out</b>	When the radio ends your call after it detected there are lack of voice for 5 seconds after the PTT is pressed and hold. Your radio ends the call to enable your radio to receive calls from other radio users.
	<b>Out of Range</b>	(When <b>PTT</b> button is pressed) the radio is out of range of the system.
	<b>Invalid Mode</b>	When radio is on an unpreprogrammed channel.
<b>A Group of Low-Pitched Tones</b>	<b>Busy</b>	When system is busy.
<b>Short, Medium-Pitched Tone</b>	<b>Valid Key-Press</b>	When a correct key is pressed.
	<b>Radio Self Test Pass</b>	When radio passes its power-up self test.
	<b>Clear Voice</b>	At beginning of a non-coded communication.
	<b>Priority Channel Received</b>	When activity on a priority channel is received.
	<b>Emergency Alarm /Call Entry</b>	When entering the emergency state.
	<b>Central Echo</b>	When central controller has received a request from a radio.
<b>Long, Medium-Pitched Tone</b>	<b>Volume Set</b>	When volume is changed on a quiet channel.

You Hear	Tone Name	Heard
	<b>Emergency Exit</b>	When exiting the emergency state.
<b>A Group of Medium-Pitched Tones</b>	<b>Failsoft</b>	When the trunking system fails.
	<b>Automatic Call Back</b>	When voice channel is available from previous request.
	<b>Console Acknowledge</b>	When status, emergency alarm, or reprogram request ACK is received.
	<b>Received Individual Call</b>	When Call Alert or Private Call is received.
	<b>Call Alert Sent</b>	When Call Alert is received by the target radio.
<b>Short, High-Pitched Tone (Chirp)</b>	<b>Low-Battery Chirp</b>	When battery is below preset threshold value.
<b>Two High-Pitched Tones</b>	<b>GPS Fails</b>	When the GPS signal is lost or when GPS fails.
<b>Ringing</b>	<b>Fast Ringing</b>	When system is searching for target of Private Call.
	<b>Enhanced Call Sent</b>	When waiting for target of Private Call to answer the call.
	<b>Phone Call Received</b>	When a land-to-mobile phone call is received.
<b>Gurgle</b>	<b>Dynamic Regrouping</b>	(When <b>PTT</b> button is pressed) a dynamic ID has been received.
	<b>Talk Permit</b>	(When <b>PTT</b> button is pressed) is verifying with the system for accepting its transmissions.

You Hear	Tone Name	Heard
Unique, Low-Pitched Chirp	<b>New Message</b>	When a new message is received.
Unique, High-Pitched Chirp	<b>Priority Status</b>	When a priority message is received.
Unique Low-High Tone	<b>MFK Enters Secondary Feature</b>	When <b>MFK</b> is toggled to secondary feature.
Unique High-Low Tone	<b>MFK Exits Secondary Feature</b>	When <b>MFK</b> is toggled to exit secondary feature and return to primary feature or when secondary function timer expires.

## Phone Call Displays and Alerts

The following phone call displays and alerts appears on the radio's display when you make and receive Phone calls. The radio also uses alert tones to indicate the current status.

You Hear	You See	When	Notes
<b>A Long Tone</b>	<b>No phone</b>	<b>You press the PTT button and the phone system is not available.</b>	Press  to hang up. The radio returns to the Home screen.
	<b>Phone busy</b>	<b>The phone system is busy.</b>	Press  to exit the phone mode and try your call later.



You Hear	You See	When	Notes
<b>A Busy Tone</b>	<b>Phone busy</b>	<b>When a channel is not available.</b>	The radio automatically connects when a channel opens.
–	<b>No acknowledge</b>	<b>The call is not acknowledged.</b>	Press  to hang up. The radio returns to the Home screen.
<b>A High- Pitched Tone</b>	–	<b>When you release the PTT button.</b>	The radio indicates to the landline party that he or she may begin talking.

## General Radio Operation

### Selecting a Zone

Your radio must be preprogrammed to allow you to use this feature.

A zone is a group of channels. The following methods are options on how to select a radio zone. The result of all the methods is the same. You can use the options interchangeably depending on your preference and the programmed functions.

- Select a zone via the radio menu Zone:
  - a) ◀ or ▶ to Zone and press the **Menu Select** button directly below Zone.
  - b) ▲ or ▼ to the required zone.
  - c) Press the **Menu Select** button directly below  $\text{Se1}$  to confirm the displayed zone.
  - d) Press the **PTT** button to transmit on the displayed zone channel.
-  Turn the preprogrammed **Zone Change MFK** to the required zone.

If **Mode Change** is secondary feature of the **MFK**, press the **MFK** once to toggle to **Zone Change MFK** then only select the required zone.

- Select a zone via the radio menu ZnUp or ZnDn:
  - a) ◀ or ▶ to ZnUp or ZnDn.
  - b) Press and hold the **Menu Select** button directly below ZnUp or ZnDn until the required zone appears.  
Positions of ZnUp and ZnDn on the display may differ each time you release the **Menu Select** button. Read carefully before you press.
  - c) Press the **PTT** button to transmit on the displayed zone channel.

### Selecting a Radio Channel

A channel is a group of radio characteristics, such as transmit/ receive frequency pairs. The following methods are options on how to select a radio channel. The result of all the methods is the same. You can use the options interchangeably depending on your preference and the programmed functions.

-  Select a channel via the **MFK**:
  - If channel is set as the primary mode, turn the **MFK** until the display shows the desired channel.  
If channel is not set as the primary mode, press the **MFK** once and repeat this step.
  - Press the **PTT** button to begin transmitting on the displayed channel.

-  Select a channel via the preprogrammed **16-Position Select Knob** to the desired channel.
  - Rotate the preprogrammed **16-Position Select Knob** to the desired channel.
  - Press the **PTT** button to transmit on the displayed zone channel.

- Select a channel via the radio menu Chan:
  - ◀ or ▶ to Chan.
  - Press the **Menu Select** button directly below Chan.
  - ▲ or ▼ to the required channel.

- Press the **Menu Select** button directly below Sel to confirm the selected channel.
- Press the **PTT** button to transmit on the displayed zone channel.

- Select a channel via the radio menu Channel Up or Channel Down:
  - ▲ or ▼ to ChUp or ChDn.
  - Press the **Menu Select** button directly below ChUp or ChDn.

Positions of ChUp and ChDn on the display may differ each time you release the **Menu Select** button. Read carefully before you press.

- Press the **PTT** button to transmit on the displayed zone and channel.

## Mode Select Feature

Mode Select allows a long press to save the current zone and channel of your radio to a programmable button, or a softkey; then once programmed, the short-press of that button or softkey changes the transmission to the saved zone and channel.

There are two methods to save the selected zone and channel:

- Softkeys
- Programmable buttons

**Note**

Your radio must be preprogrammed to allow you to use this feature.

### Saving a Zone and a Channel to a Softkey

Five softkeys are available for you to save the frequently used zone and channel.

**1** Toggle your zone and channel to the required zone and channel.

---

**2** ◀ or ▶ to MS1, MS2 ... or MS5.

---

**3** Press and hold the **Menu Select** button directly below one of the softkey (MS1 – MS5).

---

You hear a short, medium-pitched tone when the zone and channel is saved.

**Note**

To change the programmed zone and channel, repeat this procedure.

Short press of the programmed softkey changes your current transmission to the zone and channel programmed in this softkey.

### Saving a Zone and a Channel to a Button

You can save the frequent used zone and channel to the programmable buttons.

**1** Toggle your zone and channel to the required zone and channel.

---

**2** Press and hold the button you desire to program.

---

You hear a short, medium-pitched tone when the zone and channel is saved.

**Note**

Repeat this procedure to change the zone and channel of the programmed button.

Short press of the programmed button changes your current transmission to the zone and channel programmed in this button.

## Receiving and Responding to a Radio Call

---

Once you have selected the required channel and/or zone, you can proceed to receive and respond to calls.

The LED lights up solid red while the radio is transmitting. In conventional mode, the LED lights up solid yellow when the radio is receiving a transmission. In trunking mode, there is no LED indication when the radio receives a transmission.

If the radio is receiving a secure transmission, the LED blinks yellow.

## Receiving and Responding to a Talkgroup Call

To receive a call from a group of users, your radio must be configured as part of that talkgroup.

When you receive a talkgroup call (while on the Home screen) the radio triggers for your attention with one of the following scenarios depending on the system your radio is configured:

- For ASTRO Conventional system, the LED lights up solid yellow. The display shows the talkgroup alias or ID, and the caller alias or ID.

- For Trunking system, the display shows the caller alias or ID.

**1** Hold the radio vertically 1 to 2 inches (2.5 to 5.0 cm) from your mouth.

---

**2** Press the **PTT** button to respond to the call. The LED lights up solid red.

---

**3** Release the **PTT** button to listen.

---

See also [Making a Talkgroup Call](#) on page 59 for details on making a Talkgroup Call.

## Receiving and Responding to a Private Call (Trunking Only)

A Private Call is a call from an individual radio to another individual radio.

The one-to-one call between the two radios are not heard by the others in the current talkgroup. The calling radio automatically verifies that the receiving radio is active on the system and can display the caller ID.



### Note

With the inactivity timer enabled (optional), when there is no response from the receiving radio, the calling radio exits the call with Menu Inactive Exit tone after the timer expires.

When you receive a Private Call, you hear two alert tones and the LED blinks green. The display shows `Call received` and the call received icon blinks.

- 1 Perform one of the following actions:
  - Press the **Menu Select** button directly below `Resp.`
  - Press the **Call Response** button within 20 seconds after the call indicators begin.

If the caller alias is in the call list, the display shows the caller alias during the call.

If the caller name is not in the call list, the display shows the caller ID.

- 
- 2 Press and hold the **PTT** button to talk. Release the **PTT** button to listen.
- 
- 3 Press  or the **Call Response** button to hang up and return to the Home screen.
- 

See also [Making a Private Call \(Trunking Only\)](#) on page 60 for details on making a Private Call.

## Receiving and Responding to a Telephone Call (Trunking Only)

This feature allows you to receive calls similar to standard phone calls from a landline phone.



### Note

With the inactivity timer enabled (optional), if there is no response to the call after the timer expires, your radio exits the call with Menu Inactive Exit tone.



When you receive a Telephone Call, you hear a telephone-type ringing and the LED blinks green. The display shows `Phone Call` and the call received icon blinks.

- 1 Press the **Call Response** button within 20 seconds after the call indicators begin.
- 
- 2 Press and hold the **PTT** button to talk. Release the **PTT** button to listen.
- 
- 3 Press  or the **Call Response** button to hang up and return to the Home screen.
-

See also [Making a Telephone Call \(Trunking Only\)](#) on page 61 for details on making a Telephone Call.

## Methods to Make a Radio Call

You can select a zone, channel, subscriber ID, or talkgroup by using:

-  **MFK** preprogrammed with Channel Change or Zone Change function.
-  The **16-Position Select Channel Knob**.
- The Contacts list (see [Viewing Details of a Contact](#) on page 71).





### Note

The radio automatically exits the feature, if the feature inactivity timer is enabled, when the radio is left idle and the timer expires. You will hear the Menu Inactive Exit Tone upon feature exit.

## Making a Talkgroup Call

To make a call to a group of users, your radio must be configured as part of that talkgroup.

- 1 Perform one of the following actions.



-  Turn the **MFK** to select the channel with the desired talkgroup.
-  Turn the **16-Position Select Channel Knob** to select the channel with the desired talkgroup.



- 
- 2 Hold the radio vertically 1 to 2 inches (2.5 to 5.0 cm) from your mouth.
- 
- 3 Press the **PTT** button to make the call. The radio shows different indicators based on the system the radio is configured.
    - For ASTRO Conventional system, the LED lights up solid red. The display shows the talkgroup alias or ID.
    - For Trunking system, the LED lights up solid red.
- 
- 4 Speak clearly into the microphone.
- 
- 5 Release the **PTT** button to listen.
-

## Making a Private Call (Trunking Only)

Your radio must be preprogrammed to allow you to use this feature.

This feature allows you to send an individual Call Alert or page if there is no answer from the target radio.

- 1  or  to **Call**, and press the **Menu Select** button directly below **Call**.  
The display shows the last transmitted or received ID.

- 2 To select the required ID, perform one of the following actions:
  - Press the **Menu Select** button directly below **Cnts** to scroll through and select the required ID.
  - Press the **Menu Select** button directly below **LNum** to go to the last number dialed.
  -  or  to the required ID.

- 3 Press the **PTT** button to initiate the Private Call.  
The display shows **Calling... <Number>**.

- 4 Hold the radio vertically 1 to 2 inches (2.5 to 5.0 cm) from your mouth.  
When you are connected, the display shows the ID of the target radio.



If no acknowledgment is received, the display shows **No acknowledge**.

- 5 Press and hold the **PTT** button to talk. Release the **PTT** button to listen.
- 6 Press  to return to the **Home** screen.



## Making an Enhanced Private Call (Trunking Only)

Your radio must be preprogrammed to allow you to use this feature.

This feature allows you to send an individual **Call Alert Page** if there is no answer from the target radio. See [Sending a Call Alert Page](#) on page 76 for more information.

- 1  or  to **Call**, and press the **Menu Select** button directly below **Call**.  
The display shows the last transmitted or received ID.



- 2 To select the required ID, perform one of the following actions:
  - Press the **Menu Select** button directly below `Cnts` to scroll through and select the required ID.
  - Press the **Menu Select** button directly below `LNum` to go to the last number dialed.
  -  or  to the required ID.

---

3 Press the **PTT** button to initiate the Private Call. The display shows `Calling... <Number>`.

---

4 Hold the radio vertically 1 to 2 inches (2.5 to 5.0 cm) from your mouth. When you are connected, the display shows the ID of the target radio.

If no acknowledgment is received, the display shows `No acknowledge`.

If the target radio does not respond before the time out, the display shows `No answer`.

---



5 Press and hold the **PTT** button to talk. Release the **PTT** button to listen.

---

6 Press  to return to the **Home** screen.



## Making a Telephone Call (Trunking Only)

This feature allows you to make calls similar to standard phone calls to a mobile or landline phone.

- 1  or  to `Phon`, and press the **Menu Select** button directly below `Phon`. The display shows the last transmitted or received ID.

---

- 2 To select the required ID, perform one of the following actions:

- Press the **Menu Select** button directly below `Cnts` to scroll through and select the required ID.
- Press the **Menu Select** button directly below `LNum` to go to the last number dialed.
-  or  to the required phone number.

---

- 3 Press the **PTT** button to dial the phone number.

---

- 4 Hold the radio vertically 1 to 2 inches (2.5 to 5.0 cm) from your mouth.

---

- 5 When your call is answered, press and hold the **PTT** button to talk. Release the **PTT** button to listen.

6 Press  to return to the **Home** screen.

See *Phone Call Displays and Alerts* on page 52 for more information if your call is NOT answered.



## Switching Between Repeater or Direct Operation Button

---

The **Repeater Operation** increases the radio coverage area by connecting with other radios through a repeater. The transmit and receive frequencies are different.

The **Direct** or “talkaround operation” allows you to bypass the repeater and connect directly to another radio. The transmit and receive frequencies are the same.

Perform one of the following actions:

- Press the preprogrammed **Repeater/Direct** switch to toggle between talkaround and repeater modes.
-  or  to **Dir** and press the **Menu Select** button directly below **Dir**.

The display shows **Repeater mode** if the radio is currently in Repeater mode.

The display shows **Direct mode** and the Talkaround icon if the radio is currently in Direct mode (during conventional operation only).

## Monitor Feature

---

Radio users who switch from analog to digital radios often assume that the lack of static on a digital channel is an indication that the radio is not working properly. This is not the case.

Digital technology quiets the transmission by removing the noise from the signal and allows only the clear voice or data information to be heard.

Use the Monitor feature to make sure a channel is clear before transmitting.

### Monitoring a Channel

The following methods are options on how to monitor a channel. The result of all the methods is the same. You can use the options interchangeably depending on your preference and the programmed functions.

- Monitoring a Channel with **Monitor** button.

- a) Press the preprogrammed **Monitor** button.
- b) Adjust the **Volume Control Knob** if necessary.
- c) Press and hold the **PTT** button to transmit.  
The LED lights up solid red.
- d) Release the **PTT** button to receive (listen).  
The Carrier Squelch indicator appears on the display when you monitor a channel via the preprogrammed **Monitor** button.

- 
- Monitoring a Channel via the selected zone channel.
    - a) Select the desired zone and channel.
    - b) Listen for a transmission.
    - c) Adjust the **Volume Control Knob** if necessary.
    - d) Press and hold the **PTT** button to transmit.  
The LED lights up solid red.
    - e) Release the **PTT** button to receive (listen).
- 

### Monitoring Conventional Mode

Your radio may be preprogrammed to receive Private-Line® (PL) calls.

- 1 Momentarily press the **Monitor** button to listen for activity.

The Carrier Squelch indicator appears on the display.

---

- 2 Press and hold the **Monitor** button to set continuous monitor operation.  
The duration of the button press is programmable.
- 
- 3 Press the **Monitor** button again, or the **PTT** button, to return to the original squelch setting.  
If you try to transmit on a receive-only channel, you hear an invalid tone until you release the **PTT** button.
-

---

## Advanced Features

### Advanced Call Features

---

#### Selective Call (ASTRO Conventional Only)

This feature allows you to receive a call from or to call a specific individual. It is intended to provide privacy and to eliminate the annoyance of having to listen to conversations that are of no interest to you.

#### *Receiving a Selective Call*

When you receive a Selective Call, the radio initiates for your attention with one of the following indication scenario:



- You hear two alert tones and the LED lights up solid yellow to indicate the transmitting radio is still sending signal. The call received icons blinks and the display shows `Call received`.
- The LED blinks solid green once to indicate the transmitting radio is pending to receive signal.



The speaker unmutes.

- 1 Hold the radio vertically 1 to 2 inches (2.5 to 5.0 cm) from your mouth.
- 

- 2 Press and hold the **PTT** button to talk. Release the **PTT** button to listen.
- 

#### *Making a Selective Call*

- 1  or  to `Call`, and press the **Menu Select** button directly below `Call`.  
The display shows the last transmitted or received ID.
- 

- 2 To select the required ID, perform one of the following actions:
    - Press the **Menu Select** button directly below `Cnts` to scroll through and select the required ID.
    - Press the **Menu Select** button directly below `LNum` to go to the last number dialed.
    -  or  to the required ID.
- 

- 3 Hold the radio vertically 1 to 2 inches (2.5 to 5.0 cm) from your mouth.
- 

- 4 Press and hold the **PTT** button to start the Selective Call.  
The display shows the ID of the target radio.
-

5 Release the **PTT** button to listen.

---



6 Press  to return to the **Home** screen.

---

### Talkgroup Call Feature (Conventional Operation Only)

This feature allows you to define a group of conventional system users so that they can share the use of a conventional channel.





#### Selecting a Talkgroup

1  or  to **Tgrp** and press the **Menu Select** button directly below **Tgrp**.

The display shows the last Talkgroup that was selected and stored.

---

2 Perform one of the following actions:

-  or  to **Preset** for the preset preprogrammed Talkgroup.
  -  or  to the required Talkgroup.
- 

3 Press the **Menu Select** button directly below **Sel** to save the currently selected Talkgroup and return to the **Home** screen.

---

4 Press  to return to the **Home** screen.

---

### Sending a Status Call

This feature allows you to send data calls to the dispatcher about a predefined status.



Each status can have up to a 14-character name. A maximum of eight status conditions is possible.



#### Note



The radio automatically exits the feature, if the feature inactivity timer is enabled, when the radio is left idle and the timer expires. You will hear the Menu Inactive Exit Tone upon feature exit.

1 Perform one of the following actions:

- Press the preprogrammed **Status** button.
-  or  to **Sts** and press the **Menu Select** button directly below **Sts**.

The display shows the last acknowledged status call, or the first status in the list.

---

2  or  to the required status.

---

3 Press the **PTT** button to send the status.

When the dispatcher acknowledges, you hear four tones and the display shows `Ack received`. The radio returns to normal dispatch operation.

If no acknowledgment is received, you hear a low-pitched tone and the display shows `No acknowledge`.

- 
- 4 Press  to return to the **Home** screen.

No traffic is heard on trunked channels while Status Calls is selected. If the radio detects no Status Call activity for six seconds, an alert tone sounds until you press  or the **PTT** button.

---

## Responding to the Dynamic Regrouping Feature (Trunking Only)

This feature allows the dispatcher to temporarily reassign selected radios to a particular channel where they can communicate with each other. This feature is typically used during special operations and is enabled by a qualified radio technician.

You will not notice whether your radio has this feature enabled until a dynamic regrouping command is sent by the dispatcher.



### Note

If you try to access a zone or channel that has been reserved by the dispatcher as a dynamically regrouped mode for other users, you hear an invalid tone.

When your radio is dynamically regrouped, it automatically switches to the dynamically regrouped channel. You hear a Gurgle tone and the display shows the dynamically regrouped channel's name.

Press the **PTT** button to talk. Release **PTT** button to listen.

---



When the dispatcher cancels dynamic regrouping, the radio automatically returns to the zone and channel that you were using before the radio was dynamically regrouped.

### *Requesting a Reprogram (Trunking Only)*

This feature allows you to notify the dispatcher when you want a new dynamic regrouping assignment.

Perform one of the following actions:

- Press the preprogrammed **Reprogram Request** button to send reprogram request to the dispatcher.

-  or  to Rpgm then press the **Menu Select** button directly below Rpgm to send reprogram request to the dispatcher.

The display shows Reprgm rqst and Please wait.

If you hear five beeps, the dispatcher has acknowledged the reprogram request. The display shows Ack received and the radio returns to the **Home** screen.

If the dispatcher does not acknowledge the reprogram request within six seconds, you hear a low-pitched alert tone and the display shows No acknowledge. Try again or press  to cancel and return to the **Home** screen.

### ***Classification of Regrouped Radios***

The dispatcher can classify regrouped radios into either of two categories:

**Select Enabled** Select-enabled radios are free to change to any available channel, including the dynamic-regrouping channel, once the user has selected the dynamic-regrouping position.

**Select Disabled** Select-disabled radios cannot change channels while dynamically regrouped. The dispatcher has forced the radio to remain on the dynamic-regrouping channel.

The Scan or Private Call feature cannot be selected while your radio is Select Disabled.

### **Dynamic Zone Programming (DZP)**





#### **Note**

Your radio must be preprogrammed to allow you to use this feature. This feature works on the condition at least one zone in the radio must be a non-dynamic zone.



This feature provides one or more Dynamic Zones to store the frequent used channels be it conventional or trunking. These dynamic channels are saved from pre-existing (non-dynamic) channels in the radio. This saves the time and effort from the regular navigation around the working zones and channels. User can also delete or update the list in the Dynamic Zone.

### Entering the Dynamic Zone to Select a Dynamic Channel

1  or  to Zone then press the **Menu Select** button directly below Zone.

The display shows the **Zone** screen.

---

2  or  to <# Dynamic Zone Channels>.[2]

---

3 Perform one of the following actions:

- Press the **Menu Select** button below Sel to select.
- Press the **Menu Select** button below Exit to exit.



If you have selected one of the Dynamic Zone Channels list, the display returns to **Home** screen with the selected <# Dynamic Zone Channels> shown on the screen.[2]

If you have selected Exit without selecting any Dynamic Zone Channels list, the display returns to **Home** screen without any changes.

---

### Saving a Channel in the Dynamic Zone from List Selection



The radio must be in Dynamic Zone in order to perform this operation.

1  or  to ZnPr. Press the **Menu Select** button directly below ZnPr to enter **Program Zone** screen.



---

2 Press the **Menu Select** button directly below Edit. The display shows **Search Options** screen.



---

3  or  to List Selection. Press the **Menu Select** button directly below Sel. The display shows **Select Zone** screen.

---

4  or  to the required zone. Press the **Menu Select** button directly below Sel. The display shows **Select Chan** screen.

---

5  or  to the required channel. Press the **Menu Select** button directly below Sel. The display shows Channel updated.

---

<sup>2</sup> # indicates number of the channel on the 16-Position Switch which are numbered from 1 to 16.



- Press the **Menu Select** button directly below `Exit` to return to **Home** screen.

---

### **Deleting a Channel in the Dynamic Zone**

The radio must be in Dynamic Zone in order to perform this operation.

- ◀ or ▶ to `ZnPr` then press the **Menu Select** button directly below `ZnPr` to enter **Program Zone** screen.  
The display shows the dynamic channels list.
  - ▲ or ▼ to the saved dynamic channel then press the **Menu Select** button directly below `Del`.  
The display shows **Channel deleted** screen.
  - Press the **Menu Select** button below `Exit` to return to **Home** screen.  
The **Home** screen shows `<Dynamic Zone Channels>`.  
  
If the channel deleted is the Home channel, the **Home** screen shows `<Zone Name>+”Blank”`.
- 

## **Contacts**

---

This feature provides “address-book” capabilities on your radio. Each entry corresponds to an alias (name) or ID (number) that you use to initiate a call.

Contact entries are alphabetically sorted according to entry alias. Each alias can have up to five IDs of different call types associated with it.

Additionally, each entry, depending on context (conventional, trunking, or phone), associates with one or more of the four types of calls: Phone Call, Selective Call, Private Call, or Call Alert.

Each entry within Contacts contains the following information:

- Call Alias (Name)
- Call ID (Number)
- Call Type (Icon)
- WACN ID (Astro 25 Trunking IDs only)
- System ID



### **Note**

Your radio must be preprogrammed to allow you to add, edit, or delete the contact entries.

Your radio also supports a maximum of 50 call lists. Each list can store up to 100 IDs (numbers).



#### Note

Your radio is preprogrammed with a number of contacts per Call Lists. Check with your dealer or system administrator for more information.

The radio automatically exits the feature, if the feature inactivity timer is enabled, when the radio is left idle and the timer expires. You hear the Menu Inactive Exit Tone upon feature exit.

### Making a Private Call from Contacts

Your radio must be preprogrammed to allow you to use this feature.

- 1 **◀** or **▶** to **Cnts** and press the **Menu Select** button directly below **Cnts**.

The entries are alphabetically sorted.

- 2 **▲** or **▼** to the required subscriber alias.
- 3 Press the **Menu Select** button directly below **Optn** and proceed to the next step.

- 4 **▲** or **▼** to **Call** and press the **Menu Select** button directly below **Se1**.

- 5 **▲** or **▼** to select the call type.

- 6 Hold the radio vertically 1 to 2 inches (2.5 to 5.0 cm) from your mouth.

- 7 Press the **PTT** button to initiate the call. During the call, the display shows the subscriber alias.

- 8 Press and hold the **PTT** button to talk. Release the **PTT** button to listen. The LED lights up solid red when the **PTT** button is pressed.

If there is no voice activity for a preprogrammed period of time, the call ends.

If the call reaches the maximum ring time, the call ends.

### Adding a Contact to a Call List

- 1 **◀** or **▶** to **Cnts** and press the **Menu Select** button directly below **Cnts**.

The entries are alphabetically sorted.

- 2 ▲ or ▼ to the entry you want to add and press the **Menu Select** button directly below Optn.
- 3 ▲ or ▼ to Add to CallLst and press the **Menu Select** button directly below Sel.
- 4 Perform one of the following actions:
  - ▲ or ▼ to the required Call List and press the **Menu Select** button directly below Add to add to the Call List.
  - ▲ or ▼ to Cncl to cancel and return to the main screen of Contacts.

The display shows momentary Please wait before showing <Entry> added to Call List, confirming the addition of the contact to the list.

The radio returns to the main display of **Contacts**.

### Removing a Contact from a Call List

- 1 ◀ or ▶ to Cnts and press the **Menu Select** button directly below Cnts.  
The entries are alphabetically sorted.

- 2 ▲ or ▼ to the entry you want to delete and press the **Menu Select** button directly below Optn.

- 3 ▲ or ▼ to Rm frm CallLst and press the **Menu Select** button directly below Sel.  
The display shows Remove <Entry> frm Call List?.

- 4 Press the **Menu Select** button directly below Yes to remove the entry from the Call List, or No to cancel and return to the main display of **Contacts**.  
The display shows momentary Please wait before showing <Entry> removed from Call List, confirming the removal of the contact from the list.

The radio returns to the main display of **Contacts**.

### Viewing Details of a Contact

- 1 ◀ or ▶ to Cnts and press the **Menu Select** button directly below Cnts.  
The entries are alphabetically sorted.
- 2 ▲ or ▼ to the entry you want to view and press the **Menu Select** button directly below Optn.

- 3 ▲ or ▼ to View and press the **Menu Select** button directly below Sel.
- 

The display shows all the numbers associated with the entry.

## Scan Lists

---

Scan lists are created and assigned to individual channels/ groups. Your radio scans for voice activity by cycling through the channel/group sequence specified in the scan list for the current channel/ group.

Your radio supports different types of Scan Lists:

- Trunking Priority Monitor Scan List
- Conventional Scan List
- Talkgroup Scan List

Please refer to a qualified radio technician for the maximum number of Scan Lists can be programmed in your radio. These lists must be preprogrammed by a qualified radio technician.

## Viewing a Scan List

- 1 ◀ or ▶ to ScnL and press the **Menu Select** button directly below ScnL.
  - 2 ▲ or ▼ to view the members on the list.
  - 3 Press  to exit the current display and return to the Home screen.
- 

## Editing the Scan List

This feature lets you change scan list members and priorities.

- 1 Perform one of the following actions:
  - Long press the preprogrammed **Scan List Programming** button (side button).
  - ◀ or ▶ to ScnL then press the **Menu Select** button directly below ScnL.

The display shows the lists that can be changed.

---

- 2 ▲ or ▼ to the entry you want to edit.
- 3 Perform one of the following actions:

- Press the **Menu Select** button directly below **Se1** to add and/or change the priority of the currently displayed channel in the scan list.
- Press the **Menu Select** button directly below **De1** to delete the currently displayed channel from the scan list.
- Press the **Menu Select** button directly below **Rc1** to view the next member of the scan list.

---

4 ▲ or ▼ to the desired channel then repeat step 3. Otherwise, proceed to the next step.

---

5 Perform one of the following actions:

- Move the **Scan List Programming** switch out of programming position.
- Press  to exit scan list programming and return to the Home screen.

---

See [Viewing and Changing the Priority Status](#) on page 74 for more information on how to add and/or change the priority of the currently displayed channel in the scan list.

## Changing the Scan List Status

1 Perform one of the following actions:

- Long press the preprogrammed **Scan List Programming** button (side button).
-  Move the preprogrammed **Scan List Programming** switch to programming position.

The display shows the programming mode icon and the first list member.

---

2 ▲ or ▼ to the member you want to edit.

---

3 Perform one of the following actions:

- Press the **Select** button once to add the currently displayed channel to the scan list.
  - Press the **Select** button one or more times to change the scan list status icon of the currently displayed channel.
- 

4 Perform one of the following actions:

- ▲ or ▼ to select more list members whose scan status you want to change.
-  Use the **MFK** knob to select another scan list member.

-  Use the **16-Position Select** knob to select another scan list member.

- 
- 5 Press  to exit scan list programming and return to the Home screen.
- 

## Viewing and Changing the Priority Status

Perform one of the following actions:

- Press the **Menu Select** button directly below  one or more times to change the priority status of the current displayed channel.
- Press the **Select** button one or more times to toggle between different status of the Scan List status icon of the current displayed channel.

The radio shows one of following priority status icons and scenarios:

- A Scan icon indicates that the current channel is in the scan list as a non-priority channel. The LED lights up solid green.
- A Priority-Two Channel Scan icon indicates that the current channel is in the scan list as the Priority-Two channel. The LED blinks green.

- A Priority-One Channel Scan icon indicates that the current channel is in the scan list as the Priority-One channel. The LED rapidly blinks green. You hear all traffic on the Priority-One channel, regardless of traffic on non-priority channels.
  - No icon indicates that the current channel is deleted from the scan list.
- 



## Scan

---

This feature allows you to monitor traffic on different channels by scanning a preprogrammed list of channels.

### Turning Scan On or Off

Perform one of the following actions:

- Press the preprogrammed **Scan** button to toggle **Scan On** or **Scan Off** to initiate or stop scan.
-  or  to **Scan** and press the **Menu Select** button directly below **Scan**.

If the scan is enabled, the display shows **Scan on** and the scan status icon.

If the scan is disabled, the display shows Scan Off.

---

The radio returns to the Home screen.

### Making a Dynamic Priority Change (Conventional Scan Only)

While the radio is scanning, the dynamic priority change feature allows you to temporarily change any channel in a scan list (except for the Priority-One channel) to the Priority-Two channel.

This change remains in effect until scan is turned off. Scan then reverts to the preprogrammed (original) setting.

Making a Dynamic Priority Change via the preprogrammed **Dynamic Priority** button:

- a) When the radio locks onto the channel designated as the new Priority-Two channel, press the preprogrammed **Dynamic Priority** button.  
The radio continues scanning the remaining channels in the list.
- 

### Deleting a Nuisance Channel

If a channel continually generates unwanted calls or noise (termed a “nuisance” channel), you can temporarily remove the unwanted channel from the scan list.

This capability does not apply to priority channels or the designated transmit channel.

When the radio is locked onto the channel to be deleted, perform one of the following actions:

- Press the preprogrammed **Nuisance Delete** button.
  - ◀ or ▶ to **Nuis** and press the **Menu Select** button directly below **Nuis**.
- 

The radio continues scanning the remaining channels in the list.

### Restoring a Nuisance Channel

To restore the deleted nuisance channel, perform one of the following actions:

- Stop and restart a scan.
- Mode change to another channel and back to the original channel.

- Turn off the radio and then turn it on again.

Nuisance mode delete can be disabled by the system administrator.

call received icons blinks and the display shows Page received.

Press any button to clear the Call Alert page.

See [Making a Talkgroup Call](#) on page 59 or [Making a Private Call \(Trunking Only\)](#) on page 60 for more information on returning the call.

## Call Alert Paging

This feature allows your radio to work like a pager.

Even if other users are away from their radios, or if they are unable to hear their radios, you can send them an individual Call Alert page. You can also verify if a radio is active on the system.

Depending on how your radio is programmed, when you make an Enhanced Private Call, the radio either automatically sends a call alert page if there is no answer after the maximum ring time, or when you press the **PTT** button.



### Note

This feature must be preprogrammed by a qualified radio technician.

## Sending a Call Alert Page

The following methods are options on how to send a call alert page. The result of all the methods is the same. You can use the options interchangeably depending on your preference and the programmed functions.



### Note

If the feature inactivity timer is enabled, your radio automatically exits the feature when your radio is left idle long enough for the time to expire. You hear the Menu Inactive Exit Tone upon feature exit.

- Sending a call alert page via the radio menu Page:
  - a) ◀ or ▶ to Page.
  - b) Press the **Menu Select** button directly below Page.

## Receiving a Call Alert Page

When you receive a Call Alert page, you hear four repeating alert tones and the LED blinks green. The



c) Press the **Menu Select** button directly below **Cnts** to view the required ID, ▲ or ▼ to the required ID.

d) Press the **PTT** button to send the page.

The display shows Paging...<Number>.

If the call alert page is sent successfully, you hear a tone and the display shows **Ack** received. The radio returns to the Home screen.

If the call alert page is not acknowledged, you hear a low tone and the display shows **No** acknowledge. Press the **Menu Select** button directly below **Ok** to return to the main screen of **Contacts**.

---

- Sending a call alert page via the radio menu **Call**:

a) ◀ or ▶ to **Call**.

b) Press the **Menu Select** button directly below **Call**.

c) ▲ or ▼ to select the alias or ID, and press the **PTT** button to initiate the call.

If the target radio does not respond after a preprogrammed period of time, the display shows **Send page?**.

d) To send the call alert page, press the **Menu Select** button directly below **Yes**. To exit the screen without sending the call alert page, press the **Menu Select** button directly below **No**.

The display shows Paging...<Alias>.

If the call alert page is sent successfully, you hear a tone and the display shows **Ack** received. The radio returns to the Home screen.

If the call alert page is not acknowledged, you hear a low tone and the display shows **No** acknowledge. Press the **Menu Select** button directly below **Ok** to return to the main screen of **Contacts**.

---

## Quick Call II (ASTRO P25 Digital Trunking and Conventional)

---

This feature allows the user to broadcast a series of distinct, recognizable tones before a voice transmission from the dispatcher or a radio.

The broadcasting dispatcher or radio user can select this alert tone transmission to be sent to an individual Talkgroup or over the entire system. Specific tone or

series of tones are pre-programmed into the radios to allow the dispatcher or supervisor to select a list of tones to broadcast before they make their voice transmission. Each tone is distinctive to indicate different situation or different broadcaster. The transmitting radio also plays back the tones for the broadcaster to listen.



#### Note

The receiving radios must be configured with the Quick Call II tone in order for the radio to sound the selected tone and also to sound a preconfigured alert tone after the selected tone has sound.

### Initiating a Quick Call II Transmission

The broadcasting or transmitting radio must be pre-programmed to see the tone in the Quick Call II tone list. The receiving radio must also be pre-programmed to decode the tone to broadcast.

- 1 ◀ or ▶ to **QCII**, and press the **Menu Select** button directly below **QCII**.
- 2 ▼ or ▲ to select the tone to broadcast.

- 3 Press the **PTT** to broadcast the selected tone, or press and hold the **PTT** to broadcast the selected tone and transmit with your vocal transmission. You hear the radio sounds the selected tone. You can begin your call after the tone ends.
- 4 Release **PTT** to listen.

### Emergency Operation

The Emergency feature is used to indicate a critical situation.

If the **Top (Orange)** button is preprogrammed to send an emergency signal, this signal overrides any other communication over the selected channel.

Your radio supports the following Emergency modes:

- Emergency Alarm
- Emergency Call (Trunking Only)
- Emergency Alarm with Emergency Call
- Silent Emergency Alarm

Check with your dealer or system administrator for more information on the programming of this feature.

Only **one** of the Emergency modes above can be assigned to the preprogrammed **Emergency** button.



#### Note

To exit emergency at any time, press and hold the preprogrammed Emergency button for about a second. This timer is programmable from 0 – 6250 milliseconds by a qualified technician.

The radio operates in the normal dispatch manner while in Emergency Call, except if enabled, it returns to one of the following:

#### Tactical/Non-Revert

The radio sends emergency alarm and/or make emergency call on the current selected channel.

#### Non-Tactical/Revert for Conventional system

The radio reverts to the preprogrammed emergency channel to send alarm and/or make emergency call.

#### Non-Tactical/Revert for

The radio reverts to the preprogrammed emergency talkgroup to

#### Trunking system

send alarm and/or make emergency call.

### Sending an Emergency Alarm

This feature allows you to send a data transmission, which identifies the radio sending the emergency, to the dispatcher.



#### Note

The default timer of Emergency button press to activate Emergency is 50 milliseconds. This timer is programmable from 50 – 6200 milliseconds by a qualified technician.

Press the preprogrammed **Emergency** button.

One of the following scenarios occurs:

- The display shows **Emergency** and the current zone or channel. You hear a short medium-pitched tone and the LED blinks red momentarily.
- The radio sounds a short low-pitched tone to indicate that the selected channel does not support emergency and rejects to launch emergency mode. The display shows **No**

emergency, if the selected channel does not support emergency.

---

When you receive the dispatcher's acknowledgment, the display shows `Ack received`. Four tones sound, the alarm ends, and the radio exits the Emergency Alarm mode.

If no acknowledgement is received, the display shows `No acknowledge`. The alarm ends when the timer expires and the radio exits the Emergency Alarm mode.

### **Sending an Emergency Call (Trunking Only)**

This feature gives your radio priority access to a talkgroup.

- 1 Press the preprogrammed **Emergency** button. One of the following scenarios occurs:
  - The display shows `Emergency` on the current zone and channel. You hear a short medium-pitched tone and the LED blinks red momentarily.
  - You hear the radio sounds a short low-pitched tone to indicate the selected channel does not

support emergency and rejects to launch emergency mode.

---

- 2 Hold the radio vertically 1 to 2 inches (2.5 to 5.0 cm) from your mouth.
  - 3 Press and hold the **PTT** button. Speak clearly into the microphone.
  - 4 Release the **PTT** button to end the transmission and wait for a response from the dispatcher.
  - 5 To exit Emergency Call, press and hold the preprogrammed **Emergency** button for about a second.
- 

### **Sending an Emergency Alarm with Emergency Call**

This feature gives your radio priority access on a channel for conventional system, and to a talkgroup for trunking system.

- 1 Press the preprogrammed **Emergency** button.  
  
If successful, the display shows `Emergency` on the current zone and channel. You hear a short, medium-pitched tone and the LED blinks red momentarily.

The radio exits Emergency Alarm and enters the Emergency Call state when one of the following scenarios occur:

- You receive the dispatcher acknowledgment. The display shows `Ack received`.
- You receive no acknowledgement. The display shows `No acknowledge`.
- You press the **PTT** button while in the Emergency Alarm mode.

If unsuccessful, you hear the radio sounds a short low-pitched tone to indicate the selected channel does not support emergency and rejects to launch emergency mode.

- 
- 2 Hold the radio vertically 1 to 2 inches (2.5 to 5.0 cm) from your mouth.
- 
- 3 Press and hold the **PTT** button. Speak clearly into the microphone.
- 
- 4 Release the **PTT** button to end the transmission and wait for a response from the dispatcher.
- 
- 5 To exit Emergency Call, press and hold the preprogrammed **Emergency** button for about a second.

Turning off the radio also cancels the emergency state.

---

### Sending a Silent Emergency Alarm

This feature allows you to send an Emergency Alarm to the system without triggering any audio or visual indicators.

- 1 Press the preprogrammed **Emergency** button. The display shows no changes, the LED does not light up, and you hear no tones. The silent emergency state continues until you perform the next step.
- 
- 2 Perform one of the following actions:
    - You press and hold the preprogrammed **Emergency** button for about a second to exit the Silent Emergency Alarm mode.
    - Press and release the **PTT** button to exit the Silent Emergency Alarm mode and enter regular dispatch or Emergency Call mode.

---

### Change of Channels during Emergency

For ALL Emergency transmissions, when changing channels:

- If the new channel is also preprogrammed for Emergency, you can change channels while in Emergency operation. The emergency alarm or call continues on the new channel.
- If the new channel is **not** preprogrammed for Emergency, the display shows *No emergency*, and you hear an invalid tone until you exit the Emergency state or change to a channel preprogrammed for Emergency.

### Emergency Keep-Alive Feature

This feature, when enabled, prevents the radio from being turned off via the **MFK** when the radio is in the Emergency state.



#### Note

The radio only exits the Emergency state using one of the ways mentioned in the previous sections.

See [Sending an Emergency Alarm](#) on page 79, [Sending an Emergency Call \(Trunking Only\)](#) on page 80, [Sending an Emergency Alarm with Emergency Call](#) on page 80, or [Sending a Silent Emergency Alarm](#) on page 81.

## Automatic Registration Service (ARS)

---

This feature provides an automated data application registration for the radio. When you turn on the radio, the device automatically registers with the server.

Data applications within the fixed network can determine the presence of a device on the system and send data to the device.

The Automatic Registration Service for the radio consists of two (2) modes:

- ARS Server Mode (default mode)
- ARS Non-Server Mode





#### Note





The default ARS mode can be changed by a qualified radio technician using the radio's programming software.

### Selecting or Changing the ARS Mode

The following methods are options on how to select or change the ARS Mode. The result of all the methods is the same. You can use the options interchangeably depending on your preference and the programmed functions.

- 
 Selecting or Changing the ARS mode via the **MFK**:
  - Once the zone you want is displayed, turn the preprogrammed **MFK** to the desired mode.

- 
 Selecting or Changing the ARS mode via **16-Position Select** knob:
  - Once the zone you want is displayed, turn the preprogrammed **16-Position Select** knob to the desired mode.

- Selecting or Changing the ARS mode via the radio menu:
  -  or  to Chan.
  - Press the **Menu Select** button directly below Chan.  
The display shows the current channel name.
  -  or  to the required channel or mode.  
One of the following scenarios occur:
    - In ARS Server Mode, the display shows the zone and ARS server channel.

- In ARS Non-Server Mode, the display shows the zone and ARS non-server channel.
  - If the channel or mode selected is unprogrammed, the display shows Unprogrammed. Repeat this step.
- Press **Set** to confirm the displayed channel.

## User Login Feature

This feature allows you as the user to be associated with the radio. With this association, every data application (Example: Text Messaging Service) takes on a friendly username.

You can still send text messages without logging in as a user. The user login feature only enables the recipient of your message to identify you as the sender by assigning a username to your message.



### Note

A predefined username that is set more than the maximum allowed characters is an invalid name.

## Logging In as a User

- Perform one of the following actions:

- Press the preprogrammed **User Login** button.
- ◀ or ▶ to **User** and press the **Menu Select** button directly below **User**.

The display shows the User Login screen.

## 2 Perform one of the following actions:

- ▲ or ▼ to scroll through the list of predefined user names. Press the **Menu Select** button directly below **Login** to select the predefined username.
- Press and hold ▲ or ▼ to scroll through the list of predefined user names at a fast scroll rate. Press the **Menu Select** button directly below **Login** to select the predefined user name.

One of the following scenarios occurs:

- If the ID is invalid, the display shows momentary **Invalid ID**.
- In ARS Server Mode, the display shows the User Login Indicator icon, the ID, and **In progress, with Cncl**.
- In ARS Non-Server Mode, the display shows the User Login Indicator icon, the ID, and **Logged in, with Logt and Exit**.

- In non-ARS enabled mode, the display shows **Offline, with Logt and Exit**.

One of the following scenarios occurs:

- If the user name is invalid, login fails and the user login failure indicator (IP indicator) icon blinks. The display also shows momentary **Login failed**.
- Wait for the logged in confirmation screen. If the login process is successful, the display shows the successful user login indicator (IP indicator) icon and **Logged in, with Logt and Exit**.



### Note

To cancel the login process and return to the initial user login screen, press the **Menu Select** button directly below **Cncl**.

## Logging Out

When you have logged in or you are using Offline mode, you can log out.



### Note

Private data refers to all messages in the text messaging **Inbox**, **Draft**, and **Sent** folder. The next user is able to access the **Inbox**, **Draft** and **Sent** messages if private data is not deleted.



- 1 Press the **Menu Select** button directly below Logt.

One of the following scenarios will occur:

- The display shows `Clear private data?`. Proceed to the next step.
- If the Delete Messages On Session End feature is enabled, the radio clears the private data and returns to **User Login** screen.

- 
- 2 Perform one of the following actions:

- Select **Yes** to clear all your private data. The display shows momentary `Private data cleared`.
  - Select **No** to keep your private data.
- 

## Text Messaging Service (TMS)

This features allows you to quickly send and receive messages and run database queries directly from your radios. The maximum length of characters for a text message is 200.

The types of text messages available:

- A predefined message (quick text message).

- An edited quick text message.

The main menu consists of the following options:

- Inbox
- Compose
- Sent



### Note

See [Status Icons](#) on page 41 for more information on the TMS icons and [TMS Menu Options](#) on page 44 for more information on each menu option.

## Sending a Quick Text Message



Quick Text messages are messages that are predefined and usually consist of messages that are used most frequently.

Each Quick Text message has a maximum length of 50 characters. You can select the required text from the Quick Text.

- 1 Perform one of the following actions:
  - To access this feature via a preprogrammed button, press the preprogrammed **Quick Text** button and proceed to Step 4.



- To access this feature via the menu, proceed to the next step.

---



2  or  to TMS and press the **Menu Select** button directly below TMS to access the TMS feature screen.

---



3 Perform one of the following actions:

-  or  to Compose and press the **Menu Select** button directly below Sel.
- Press the **Menu Select** button directly below Exit to return to the Home screen.

---

4  or  to Quick Text and press the **Menu Select** button directly below Sel for a predefined message.



---

5  or  to scroll through the list of messages and press the **Menu Select** button directly below Sel to select the required message.  
The message appears on the Compose screen, with a blinking cursor at the end of it.

---





6 Press the **Menu Select** button directly below Optn.

---

7  or  to Send Message and press the **Menu Select** button directly below Sel.

---

8 Perform one of the following actions:

-  or  to scroll through the address list and highlight the required address.
-  or  to [Other Recpnt] and press the **Menu Select** button below Edit. When a blinking cursor appears on the Enter Address screen.

---

9 Press the **Menu Select** button directly below Send or press the PTT button to send the message.

The display shows the Send Message screen and Sending msg.

If the message is sent, you hear a tone and the display shows Msg sent.

If the message is not sent, you hear a low tone, the display shows Send failed and returns to the main TMS screen.



**Note**

You can append a priority status and/or a request reply to your message. See [Priority Status and Request Reply of a New Text](#)

[Message](#) on page 87 for more information.

---

## Priority Status and Request Reply of a New Text Message

Before sending your message, you can append a priority status and/or a request reply to your message.

### *Appending a Priority Status to a Text Message*



#### Note

The Priority Status icon on a message does not imply that the message gets higher priority over the other messages when it is being transmitted. It is just an indication that can be embedded into a message to let the receiver know that the message is important.

- 1 Press the **Menu Select** button directly below Optn.

---

- 2 ▲ or ▼ to Mark Important and press the **Menu Select** button directly below Sel to indicate the message is important.

The priority status icon appears beside the normal message icon on the label bar.

### *Removing a Priority Status from a Text Message*

- 1 Press the **Menu Select** button directly below Optn.

---

- 2 ▲ or ▼ to Mark as Normal and press the **Menu Select** button directly below Sel to remove the priority status from the message.

The display shows the normal message icon on the label bar.

### *Appending a Request Reply to a Text Message*

- 1 Press the **Menu Select** button directly below Optn.

---

- 2 ▲ or ▼ to Req Reply and press the **Menu Select** button directly below Sel to request for a reply.

The request reply icon appears beside the normal message icon on the label bar.

### *Removing a Request Reply from a Text Message*

- 1 Press the **Menu Select** button directly below Optn.

- 2 ▲ or ▼ to No Req Reply and press the **Menu Select** button directly below Sel to remove the priority status from the message.

---

The display shows the normal message icon on the label bar.

### ***Appending a Priority Status and a Reply Request to a Text Message***

- 1 Press the **Menu Select** button directly below Optn.
- 2 ▲ or ▼ to Mark Important and press the **Menu Select** button directly below Sel to indicate the message is important.
- 3 ▲ or ▼ to Req Reply and press the **Menu Select** button directly below Sel to request for a reply.

---

The priority status and request reply icons appear beside the normal message icon on the label bar.

### ***Removing a Priority Status and a Reply Request from a Text Message***

- 1 Press the **Menu Select** button directly below Optn.

- 2 ▲ or ▼ to Mark Important and press the **Menu Select** button directly below Sel to remove the priority status icon.

- 3 ▲ or ▼ to No Req Reply and press the **Menu Select** button directly below Sel to remove the reply status icon.

---

The display shows the normal message icon on the label bar.

### ***Receiving a Text Message***



#### **Note**

When you receive a message that is flagged with the “Request Reply” icon, you must manually respond to the sender that you have received the message. The system will not automatically send back a notification that the radio has received such message.

The following methods are options on how to receive a text message. The result of all the methods is the same. You can use the options interchangeably depending on your preference and the programmed functions.

- Receiving a text message via the **Data Feature** button or the **TMS Feature** button:

- a) When you receive a message, press and hold the preprogrammed **Data Feature** button or the **TMS Feature** button to access the Inbox. The display shows a list of aliases or IDs, with the sender of the latest received message on top.

- 
- Receiving a text message via the radio menu:
    - a) When the new message icon appears and the display shows momentary *New msg*, press the **Menu Select** button directly below **TMS** to access the Inbox. The display shows a list of aliases or IDs, with the sender of the latest received message on top.

---

### Viewing a Text Message from the Inbox

The Inbox can hold up to thirty (30) messages.



#### Note

▲ or ▼ to read the message if the content fills more than one screen.

- 1 Perform one of the following actions:
  - Press the preprogrammed **Data Feature** button or the **TMS Feature** button to access the TMS

feature screen. ▲ or ▼ to **Inbox** and press the **Menu Select** button below **Sel**.

- Press and hold the preprogrammed **Data Feature** button or the **TMS Feature** button to access the Inbox.
- ◀ or ▶ to **TMS** and press the **Menu Select** button directly below **TMS** to access the TMS feature screen. ▲ or ▼ to **Inbox** and press the **Menu Select** button below **Sel**.

The display shows a list of aliases or IDs, with the sender of the latest received message on top.

- 
- 2 ▲ or ▼ to the required aliases or ID and press the **Menu Select** button below **Sel** to view the message.

While on the view message screen, press the **Menu Select** button directly below **Rply**, **Del**, or **Back** to access the option.

- Select **Rply** to reply the message.
- Select **Del** to delete the message.
- Select **Back** to return to the previous screen.



#### Note

The icon at the top right corner of the screen indicates the status of the message.

See [Text Messaging Service \(TMS\) Indicators](#) on page 43 for more information.

---

### Replying to a Received Text Message



#### Note

The original date and time stamp, address and message content is automatically appended to the reply message.

- 1 ▲ or ▼ to the required aliases or ID and press the **Menu Select** button below `Sel` to view the message.

---

  - 2 Press the **Menu Select** button directly below `Rply` to reply to a message.  
The display shows a list of `Quick Text`.

---

  - 3 Press the **Menu Select** button directly below `Optn` once you have completed the message.

---

  - 4 ▲ or ▼ to `Send Message` and press the **Menu Select** button directly below `Sel` to send the message.
- 

The display shows the `Send Message` screen and `Sending msg.`



#### Note

Press the **Menu Select** button directly below `Back` at any time to return to the previous screen.

You can append a priority status and/or a request reply to your message. See [Priority Status and Request Reply of a New Text Message](#) on page 87 for more information.

### Sent Text Messages

Once a message is sent to another radio, it is saved in the Sent folder. The most recent sent text message is always added to the top of the Sent list.

The Sent folder is capable of storing a maximum of ten (10) last sent messages. When the folder is full, the oldest message in the folder is deleted when the 11th message comes in.

### Viewing a Sent Text Message

- 1 Perform one of the following actions:
  - Press the preprogrammed **Data Feature** button or the **TMS Feature** button to access the TMS feature screen.

- ▲ or ▼ to TMS and press the **Menu Select** button directly below TMS to access the TMS feature screen.

- 
- 2 ▲ or ▼ to Sent and press the **Menu Select** button below Sel.  
The display shows a list of aliases or IDs, with the recipient of latest sent message on top.

- 
- 3 ▲ or ▼ to the required aliases or ID and press the **Menu Select** button below Sel to view the message.

While on the view message screen, press the **Menu Select** button directly below Optn, Del or Back to access the option.

- Select Optn to configure the message settings.
- Select Del to delete the message.
- Select Back to return to the previous screen.



#### Note

The icon at the top right corner of the screen indicates the status of the message. See [Text Messaging Service \(TMS\) Indicators](#) on page 43 for more information.

## Sending a Sent Text Message

- 1 Press the **Menu Select** button directly below Optn while viewing the message.
- 
- 2 ▲ or ▼ to Send Message and press the **Menu Select** button directly below Sel.
- 
- 3 ▲ or ▼ to scroll through the address list and highlight the required address.
- 
- 4 Press the **Menu Select** button below Send or the **PTT** button to send the message.



#### Note

Press the **Menu Select** button directly below Back at any time to return to the previous screen.

You can append a priority status and/or a request reply to your message. See [Priority Status and Request Reply of a New Text Message](#) on page 87 for more information.

## Deleting a Text Message

- 1 From the **Inbox** or **Sent** screen, ▲ or ▼ to scroll through the messages.

- 2 Press the **Menu Select** button directly below **Del** to delete the current message.

---

### ***Deleting All Text Messages***

- 1 Perform one of the following actions:
    - Press the **Data Feature** button or the preprogrammed **TMS Feature** button to access the Messaging feature screen.
    - ◀ or ▶ to **TMS** and press the **Menu Select** button directly below **TMS** to access the **TMS** feature screen.
- 
- 2 ▲ or ▼ to **Inbox** or **Sent** then press the **Menu Select** button below **Clr** to select all messages in the selected folder.  
The display shows **Del All?**.
- 
- 3 Perform one of the following actions:
    - Press the **Menu Select** button directly below **Yes** to delete all the messages in the selected folder.
    - Press the **Menu Select** button directly below **No** to return to the main **TMS** feature screen.
- 

## **Global Positioning System / Global Navigation Satellite System**

---

The Global Navigation Satellite System (GNSS) in the radio uses information from the Global Positioning System (GPS) to determine the approximate geographical location of your radio. The geographical location is expressed as latitude and longitude or Military Grid Reference System (MGRS) format per request from customers.



### **Note**

This feature is addressed as GPS across the manual as the naming convention of the buttons and strings remain the same as the legacy feature of GPS.

The availability and accuracy of this location information (and the amount of time that it takes to calculate it) varies depending on the environment in which you are using the GPS feature.

For example, GPS location fixes are difficult to obtain indoors, in covered locations, between high buildings, or in situations where you have not established a clear broad view of the sky.



Once GPS is enabled, the radio displays the GPS icon on the screen. The dispatcher can always request the system to determine the real-time location coordinates of the radio.

## GPS Operation

The GPS technology uses radio signals from earth orbiting satellites, to establish the location coordinates, maximizing your view of clear unobstructed sky is essential for optimum performance.

Where adequate signals from multiple satellites are not available (usually because you cannot establish a view of a wide area of the sky), the GPS feature of your radio will not work. Such situations include but are not limited to:

- Underground locations
- Inside of buildings, trains, or other covered vehicles
- Under any other metal or concrete roof or structure
- Between tall buildings or under dense tree-cover
- In temperature extremes outside the operating limits of your radio

Even where location information can be calculated in such situations, it may take longer to do so, and your location estimate may not be as accurate. Therefore, in any emergency situation, always report your location to your dispatcher.

Keep in mind that the accuracy of the location information and the time it takes to obtain it varies depending upon circumstances, particularly the ability to receive signals from an adequate number of satellites.



### Note

Even where adequate signals from multiple satellites are available, your GPS feature only provides an approximate location, usually within 10 meters from your actual location, but sometimes farther away.

The satellites used by the GPS feature are controlled by the U.S. government and are subject to changes implemented in accordance with the Department of Defense GPS user policy and the Federal Radio Navigation Plan. These changes may affect the performance of the GPS feature on your radio.

## GPS Performance Enhancement

Sometimes, the GPS feature may be unable to complete a location calculation successfully. You then see a message indicating that your radio cannot connect to enough visible satellites.

To maximize the ability of your radio to determine a fix, take note of the following guidelines:

- For your initial fix, hold the radio in the face position.
- Stay in the open. The GPS feature works best where there is nothing between your radio and a large amount of open sky.

## The Outdoor Location Feature (Using GPS)

This feature allows you to determine your current location using a location menu, as well as your current distance and bearing in relation to another location. Radio location may be requested and reported over-the-air.

Your radio stores up to a maximum of sixty (60) programmable location coordinates, also known as waypoints. When the memory is full, the next waypoints automatically replaces the oldest waypoints in the radio.

The radio also stores four (4) preprogrammed waypoints. These coordinates cannot be deleted.

The following table shows the differences between programmable waypoints and preprogrammed waypoints.

Programmable Waypoints	Preprogrammed Waypoints
User-configurable location coordinates.	Fixed location coordinates: <ul style="list-style-type: none"><li>• Home</li><li>• Emergency</li><li>• Last Known Location</li><li>• Destination</li></ul>



### Note

The radio automatically exits the feature, if the feature inactivity timer is enabled, when the radio is left idle and the timer expires. You hear the Menu Inactive Exit Tone upon feature exit.

## Military Grid Reference System (MGRS) Coordinates

This feature can only be enabled through CPS configuration. When the MGRS coordinate is enabled, all location coordinates are displayed in MGRS format, including the editable locations in GPS.



### Accessing the Outdoor Location Feature



#### Note

An **ON** radio menu may be present on the Location menu screen if it is preprogrammed by the dealer or system administrator.

Press the preprogrammed **GPS** button to toggle the Outdoor Location feature to on or follow the following procedure to access this feature via the radio menu.



- 1  or  to `Loc.`

---

- 2 Press the **Menu Select** button directly below `Loc.`  
The display shows `Location off.`

---

- 3 Perform one of the following actions:
  - To obtain a location fix, press the **Menu Select** button directly below `On`.

- Press the **Menu Select** button directly below `Optn.`  or  to Turn On GPS and press the **Menu Select** button directly below `Sel.`

The front display shows the MGRS or latitude/longitude location, time, and date of the last successful location fix.







- 4 To obtain a new location fix, press the **Menu Select** button directly below `Rfsh.`  
The top line temporarily displays `Please wait` while the new location is being determined. While the new location is being determined, the location signal can be a solid or blinking icon.  
  
Once the location coordinates are fixed, the display shows the current location along with the UTC (Zulu) time and date that the location fix was obtained.  
  
The location coordinates are updated automatically every 5 seconds while the location signal is present.  
  
If the radio fails to get a location fix, the display shows `No service` and returns to the previous display.

- 5 To return to the **Home** screen, press , the **PTT** button, the preprogrammed **GPS** button or the **Menu Select** button directly below **Exit**.

---

## Saving a Waypoint

Ensure that your radio shows the current location on the screen.

- 1 Press the **Menu Select** button directly below **Optn.**
- 2 Perform one of the following actions:
  -  or  to **Save as Waypt** and press the **Menu Select** button directly below **Sel.**
  -  or  to **Save as Home** and press the **Menu Select** button directly below **Sel** and proceed to step 5.
  -  or  to **Save as Dest.** and press the **Menu Select** button directly below **Sel** and proceed to step 5.

- 3 Press the **Menu Select** button directly below **Ok** once you are done.  
One of the following scenarios occur:





- The display shows **Current loc saved as <Waypoint name>**.
- The display shows **Current loc saved as [Home]**.
- The display shows **Current loc saved as [Destination]**.

- 
- 4 To return to the Home screen, press , the **PTT** button, the preprogrammed **GPS** button or the **Menu Select** button directly below **Exit**.

---

## Viewing a Saved Waypoint

Ensure your radio shows the current location on the screen.

- 1 Press the **Menu Select** button directly below **Optn.**
- 2  or  to **Waypoints** and press the **Menu Select** button directly below **Sel.**  
The display shows a list of waypoints.
- 3 Perform one of the following actions:
  -  or  to scroll through the list.

- ▲ or ▼ to select a waypoint to view the location information in full.

---

4 Press the **Menu Select** button directly below `Optn.`

---

5 To view the MGRS or latitude/longitude location, time and date of the selected waypoint, ▲ or ▼ to `View` and press the **Menu Select** button directly below `Sel.`

---

6 To return to the previous screen, press the **Menu Select** button directly below `Back`, or to return to the Home screen, press , the **PTT** button, or the preprogrammed **GPS** button.

---

### Deleting a Single Saved Waypoint

Ensure your radio shows the current location on the screen.

1 Press the **Menu Select** button directly below `Optn.`

---

2 ▲ or ▼ to `Waypoints` and press the **Menu Select** button directly below `Sel.`  
The display shows a list of waypoints.

---

3 Perform one of the following actions:

- ▲ or ▼ to `Edit name` and press the **Menu Select** button directly below `Del.`
  - Press the **Menu Select** button directly below `Del.`
- 

4 The display shows `Delete <Waypoint name> Confirm?`

---

5 Press the **Menu Select** button directly below `Yes` to delete the waypoint or press the **Menu Select** button directly below `No` to return to the Waypoints main screen.

---

The display shows `<Waypoint name>deleted.`

### Deleting All Saved Waypoints

Ensure your radio shows the current location on the screen.



#### Note

You cannot delete any of the preprogrammed waypoints.

1 Press the **Menu Select** button directly below `Optn.`

---

2 ▲ or ▼ to Waypoints and press the **Menu Select** button directly below Sel.  
The display shows a list of waypoints.

---

3 ▲ or ▼ to the required saved waypoint, and press the **Menu Select** button directly below Optn.

---

4 ▲ or ▼ to Delete All and press the **Menu Select** button directly below Sel.  
The display shows Delete All saved waypnts Confirm?.

---

5 Press the **Menu Select** button directly below Yes to delete all waypoints or press the **Menu Select** button directly below No to return to the Waypoints main screen.

---

The display shows All saved waypnts deleted.

### Measuring the Distance and Bearing from a Saved Waypoint

Ensure your radio shows the current location on the screen.

1 Press the **Menu Select** button directly below Optn.

---

2 ▲ or ▼ to Dist frm here and press the **Menu Select** button directly below Sel.  
The display shows a list of waypoints.

---

3 ▲ or ▼ to the required waypoint and press the **Menu Select** button directly below Sel.

---

The display shows the distance and bearing from the current to the selected coordinates.

### Location Feature in Emergency Mode

When the Emergency feature is activated by pressing the emergency button, the radio exits the Location menu and returns to the Home (default) screen so that you can see which channel the emergency signal is going out on.

However, you may re-enter the Location menu while still in emergency mode, provided that Silent Emergency has not been activated.

If you have turned Location off using the **ON/OFF** menu key, it automatically turns back on when Emergency is activated.

If there is a solid location signal during Emergency, the current location and the location information

received is saved as Emergency and Last Known Location waypoints, respectively.

### Peer-Location on the Display (ASTRO Conventional only)

This feature is only available for radio-to-radio voice transmissions, dispatch call and selective call in conventional ASTRO system. For radio-to-radio transmission, in order to allow the radio to show peer-location, the voice should be directly sent from one radio to another radio without passing through any infrastructure facility such as repeaters, phone or DVRS system. Both the transmitting radio and receiving radio must be configured to enable them to send and/or receive the GPS coordinates. You can check with your nearest qualified technician for more details.



#### Note

If the receiving radio is operating in a Mixed Mode channel, only if its voice transmission is via conventional ASTRO system then it can receive the location coordinates of its peers.

This feature is also operable in a Scan Active channel or Scan Talkback channel.

Upon receiving a voice transmission with GPS coordinates enabled on the receiving radio, the display shows the coordinates available in full or in short coordinates. There are two different formats available. Refer to the following list for the details shown in the Peer-Location quick text. Consult your agent to pick the best format to configure to your radio.

#### Full location coordinates

- PTT ID (This is optional.)
- Longitude and latitude
- Relative distance or direction.

#### Short location coordinates

- PTT ID (This is optional.)
- Longitude and latitude



#### Note

If the transmitting radio is stale at its location after a period of time, the receiving radio display shows ID:<PTT ID> Last Known Loc: <Coordinates>. The ID:<PTT ID> and <distance> are optional details depending on the requirements of usage.

If the transmitting radio does not have GPS or the receiving radio could not decode the GPS signal of the received signal, the receiving radio display shows `ID:<PTT ID> Unknown Loc.` The PTT ID is optional to be shown on the display per requirements of usage.

Any new text messages received at Geofence shall have its content displayed immediately on the radio display.



#### Note

If the radio is set up in DVRS, only mobile radio is supported for this feature.

## Geofence (ASTRO 25 Trunking System)

Geofence is a virtual perimeter based on the GPS to define a geographical area on earth.

When the radio enters the predefined Geofence area, your radio receives the Dynamic Regroup command from the system and immediately connects to a Dynamic Regroup talkgroup. The radio display shows the new selected Dynamic Regrouped talkgroup with green intelligent light for your attention.

On top of that, additional features are Voice Announcement of the new channel, and also direct content display of a text message to indicate that you are currently at Geofence area. Check with your nearest qualified technician on the requirements for these enhancements to work in Geofence.

## Entering the Geofence Area

The Voice Announcement and TMS display in this feature are optional. They must be configured to enable you to hear and see these indicators.

When the radio enters a Geofence area, the radio immediately sends a message `ACK` back to the system.

The radio searches the current zone for the channel with same talkgroup assigned as the Dynamic Talkgroup and also with same system ID of current trunk system. Once matched, the radio display shows the first matched and connected channel alias.

If there is no channel with matched Talkgroup ID and trunk system ID, the radio display shows the channel alias of `<DYNAMIC talkgroup>`.

Once the radio is connected, you hear a dynamic regroup tone, the radio display shows `<DYNAMIC`



channel > with temporary green color intelligent backlight and you hear a Voice Announcement.



#### Note

When the radio loses the GPS signal the GPS icon blinks and the radio sounds two high-pitched tones repetitively to indicate GPS fails to operate. The radio display shows red intelligent light.



#### Note

If the first matched channel is not configured with Voice Announcement, no Voice Announcement is played.

The system sends a message to your radio. The radio display shows a direct text message content without any user operation. This message indicates you are currently present in a Geofence area. This TMS remains open on the display until user presses exit/home to exit this screen.



#### Note

If there is another incoming text message before you exit the previous message, the message screen shall be refreshed to show the latest message.

The following procedure guides you to exit the text message received.

Press the **Menu Select** button below Exit or  to return to **Home** screen.

The other operations are the same as normal dynamic regroup command.

When the radio exits the Geofence area, your radio reverts to original channel or newly assigned talkgroup. The radio display shows the new channel together with Voice Announcement to indicate the changes. Voice Announcement of the new channel only works if that channel is configured with Voice Announcement.

## Trunking System Controls

### Operating in Failsoft System

The failsoft system ensures continuous radio communications during a trunked system failure. If a trunking system fails completely, the radio goes into failsoft operation and automatically switches to its failsoft channel.

During failsoft operation, your radio transmits and receives in conventional operation on a

predetermined frequency. You hear a medium-pitched tone and the display shows `Failsoft`.

When the trunking system returns to normal operation, your radio automatically leaves failsoft operation and returns to trunked operation.

To continue, in Failsoft, to communicate with other talkgroups, refer to the following procedure.

- 1 Rotate the **Mode Knob** to change to a different repeater frequency.
- 2 Press the **PTT** button to talk, and release the button to listen.

### Out-of-Range Radio

When your radio goes out of the range of the system, it can no longer lock onto a control channel.

You hear a low-pitched tone and/or the display shows the currently selected zone/channel combination and `Out of range`. Your radio remains in this out-of-range condition until it locks onto a control channel, it locks onto a failsoft channel, or it is turned off.

### Site Trunking Feature

If the zone controller loses communication with any site, that site reverts to site trunking.

The display shows the currently selected zone/channel combination and `Site trunking`.



#### Note

When this occurs, you can communicate only with other radios within your trunking site.

### Locking and Unlocking a Site

This feature allows your radio to lock onto a specific site and not roam among wide-area talkgroup sites. This feature should be used with caution, since it inhibits roaming to another site in a wide-area system.

You can toggle the lock state between locked and unlocked by pressing the preprogrammed **Site Lock/Unlock** button.

Follow the following procedure to lock and unlock a site via the radio menu.

- 1  or  to `Site`.

- 2 Press the **Menu Select** button directly below **Site**.
- 

- 3 Perform one of the following actions:

- To lock the site, press the **Menu Select** button directly below **Lock**. The display shows **Site locked**.
  - To unlock the site, press the **Menu Select** button directly below **Unlk**. The display shows **Site unlocked**.
- 

The radio saves the new site lock state and returns to the Home screen.

### Site Display and Search Button

The **Site Display** and **Site Search** button allows you to view the name of the current site or force your radio to change to a new one.

#### Viewing the Current Site

Perform one of the following actions:

- Press the preprogrammed **Site Displ/Srch** button.

- **◀** or **▶** to **RSSI** and press the **Menu Select** button directly below **RSSI**.
- 

The display shows momentarily the name of the current site and its corresponding received signal strength indicator (RSSI).

#### Changing the Current Site

Perform one of the following actions:

- Press and hold down the preprogrammed **Site Displ/Srch** button.
- Press and hold down the **Menu Select** button directly below **RSSI**.

You hear a tone and the display shows momentarily **Scanning site**.

---

When the radio finds a new site, it returns to the Home screen.

### Over-the-Air Programming (POP 25, ASTRO 25, ASTRO Conventional)

---

This feature enables configuration data and firmware to be upgraded to your radio over-the-air. Full use of the radio is retained during the data transfer without interrupting communication. For ASTRO 25 and

ASTRO Conventional, the upgrade pauses to give priorities to voice call, and continues after the voice call ended. For Wi-Fi®, the upgrade process runs concurrently with voice calls.

Once a configuration upgrade is downloaded to your radio, you can install new changes immediately or delay changes to be installed on the radio when it is being powered up.

Your radio can also be configured to allow you to accept or reject an upgrade.



#### Note

This feature must be preprogrammed by a qualified radio technician. Check with your dealer or system administrator for more information.

### Responding to the Notification of Upgrade

- 1 The display shows `Upgrade?` and two short, medium- pitched tones sounds every 30 seconds until the user makes a choice of accepting, delaying, or rejecting the request
- 
- 2 Perform one of the following actions:

- Press the **Menu Select** button below `Acpt` to accept the request to upgrade immediately.
- Press the **Menu Select** button below `Delay` to delay the request to upgrade.
- Press the **Menu Select** button below `Rej` to reject the request to upgrade.

---

One of the following scenarios occurs:

- If you choose to accept, the display shows `Programming Dont power off` to indicate the upgrade is about to begin. The radio resets to install the upgrade. In the case of configuration data upgrade, this process only takes a few seconds. In the case of firmware upgrade, the installation takes several minutes.



#### Note

The radio cannot be used while the upgrade is being installed. Therefore, make sure to only accept the upgrade at a convenient time when immediate radio use is not required.

- If you choose to delay, a configuration data upgrade is installed automatically at the next power up. However, in the case of a firmware

upgrade, the radio prompts Upgrade? again at the next power up.

- If you choose to reject, the display shows Upgrade Aborted. The radio continues to function with the current configuration until it gets reprogrammed.



#### Note

If your radio has problems upgrading over-the-air, consult a qualified technician for details.

## Voice Announcement

---

This feature enables the radio to audibly indicate the current feature mode, zone or channel the user has just assigned. This audio indicator can be customized per customer requirements. This is typically useful when the user is in a difficult condition to read the content shown on the display.

Each voice announcement is within a limit of three seconds maximum. The sum duration of all different voice announcements in a radio shall be no more than 1000 seconds.



#### Note

This feature must be preprogrammed by a qualified radio technician.

Check with your agent if Voice Announcement is available for the feature you need.

The two options of priority for the Voice Announcement available are:

- High** Enables the voice of the feature to announce even when the radio is receiving calls.
- Low** Disables the voice of the feature from announcing when the radio is receiving calls.

You hear a voice announcement when the features below are preprogrammed in the radio.

- The radio powers up. The radio announces the current zone and channel it is transmitting.
- Press the preprogrammed voice announcement button (which specifically programmed to playback the current zone and channel). The radio announces the current zone and channel it is transmitting.



#### Note

Pressing this preprogrammed playback button enables the voice feature to announce in High priority.

All the three programmable buttons at the side of the radio support this feature.

- Change to a new zone. The radio announces the current zone and channel it is transmitting.
- Change to a new channel remaining within the current zone. The radio announces the current channel.
- Press either the **Menu Select** button or preprogrammed button of the radio to launch or terminate Scan, PL Disabled, Talkaround/Direct or Transmit Inhibit. The radio announces the corresponding feature activation or deactivation.

## Utilities

---

### Viewing Recent Calls

This feature allows you to view the recent incoming and outgoing call information of the following call types:

- Call Alert
- Selective Call
- Private Call
- Phone Call (Outgoing Only)
- Emergency Call (Incoming Only)



### Note

The radio can also be preprogrammed to log only the radio IDs associated with incoming Dispatch Calls. Check with your dealer or system administrator for more information.

The following methods are options on how to view recent calls. The result of all the methods is the same. You can use the options interchangeably depending on your preference and the programmed functions.

- Viewing recent calls via the preprogrammed **Recent Calls** button:
  - a) Press the preprogrammed **Recent Calls** button.
  - b) ▲ or ▼ to scroll through the list.
  - c) To return to the Home screen, press the **Menu Select** button directly below **Exit**, press  or the **PTT** button.

---

- Viewing recent calls via the radio menu:
  - a) ◀ or ▶ to **Recent**.
  - b) Press the **Menu Select** button directly below **Recent** to access the **Recent Calls** feature screen.
  - c) ▲ or ▼ to scroll through the list.

- d) To return to the Home screen, press the **Menu Select** button directly below **Exit**,  or the **PTT** button.

The radio automatically exits the feature, if the feature inactivity timer is enabled, when the radio is left idle and the timer expires. You will hear the Menu Inactive Exit Tone upon feature exit.

### Selecting the Power Level





#### Note

This feature must be preprogrammed by a qualified radio technician.

This feature enables you to reduce the transmit power level for specific case that requires a lower power level. You can select the power level at which your radio transmits. The radio always turns on to the default setting. These reduced transmit power level settings do not affect the receiving performance of your radio, nor diminish the overall quality of the audio and data functionality of the radio given the following conditions.

Power level **Low** enables a shorter transmitting distance and to conserve power. Power level **High** enables a longer transmitting distance.

The following methods are options on how to select the power level. The result of all the methods is the same. You can use the options interchangeably depending on your preference and the programmed functions.

- Selecting the Power Level via the **Transmit Power Level** switch:
  - a) Use the preprogrammed **Transmit Power Level** switch to toggle the power level between low and high power.
- Selecting the Power Level via the radio menu:
  - a)  or  to **Pwr.**
  - b) Press the **Menu Select** button directly below **Pwr.**

The display shows **Low power** and the low power icon or the display shows **High power** and the high power icon.

### Selecting a Radio Profile

This feature allows you to manually switch the visual and audio settings of the radio. The display, backlight, alert tones, and audio settings are defined according

to the preprogrammed radio settings of each radio profile.

Please refer to a qualified technician for more information.



#### Note

The radio automatically exits the feature, if the feature inactivity timer is enabled, when the radio is left idle and the timer expires. You will hear the Menu Inactive Exit Tone upon feature exit.

The following methods are options on how to select a radio profile. The result of all the methods is the same. You can use the options interchangeably depending on your preference and the programmed functions.

- Selecting a radio profile via the preprogrammed **Profile** button:
  - a) Press the preprogrammed **Profile** button.
  - b) ▲ or ▼ to scroll through the menu selections.
  - c) Press the **Menu Select** button directly below **Sel** to select the required radio profile, or press the **Menu Select** button directly below **Exit** to exit the screen without making any changes.

The radio returns to the Home screen. The profile name on the Home screen indicates the current selected radio profile.

---

- Selecting a radio profile via the radio menu:
  - a) ◀ or ▶ to **Prfl** and press the **Menu Select** button directly below **Prfl** to access the **Profiles** feature screen.
  - b) ▲ or ▼ to scroll through the menu selections.
  - c) Press the **Menu Select** button directly below **Sel** to select the required radio profile, or press the **Menu Select** button directly below **Exit** to exit the screen without making any changes.

The radio returns to the Home screen. The profile name on the Home screen indicates the current selected radio profile.

---

### Enabling and Disabling the Radio Alias

This feature allows you to display or hide the radio alias (name).

Press the **Menu Select** button directly below **MyID**.

---

The display shows momentary **Radio ID off**, and the radio alias disappears from the Home screen or



the display shows momentary **Radio ID on**, and the radio alias appears on the Home screen.

## Selecting the Audio Speaker

Your radio must be preprogrammed to allow you to use this feature.

This feature allows you to select the speaker route for the radio's audio from either the main or the secondary speaker using the radio profile settings. While both speakers function together with the secondary speaker enhancing intelligibility of the received audio during typical radio operation, each speaker has an independently-tuned frequency response and volume level operation.

The secondary speaker also has a "whisper" mode with a modified volume taper for quieter modes of operation.



### Note

If an external speaker or microphone accessory is attached to the radio, neither internal speaker is operational as audio is routed to the accessory.

The following methods are options on how to select the audio speaker. The result of all the methods is the same. You can use the options interchangeably

depending on your preference and the programmed functions.

- Select the audio speaker via the preprogrammed **Profile** button:
  - a) Press the preprogrammed **Profile** button.
  - b) ▲ or ▼ to scroll through the menu selections.
  - c) Press the **Menu Select** button directly below **Sel** to select the radio profile with the required speaker routing or press the **Menu Select** button directly below **Exit** to exit the screen without making any changes. The radio returns to the Home screen. The profile name on the Home screen indicates the current selected radio profile.

---

- Select the audio speaker via the radio menu **Prfl**:
  - a) ◀ or ▶ to **Prfl**.
  - b) To access the **Profiles** feature screen, press the **Menu Select** button directly below **Prfl**.
  - c) ▲ or ▼ to scroll through the menu selections.
  - d) Press the **Menu Select** button directly below **Sel** to select the radio profile with the required speaker routing or press the **Menu Select**

button directly below **Exit** to exit the screen without making any changes. The radio returns to the Home screen. The profile name on the Home screen indicates the current selected radio profile.

- To toggle the backlight on or off, press the preprogrammed **Light/Flip** button.
- To turn the backlight on, press either the **Menu Select** or **Navigation** button, or any programmable radio controls or buttons.

---

## Controlling the Display Backlight

You can enable or disable the radio's display backlight as needed, if poor light conditions make the display or keypad difficult to read.

Depending on how your radio is preprogrammed, you can also maintain a minimum backlight level on the radio's front display.



### Note

The backlight setting also affects the **Menu Select** buttons and **Navigation** button backlighting accordingly.

The backlight remains on for a preprogrammed time before it automatically turns off completely or returns to the minimum backlight level.

Perform one of the following actions:

---

## Locking and Unlocking the Controls

You can lock your radio keypad, programmable buttons, and knob or knobs to avoid inadvertent entry. Check with your dealer or qualified technician for best selection to suit your usage.

- 1 Toggle the preprogrammed **Keypad/Control Lock** button to on.  
The display shows **Kypd/Ctrl Lock**.

- 2 Toggle again to unlock the controls.

---

## Turning the Controls and Buttons Tones On or Off

You can enable and disable the tones of Navigation buttons and controls if needed.

- Turning the tones on or off via the preprogrammed **Mute** button:
  - a) To turn the tones off or on, press the preprogrammed **Mute** button.

- Turning the tones on or off via the radio menu:
  - a) ◀ or ▶ to Mute.
  - b) Press the **Menu Select** button directly below Mute.  
The display shows momentary Tones off, indicating that the tones are disabled or the display shows momentary Tones on, and you hear a short tone indicating that the tones are enabled.

---

### Turning Voice Mute On or Off

You can enable and disable voice transmission, if needed.

The following methods are options on how to turn Voice Mute on or off. The result of all the methods is the same. You can use the options interchangeably depending on your preference and the programmed functions.

- Turning Voice Mute off or on via the preprogrammed **Voice Mute** button:
  - a) To turn the feature off or on, press the preprogrammed **Voice Mute** button.
- Turning Voice Mute on or off via the radio menu:

- a) ◀ or ▶ to VMut.
- b) Press the **Menu Select** button directly below VMut.

---

The display shows momentary Voice mute off, and you hear a short tone, indicating that the feature is disabled or the display shows momentary Voice mute on, and you hear a short tone, indicating that the feature is enabled.

### Using the Time-Out Timer

This feature turns off the transmitter of your radio. You cannot transmit longer than the preset timer setting.

If you attempt to do so, the radio automatically stops your transmission, and you hear a talk-prohibit tone.

The timer is defaulted at 60 seconds, but it can be preprogrammed from 3 to 120 seconds, in 15-second intervals, or it can be disabled entirely for each radio mode, by a qualified radio technician.



#### Note

You hear a brief, low-pitched, warning tone four seconds before the transmission times out.

- 1 Hold down the **PTT** button longer than the preprogrammed time.  
You hear a short, low-pitched warning tone, the transmission is cut-off, and the LED goes out until you release the **PTT** button.

---

- 2 Release the **PTT** button.  
The timer resets.

---

- 3 To re-transmit, press the **PTT** button.  
The time-out timer restarts and the LED lights up solid red.

---

## Time and Date Setup

You can set the time and date for your radio.

Settings:

- The default time setting is a 12-hour clock. The display shows 12:00AM.
- The AM/PM selection is not available for the 24-hour clock setting.
- The default setting for the domestic date shows MDY.



### Note

Check with your dealer or system administrator for additional programmable settings for this feature.

## Editing the Time and Date

- 1 ◀ or ▶ to Clck.

---

- 2 Press the **Menu Select** button directly below Clck.  
The display shows the current setting of the radio.

---

- 3 Press the **Menu Select** button directly below Edit.  
The first item blinks.

---

- 4 Perform one of the following actions:
  - ▲ or ▼ to change the selected item.
  - ◀ or ▶ one or more times to move to an item you wish to change. ▲ or ▼ to change the selected item.
  - Press the **Menu Select** button directly below Exit to exit the screen without making any changes and return to the Home screen.

---

- 5 Perform one of the following actions:

- Press the **Menu Select** button directly below **Ok** once you have finished to save your changes and return to the Home screen.
- Press the **Menu Select** button directly below **Disc1** to discard all changes and return to the Home screen.

Press  at any time to return to the Home screen without saving your changes.



#### Note

If a call arrives while the radio is in the clock-setting menu, the radio exits clock setting and displays the call information. Any changes made before the call is **not** saved.

## Using Conventional Squelch Operation Features

This feature filters out unwanted calls with low signal strength or channels that have a higher than normal background noise.

### Analog Options

Tone Private Line (PL), Digital Private-Line (DPL), and carrier squelch can be available (preprogrammed) per channel.

Mode	Result
Carrier squelch (C)	You hear all traffic on a channel.
PL or DPL	The radio responds only to your messages.

### Digital Options

One or more of the following options may be preprogrammed in your radio. Check with your dealer or system administrator for more information.

Option	Result
Digital Carrier-Operated Squelch (COS)	You hear any digital traffic.
Normal Squelch	You hear any digital traffic having the correct network access code.
Selective Switch	You hear any digital traffic having the correct network access code and correct talkgroup.

## Using the PL Defeat Feature

This feature allows you to override any coded squelch (DPL or PL) that might be preprogrammed to a channel. The radio also unmutes to any digital activity on a digital channel.

Place the preprogrammed **PL Defeat** switch in the PL Defeat position.

One of the following scenarios occurs:

- You hear any activity on the channel.
- The radio is muted if no activity is present.



### Note

When this feature is active, the Carrier Squelch status indicator is displayed.

ID of your radio is sent continuously during the voice message.

## Smart PTT Feature (Conventional Only)

Smart **PTT** is a per-personality, programmable feature used in conventional radio systems to keep radio users from talking over other radio conversations.

When smart **PTT** is enabled in your radio, you cannot transmit on an active channel.

If you try to transmit on an active smart-**PTT** channel, you hear an alert tone, and the transmission is inhibited. The LED lights up solid yellow to indicate that the channel is busy.

The following table shows the variations of smart **PTT**:

Mode	Description
Transmit Inhibit on Busy Channel with Carrier	You cannot transmit if any traffic is detected on the channel.

## Digital PTT ID Support

This feature allows you to see the radio ID (number) of the radio from whom you are currently receiving a transmission. This ID, consisting up to a maximum of eight characters, can be viewed by both the receiving radio and the dispatcher.

The ID number of your radio is also automatically sent every time the **PTT** button is pressed. This is a per-channel feature. For digital voice transmissions, the

Mode	Description
Transmit Inhibit on Busy Channel with Wrong Squelch Code	You cannot transmit on an active channel with a squelch code or (if secure-equipped) encryption key other than your own. If the PL code is the same as yours, the transmission is not prevented.
Quick-Key Override	Your radio must be preprogrammed to allow you to use Quick-Key Override. This feature can work in conjunction with either of the two above variations. You can override the transmit-inhibit state by quick-keying the radio. In other words, two <b>PTT</b> button presses within the preprogrammed time limit.

## Transmit Inhibit

This feature is available for APCO 25 trunking, Type II trunking and Conventional operations for all APX radios.

When Transmit Inhibit feature is enabled, the radio stops all transmission including voice and data. The

radio could receive messages but not replying the acknowledgement request of the received message.

User could physically control the transmission of the radio especially during operation in hazardous environments with this feature. An environment is considered hazardous when the power emitted by the radio power amplifier could initiate an explosion or other dangerous reactions.

When the Transmit Inhibit feature is disabled, the radio functions according to its normal operations.

The radio sounds alert tone when user enters or exits this feature and also when **PTT** is pressed.



### Note

Acknowledgement of any messages required from the radio is not transmitted if the Transmit Inhibition is enabled.

## Enabling Transmit Inhibition

Perform one of the following actions:

- Switch the preprogrammed Transmit Inhibit switch to Transmit Inhibit enabled.
- ◀ or ▶ to TxIn. Press the **Menu Select** button below TxIn.

- Press the Transmit Inhibit programmable button.



**Note**

If the user has disabled TX Inhibit via the menu and then moves the switch to the position where TX Inhibit is enabled, the new value overwrites the menu value.

The display shows `Tx inhibit on`. You hear a sequence of short, low-high tones to indicate transmission is inhibited.

---

Pressing **PTT** triggers the radio sounds a constant short, low-pitched tone (reject tone).



**Note**

The status of the Transmit Inhibit does not change after the radio powers up.

**Disabling Transmit Inhibition**

Perform one of the following actions:

- ◀ or ▶ to TxIn. Press the **Menu Select** button below TxIn.
- Press the Transmit Inhibit programmable button.



**Note**

If the user has disabled TX Inhibit via the softkey and then moves the switch to the position where TX Inhibit is enabled, the new value overwrites the menu value.

The display shows `Tx inhibit off`. You hear a sequence of short, high-low tone (Transmit Inhibit Off tone) to indicate transmission is back to normal operation.

---

**IMPRES Battery Annunciator**



This feature displays the current capacity and charges cycles of your battery when an IMPRES™ Battery is powering your radio. This feature must be enabled in your radio to see the information.

The information shown are:

<b>Charge Percentage</b>	Percentage of current battery capacity.
<b>Remaining Capacity</b>	Remaining power of the battery in mAh.
<b>Estimated Charges</b>	Number of charges cycles the battery has gone through.



## Accessing the Battery Info screen

- 1  or  to Batt.

---

- 2 Press the **Menu Select** button directly below Batt.  
The display shows the details of the battery.

---

- 3 To return to the Home screen, press the **Menu Select** button directly below Exit.

## General Radio Information

Your radio contains information on the following:

- Radio Information
- IP Display
- Control Assignments
- Soft ID (If enabled)



### Note

The radio automatically exits the feature, if the feature inactivity timer is enabled, when the radio is left idle and the timer expires. You hear the Menu Inactive Exit Tone upon feature exit.

## Accessing the Radio Information

This feature displays the following radio information:

- Host Version
- Secure Version
- Model Number
- ESN
- Flash Code
- Tuning Version
- Option Board Type (optional)
- Option Board Bluetooth Address (optional)
- Expansion Board Type (optional)
- MFK Secondary Function
- DSP Version
- KG (Secure Algorithm)
- Serial Number
- Flash Size & Type
- RF Band(s)
- Processor Version
- Option Board Serial Number (optional)
- Option Board Software Version (optional)
- Language Pack ID and Version (only when the language of the display is set to non-English)



### Note

To return to the Home screen, press at any time.

- 1 Perform one of the following actions:
  - Press the preprogrammed **Info** button.
  - or to **Info** and press the **Menu Select** button directly below **Info**.

---

- 2 or to **Radio Info** and press the **Menu Select** button directly below **Sel**.  
The display shows the Information screen.

---

- 3 Perform one of the following actions:
  - or to scroll through the various information.
  - To return to the previous screen, press the **Menu Select** button directly below **Back**.
  - Press to return to the Home screen .

### ***Viewing the IP Information***

This feature displays the device name, IP address, and status of your radio.



### Note

The device name of your radio is preprogrammed. Check with your dealer or system administrator for more information.

- 1 Perform one of the following actions:
  - Press the preprogrammed **Info** button.
  - or to **Info** and press the **Menu Select** button directly below **Info**.

---

- 2 or to **IP Info** and press the **Menu Select** button directly below **Sel**.  
The display shows the IP Info screen.

---



- 3 Perform one of the following actions:
  - or to scroll through the various information.
  - Press the **Menu Select** button directly below **Back** to return to the previous screen.
  - Press to return to the Home screen.



### ***Viewing the Control Assignments***

This feature displays the programmable radio functions assigned to the controls of your radio for the currently selected channel.

See [Programmable Features](#) on page 33 for more information on the various programmable features of your radio.



1 Perform one of the following actions:

- Press the preprogrammed **Info** button.
  -  or  to **Info** and press the **Menu Select** button directly below **Info**.
- 

2  or  to **Control map** and press the **Menu Select** button directly below **Sel**.  
The display shows the Control Map screen.

---

3 Perform one of the following actions:

-  or  to scroll through the various information.
  - Press the **Menu Select** button directly below **Back** to return to the previous screen.
  - Press  to return to the Home screen.
-

## Helpful Tips

### Radio Care



#### Caution

- Your radio casing has a vent port that allows for pressure equalization in the radio. Never poke this vent <sup>Ⓐ</sup> with any objects, such as needles, tweezers, or screwdrivers. This could create leak paths into the radio and the radio's submergibility will be lost.



See the following picture for **MFK** radio.

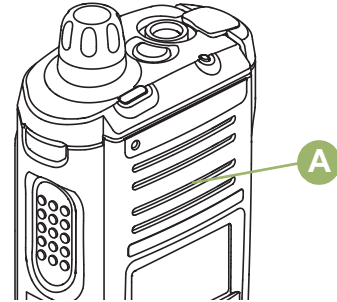

See the following picture for **two knobs** radio.

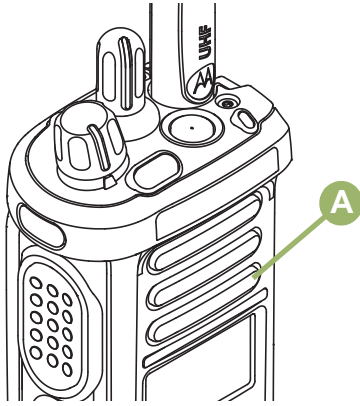

- The radio with antenna attached properly is designed to be submersible to a maximum depth of 1 meter (3.28 feet) and a maximum submersion time of 30 minutes. Exceeding either maximum limit or use without antenna may result in damage to the radio.
- If the radio battery contact area has been submerged in water, dry and clean the radio battery contacts before attaching a battery to the radio. Otherwise, the water could short-circuit the radio.
- If the radio has been submerged in water, shake the radio well so that any water that may be trapped inside the speaker grille and microphone port can be removed. Otherwise, the water will decrease the audio quality of the radio.
- Do not submerge the radio as this results in damage to the radio.
- If water is observed on the battery contact area, dry and clean the radio battery contacts before attaching a battery to the radio. Otherwise, the water could short-circuit the radio.
- If water is observed on the speaker grill area, shake the radio well so that any water that may be trapped inside the speaker grille and microphone port can be removed. Otherwise, the water will decrease the audio quality of the radio.
- Do **not** disassemble the radio. This could damage radio seals and result in leak paths into the radio. Any radio maintenance should be performed only by a qualified radio technician.

## Cleaning Your Radio



### Caution

Do **not** use solvents to clean your radio as most chemicals may permanently damage the radio housing and textures.

Do **not** submerge the radio in the detergent solution.

To clean the external surfaces of your radio, follow the procedure described next.

- 1 Combine one teaspoon of mild dishwashing detergent to one gallon of water (0.5% solution).

---

- 2 Apply the solution sparingly with a stiff, non-metallic, shortbristled brush, making sure excess detergent does not get entrapped near the connectors, controls or crevices. Dry the radio thoroughly with a soft, lint-free cloth.

---

- 3 Clean battery contacts with a lint-free cloth to remove dirt or grease.

---

## Proper Ways to Handle the Radio

- Do **not** pound, drop, or throw the radio unnecessarily. Never carry the radio by the antenna.
- Avoid subjecting the radio to an excess of liquids.
- Do **not** submerge the radio.
- Avoid subjecting the radio to corrosives, solvents or chemicals.
- Do **not** disassemble the radio.
-  **Caution**  
Do **not** use the radio without an accessory connector or a dust cover in place as contamination can build up on the contacts.
- When charging the radio using a wall mounted charger, the radio must be turned off. Otherwise, the Man Down Alert and Emergency may be accidentally triggered.

## Radio Service and Repair

Proper repair and maintenance procedures will assure efficient operation and long life for this product. A Motorola maintenance agreement will provide expert service to keep this and all other communication equipment in perfect operating condition. A nationwide service organization is

provided by Motorola to support maintenance services. Through its maintenance and installation program, Motorola makes available the finest service to those desiring reliable, continuous communications on a contract basis. For a contract service agreement, please contact your nearest Motorola service or sales representative, or an authorized Motorola dealer.

## Battery Care

### Battery Charge Status

Your radio can indicate the battery's charge status through:

- the LED and sounds.
- the fuel gauge icon on the display.

You can also check the battery charge status via the menu entry. See [IMPRES Battery Annunciator](#) on page 116 for more information.





### LED and Sounds

When your battery is low:

- the LED blinks red when the **PTT** button is pressed.
- you hear a low-battery “chirp” (short, high-pitched tone).

### Fuel Gauge Icons

A blinking fuel gauge icon () is displayed only when the battery voltage drops to low level. In this case, replace the battery with a fully charged one.

Gauge	Battery Charge
	76% to 100% full <sup>[3]</sup>
	51% to 75% <sup>[3]</sup>
	26% to 50% <sup>[3]</sup>
	11% to 25% <sup>[3]</sup>
	10% or less (at 10%, the gauge begins blinking)

## Battery Recycling and Disposal

In the U.S. and Canada, Motorola participates in the nationwide Rechargeable Battery Recycling Corporation (RBRC) program for battery collection and recycling. Many retailers and dealers participate in this program.

For the location of the drop-off facility closest to you, access RBRC's Internet web site at [www.rbrc.com](http://www.rbrc.com) or call 1-800-8-BATTERY. This internet site and telephone number also provide other useful information concerning recycling options for consumers, businesses, and governmental agencies.



## Accessories

The accessory link below is for APX radios. Not all accessories are FCC certified to operate with all APX models and/or bandsplits. Please refer to the specific APX radio price pages for a list of FCC certified accessories or contact your sales representative for accessory compatibility.

<http://www.motorolasolutions.com/APX>



### Note

Only the following programming cables are compatible with the radios.

- APX DMR Port Programming Cable (PMKN4012B)
- Test and Alignment Programming Cable (PMKN4013C)

## Maritime Radio Use in the VHF Frequency Range

### Special Channel Assignments

---

#### Emergency Channel

If you are in imminent and grave danger at sea and require emergency assistance, use VHF Channel 16 to send a distress call to nearby vessels and the United States Coast Guard. Transmit the following information, in this order:

- 1 “MAYDAY, MAYDAY, MAYDAY.”
- 2 “THIS IS \_\_\_\_\_, CALL SIGN \_\_\_\_\_.” State the name of the vessel in distress 3 times, followed by the call sign or other identification of the vessel, stated 3 times.
- 3 Repeat “MAYDAY” and the name of the vessel.
- 4 “WE ARE LOCATED AT \_\_\_\_\_.” State the position of the vessel in distress, using any information that will help responders to locate you, e.g.:
  - latitude and longitude
  - bearing (state whether you are using true or magnetic north)

- distance to a well-known landmark
  - vessel course, speed or destination
- 5 State the nature of the distress.
  - 6 Specify what kind of assistance you need.
  - 7 State the number of persons on board and the number needing medical attention, if any.
  - 8 Mention any other information that would be helpful to responders, such as type of vessel, vessel length and/or tonnage, hull color, etc.
  - 9 “OVER.”
  - 10 Wait for a response.
  - 11 If you do not receive an immediate response, remain by the radio and repeat the transmission at intervals until you receive a response. Be prepared to follow any instructions given to you.

#### Non-Commercial Call Channel

For non-commercial transmissions, such as fishing reports, rendezvous arrangements, repair scheduling, or berthing information, use **VHF Channel 9**.

### Operating Frequency Requirements

---

A radio designated for shipboard use must comply with Federal Communications Commission Rule Part 80 as follows:

- on ships subject to Part II of Title III of the Communications Act, the radio must be capable of operating on the 156.800 MHz frequency.
- on ships subject to the Safety Convention, the radio must be capable of operating:
  - in the simplex mode on the ship station transmitting frequencies specified in the 156.025 – 157.425 MHz frequency band, and
  - in the semiduplex mode on the two frequency channels specified in the table below.



**Note**

Simplex channels 3, 21, 23, 61, 64, 81, 82, and 83 cannot be lawfully used by the general public in US waters.

Additional information about operating requirements in the Maritime Services can be obtained from the full text of FCC Rule Part 80 and from the US Coast Guard.

**Table 1: VHF Marine Channel List**

Channel Number	Frequency (MHz)	
	Transmit	Receive

1	156.050	160.650
2	156.100	160.700
*	156.150	160.750
4	156.200	160.800
5	156.250	160.850
6	156.300	–
7	156.350	160.950
8	156.400	–
9	156.450	156.450
10	156.500	156.500
11	156.550	156.550
12	156.600	156.600
13**	156.650	156.650
14	156.700	156.700
15**	156.750	156.750
16	156.800	156.800
17**	156.850	156.850

18	156.900	161.500
19	156.950	161.550
20	157.000	161.600
*	157.050	161.650
22	157.100	161.700
*	157.150	161.750
24	157.200	161.800
25	157.250	161.850
26	157.300	161.900
27	157.350	161.950
28	157.400	162.000
60	156.025	160.625
*	156.075	160.675
62	156.125	160.725
63	156.175	160.775
*	156.225	160.825
65	156.275	160.875

66	156.325	160.925
67**	156.375	156.375
68	156.425	156.425
69	156.475	156.475
71	156.575	156.575
72	156.625	–
73	156.675	156.675
74	156.725	156.725
75	***	***
76	***	***
77**	156.875	–
78	156.925	161.525
79	156.975	161.575
80	157.025	161.625
*	157.075	161.675
*	157.125	161.725
*	157.175	161.775

84	157.225	161.825
85	157.275	161.875
86	157.325	161.925
87	157.375	161.975
88	157.425	162.025



**Note**

\* Simplex channels 3, 21, 23, 61, 64, 81, 82, and 83 cannot be **lawfully used** by the general public in US waters.

\*\* Low power (1 W) only.

\*\*\* Guard band.



**Note**

A – in the Receive column indicates that the channel is transmit only.

maritime use when it operates on the distress and safety frequencies specified in RSS-182 Section 7.3.

**Technical Parameters for Interfacing External Data Sources**

	RS232	USB	SB9600
<b>Input Voltage (Volts Peak-to-peak)</b>	18V	3.6V	5V
<b>Max Data Rate</b>	28 kb/s	12 Mb/s	9.6 kb/s
<b>Impedance</b>	5000 ohm	90 ohm	120 ohm

**Declaration of Compliance for the Use of Distress and Safety Frequencies**

The radio equipment does not employ a modulation other than the internationally adopted modulation for

## Glossary

This glossary is a list of specialized terms used in this manual.

<b>ACK</b>	Acknowledgment of communication.
<b>Active Channel</b>	A channel that has traffic on it.
<b>Analog Signal</b>	An RF signal that has a continuous nature rather than a pulsed or discrete nature.
<b>ARS</b>	Automatic Registration Service
<b>ASTRO 25</b>	Motorola standard for wireless digital trunked communications.
<b>ASTRO Conventional</b>	Motorola standard for wireless digital conventional communications.
<b>Autoscan</b>	A feature that allows the radio to automatically scan the members of a scan list.
<b>Call Alert</b>	Privately page an individual by sending an audible tone.



**Carrier Squelch** Feature that responds to the presence of an RF carrier by opening or unmuting (turning on) a receiver's audio circuit. A squelch circuit silences the radio when no signal is being received so that the user does not have to listen to "noise".

**Central Controller** A software-controlled, computer-driven device that receives and generates data for the trunked radios assigned to it. It monitors and directs the operations of the trunked repeaters.

**Channel** A group of characteristics such as transmit/ receive frequency pairs, radio parameters, and encryption encoding.

**Control Channel** In a trunking system, one of the channels that is used to provide a continuous, two-way/ data communications path between the central controller and all radios on the system.

<b>Conventional</b>	Typically refers to radio-to-radio communications, sometimes through a repeater (see Trunking).	<b>ESN</b>	Electrical Serial Number
<b>Conventional Scan List</b>	A scan list that includes only conventional channels.	<b>Failsoft</b>	A feature that allows communications to take place even though the central controller has failed. Each trunked repeater in the system transmits a data word informing every radio that the system has gone into failsoft.
<b>Digital Private Line (DPL)</b>	A type of coded squelch using data bursts. Similar to PL except a digital code is used instead of a tone.	<b>FCC</b>	Federal Communications Commission.
<b>Digital Signal</b>	An RF signal that has a pulsed, or discrete, nature, rather than a continuous nature.	<b>FM</b>	Frequency Modulation
<b>Dispatcher</b>	An individual who has radio system management duties.	<b>Hang Up</b>	Disconnect.
<b>DSP</b>	Digital Signal Processing	<b>Home screen</b>	The first display information after the radio completes its self test.
<b>Dynamic Regrouping</b>	A feature that allows the dispatcher to temporarily reassign selected radios to a single special channel so they can communicate with each other.	<b>IV&amp;D</b>	Integrated Voice and Data
<b>DSR</b>	Dynamic System Resilience	<b>LCD</b>	Liquid crystal display.
		<b>LED</b>	Light-emitting diode.
		<b>MCW</b>	Mission Critical Wireless
		<b>MDC</b>	Motorola Data Communication

<b>Menu Entry</b>	A software-activated feature shown at the bottom of the display – selection of these features is controlled by the  ,  , and  buttons.	<b>Network Access Code</b>	Network Access Code (NAC) operates on digital channels to reduce voice channel interference between adjacent systems and sites.
<b>Monitor</b>	Check channel activity by pressing the Monitor button. If the channel is clear, you hear static. If the channel is in use, you hear conversation. It also serves as a way to check the volume level of the radio, since the radio “opens the squelch” when the monitor button is pressed.	<b>Non-Tactical/ Revert</b>	The user talks on a preprogrammed emergency channel. The emergency alarm is sent out on this same channel.
<b>Multi-Function Knob</b>	It works as a power on/off button, provides primary and secondary functions like volume change and mode change.	<b>Page</b>	A one-way alert, with audio and/or display messages.
<b>Multi-System Talkgroup Scan List</b>	A scan list that can include both talkgroups (trunked) and channels (conventional).	<b>Personality</b>	A set of unique features specific to a radio.
		<b>Preprogrammed</b>	Refers to a software feature that has been activated by a qualified radio technician.
		<b>Private (Conversation) Call</b>	A feature that lets you have a private conversation with another radio user in the talkgroup.



<b>Private Line (PL)</b>	A sub-audible tone that is transmitted such that only receivers decoding the tone receives it.	<b>Selective Switch</b>	Any digital P25 traffic having the correct Network Access Code and the correct talkgroup.
<b>Programmable</b>	Refers to a radio control that can have a radio feature assigned to it.	<b>Squelch</b>	Special electronic circuitry, added to the receiver of a radio, that reduces, or cuts off, unwanted signals before they are heard in the speaker.
<b>PTT</b>	Push-To-Talk. The <b>PTT</b> button engages the transmitter and puts the radio in transmit (send) operation when pressed.	<b>Standby</b>	An operating condition whereby the radio's speaker is muted but still continues to receive data.
<b>Radio Frequency (RF)</b>	The part of the general frequency spectrum between the audio and infrared light regions (about 10 kHz to 10,000,000 MHz).	<b>Status Calls</b>	Pre-defined text messages that allow the user to send a conditional message without talking.
<b>Repeater</b>	A conventional radio feature, where you talk through a receive/transmit facility that re-transmits received signals, in order to improve communications range and coverage.	<b>Tactical/ Non-Revert</b>	The user talks on the channel that was selected before the radio entered the emergency state.
		<b>Talkaround</b>	Bypass a repeater and talk directly to another unit for easy local unit-to-unit communications.

<b>Talkgroup</b>	An organization or group of radio users who communicate with each other using the same communication path.		constantly synchronizing with each other. Abbreviated as UTC (English backronym = Universal Time, Coordinated), it is also known as Zulu (Z) Time.
<b>TMS</b>	Text Messaging Service		
<b>Trunking</b>	The automatic sharing of communications paths between a large number of users (see Conventional).	<b>Zone</b>	A grouping of channels.
<b>Trunking Priority Monitor Scan List</b>	A scan list that includes talkgroups that are all from the same trunking system.		
<b>UTC</b>	Coordinated Universal Time. The international time standard (formerly Greenwich Mean Time, or GMT). Zero hours UTC is midnight in Greenwich, England, which is located at 0 degrees longitude. Everything east of Greenwich (up to 180 degrees) is later in time; everything west is earlier. There are 42 time authorities around the world that are		

## Limited Warranty

### MOTOROLA COMMUNICATION PRODUCTS

#### I. WHAT THIS WARRANTY COVERS AND FOR HOW LONG:

MOTOROLA SOLUTIONS, INC. (“MOTOROLA”) warrants the MOTOROLA manufactured Communication Products listed below (“Product”) against defects in material and workmanship under normal use and service for a period of time from the date of purchase as scheduled below:

ASTRO APX 1000 Portable Units	One (1) Year
Product Accessories	One (1) Year

For LACR region:

ASTRO APX 1000 Portable Units	Three (3) Years
Product Accessories	One (1) Year

MOTOROLA, at its option, will at no charge either repair the Product (with new or reconditioned parts), replace it (with a new or reconditioned Product), or refund the purchase price of the Product during the warranty period provided it is returned in accordance with the terms of this warranty. Replaced parts or boards are warranted for the balance of the original applicable warranty period. All replaced parts of Product shall become the property of MOTOROLA.

This express limited warranty is extended by MOTOROLA to the original end user purchaser only and is not assignable or transferable to any other party. This is the complete warranty for the Product manufactured by MOTOROLA. MOTOROLA assumes no obligations or liability for additions or modifications to this warranty unless made in writing and signed by an officer of MOTOROLA.

Unless made in a separate agreement between MOTOROLA and the original end user purchaser, MOTOROLA does not warrant the installation, maintenance or service of the Product.

MOTOROLA cannot be responsible in any way for any ancillary equipment not furnished by MOTOROLA which is attached to or used in connection with the Product, or for operation of the Product with any

ancillary equipment, and all such equipment is expressly excluded from this warranty. Because each system which may use the Product is unique, MOTOROLA disclaims liability for range, coverage, or operation of the system as a whole under this warranty.

MOTOROLA offers the following optional extended service contracts.

### **SERVICE FROM THE START (SfS) COMPREHENSIVE**

Provides for extended hardware repair coverage INCLUDING CHEMICAL, LIQUID, FIRE, AND OTHER PHYSICAL DAMAGE. Comprehensive coverage is available in conjunction with MOTOROLA'S standard Commercial Warranty and starts from the FIRST DAY the radio is put into use. Service performed under this plan consists of repair or replacement of the covered equipment as set forth in the terms and conditions. Repairs will be made only at the designated MOTOROLA repair depot. Local services are not included. MOTOROLA will pay the inbound shipping charges only with use of the MOTOROLA designated delivery service. MOTOROLA will pay for outbound shipping via MOTOROLA'S normal shipping methods.

### **SERVICE FROM THE START (SfS) LITE**

Provides extended hardware normal wear and tear repair coverage beginning AFTER MOTOROLA'S standard Commercial Warranty period expires. Service performed under this plan consists of repair of the covered equipment as set forth in the terms and conditions. Repairs will be made only at the designated MOTOROLA repair depot. Local services are not included. MOTOROLA will pay for outbound shipping via MOTOROLA'S normal shipping methods.

## **II. GENERAL PROVISIONS:**

---

This warranty sets forth the full extent of MOTOROLA'S responsibilities regarding the Product. Repair, replacement or refund of the purchase price, at MOTOROLA'S option, is the exclusive remedy. THIS WARRANTY IS GIVEN IN LIEU OF ALL OTHER EXPRESS WARRANTIES. IMPLIED WARRANTIES, INCLUDING WITHOUT LIMITATION, IMPLIED WARRANTIES OF MERCHANTABILITY AND FITNESS FOR A PARTICULAR PURPOSE, ARE LIMITED TO THE DURATION OF THIS LIMITED WARRANTY. IN NO EVENT SHALL MOTOROLA BE LIABLE FOR DAMAGES IN EXCESS OF THE PURCHASE PRICE OF THE

PRODUCT, FOR ANY LOSS OF USE, LOSS OF TIME, INCONVENIENCE, COMMERCIAL LOSS, LOST PROFITS OR SAVINGS OR OTHER INCIDENTAL, SPECIAL OR CONSEQUENTIAL DAMAGES ARISING OUT OF THE USE OR INABILITY TO USE SUCH PRODUCT, TO THE FULL EXTENT SUCH MAY BE DISCLAIMED BY LAW.

### **III. STATE LAW RIGHTS:**

---

SOME STATES DO NOT ALLOW THE EXCLUSION OR LIMITATION OF INCIDENTAL OR CONSEQUENTIAL DAMAGES OR LIMITATION ON HOW LONG AN IMPLIED WARRANTY LASTS, SO THE ABOVE LIMITATION OR EXCLUSIONS MAY NOT APPLY.

This warranty gives specific legal rights, and there may be other rights which may vary from state to state.

### **IV. HOW TO GET WARRANTY SERVICE:**

---

You must provide proof of purchase (bearing the date of purchase and Product item serial number) in order to receive warranty service and, also, deliver or send the Product item, transportation and insurance

prepaid, to an authorized warranty service location. Warranty service will be provided by MOTOROLA through one of its authorized warranty service locations. If you first contact the company which sold you the Product (e.g., dealer or communication service provider), it can facilitate your obtaining warranty service. You can also call MOTOROLA at 1-800-927-2744 US/Canada.

### **V. WHAT THIS WARRANTY DOES NOT COVER:**

---

- 1 Defects or damage resulting from use of the Product in other than its normal and customary manner.
- 2 Defects or damage from misuse, accident, water, or neglect.
- 3 Defects or damage from improper testing, operation, maintenance, installation, alteration, modification, or adjustment.
- 4 Breakage or damage to antennas unless caused directly by defects in material workmanship.
- 5 A Product subjected to unauthorized Product modifications, disassembles or repairs (including, without limitation, the addition to the Product of non-MOTOROLA supplied equipment) which

adversely affect performance of the Product or interfere with MOTOROLA's normal warranty inspection and testing of the Product to verify any warranty claim.

- 6 Product which has had the serial number removed or made illegible.
- 7 Rechargeable batteries if:
  - any of the seals on the battery enclosure of cells are broken or show evidence of tampering.
  - the damage or defect is caused by charging or using the battery in equipment or service other than the Product for which it is specified.
- 8 Freight costs to the repair depot.
- 9 A Product which, due to illegal or unauthorized alteration of the software/firmware in the Product, does not function in accordance with MOTOROLA's published specifications or the FCC certification labeling in effect for the Product at the time the Product was initially distributed from MOTOROLA.
- 10 Scratches or other cosmetic damage to Product surfaces that does not affect the operation of the Product.
- 11 Normal and customary wear and tear.

## **VI. PATENT AND SOFTWARE PROVISIONS:**

MOTOROLA will defend, at its own expense, any suit brought against the end user purchaser to the extent that it is based on a claim that the Product or parts infringe a United States patent, and MOTOROLA will pay those costs and damages finally awarded against the end user purchaser in any such suit which are attributable to any such claim, but such defense and payments are conditioned on the following:

- 1 that MOTOROLA will be notified promptly in writing by such purchaser of any notice of such claim,
- 2 that MOTOROLA will have sole control of the defense of such suit and all negotiations for its settlement or compromise, and
- 3 should the Product or parts become, or in MOTOROLA's opinion be likely to become, the subject of a claim of infringement of a United States patent, that such purchaser will permit MOTOROLA, at its option and expense, either to procure for such purchaser the right to continue using the Product or parts or to replace or modify the same so that it becomes non-infringing or to grant such purchaser a credit for the Product or parts as depreciated and accept its return. The

depreciation will be an equal amount per year over the lifetime of the Product or parts as established by MOTOROLA.

MOTOROLA will have no liability with respect to any claim of patent infringement which is based upon the combination of the Product or parts furnished hereunder with software, apparatus or devices not furnished by MOTOROLA, nor will MOTOROLA have any liability for the use of ancillary equipment or software not furnished by MOTOROLA which is attached to or used in connection with the Product. The foregoing states the entire liability of MOTOROLA with respect to infringement of patents by the Product or any parts thereof.

Laws in the United States and other countries preserve for MOTOROLA certain exclusive rights for copyrighted MOTOROLA software such as the exclusive rights to reproduce in copies and distribute copies of such MOTOROLA software. MOTOROLA software may be used in only the Product in which the software was originally embodied and such software in such Product may not be replaced, copied, distributed, modified in any way, or used to produce any derivative thereof. No other use including, without limitation, alteration, modification, reproduction, distribution, or reverse engineering of

such MOTOROLA software or exercise of rights in such MOTOROLA software is permitted. No license is granted by implication, estoppel or otherwise under MOTOROLA patent rights or copyrights.

## **VII. GOVERNING LAW:**

---

This Warranty is governed by the laws of the State of Illinois, U.S.A.

## **VIII. For Australia Only**

---

This warranty is given by Motorola Solutions Australia Pty Limited (ABN 16 004 742 312) of Tally Ho Business Park, 10 Wesley Court, Burwood East, Victoria.

Our goods come with guarantees that cannot be excluded under the Australia Consumer Law. You are entitled to a replacement or refund for a major failure and compensation for any other reasonably foreseeable loss or damage. You are also entitled to have the goods repaired or replaced if the goods fail to be of acceptable quality and the failure does not amount to a major failure.

Motorola Solutions Australia's limited warranty above is in addition to any rights and remedies you may

have under the Australian Consumer Law. If you have any queries, please call Motorola Solutions Australia at 1800 457 439. You may also visit our website: [http://www.motorolasolutions.com/XA-EN/Pages/Contact\\_Us](http://www.motorolasolutions.com/XA-EN/Pages/Contact_Us) for the most updated warranty terms.







**MOTOROLA**

Motorola Solutions, Inc.  
1303 East Algonquin Road  
Schaumburg, Illinois 60196 U.S.A.

MOTOROLA, MOTO, MOTOROLA SOLUTIONS and the Stylized M logo are trademarks or registered trademarks of Motorola Trademark Holdings, LLC and are used under license.

All other trademarks are the property of their respective owners.

© 2014 and 2015 Motorola Solutions, Inc. All rights reserved.

June 2015



**MN000254A01-BB**