



## BASIC MANUAL

# COMMUNICATIONS RECEIVER IC-R30

This device complies with Part 15 of the FCC rules. Operation is subject to the following two conditions: (1) This device may not cause harmful interference, and (2) this device must accept any interference received, including interference that may cause undesired operation.

**WARNING:** MODIFICATION OF THIS DEVICE TO RECEIVE CELLULAR RADIOTELEPHONE SERVICE SIGNALS IS PROHIBITED UNDER FCC RULES AND FEDERAL LAW.



Icom Inc.

Thank you for choosing this Icom product. This product is designed and built with Icom's state of the art technology and craftsmanship. With proper care, this product should provide you with years of trouble-free operation.

## ■ Important

**READ ALL INSTRUCTIONS** carefully and completely before using the receiver.

### SAVE THIS INSTRUCTION MANUAL

— This instruction manual contains important operating instructions for the IC-R30.

For advanced features and instructions, see **ADVANCED MANUAL** on the Icom website for details.

## ■ Features

- Dualwatch function that can simultaneously receive and record two different bands or modes\*
  - \* DV/DV, AM/AM, FM-N/FM-N, and DV/FM-N mode dualwatch is not available.
- Covers 0.100 MHz to 3304.99999 MHz for wide band reception
- Receives various digital modes such as D-STAR, APCO P25 (Phase 1), NXDN, dPMR, and DCR (Digital Convenience Radio)
- A USB connector for data transmission or battery charging
- Bluetooth® function that can connect to a Bluetooth® device such as the VS-3
- Built-in GPS receiver to check your current location
- Meets IP57 requirements for dust-protection and waterproof protection (When the battery, antenna, jack cap, and the slot cover are attached)

## ■ Explicit definitions

WORD	DEFINITION
⚠ <b>DANGER!</b>	Personal death, serious injury or an explosion may occur.
⚠ <b>WARNING!</b>	Personal injury, fire hazard or electric shock may occur.
<b>CAUTION</b>	Equipment damage may occur.
<b>NOTE</b>	If disregarded, inconvenience only. No risk of personal injury, fire or electric shock.

Icom is not responsible for the destruction, damage to, or performance of any Icom or non-Icom equipment, if the malfunction is because of:

- Force majeure, including, but not limited to, fires, earthquakes, storms, floods, lightning, other natural disasters, disturbances, riots, war, or radioactive contamination.
- The use of Icom receivers with any equipment that is not manufactured or approved by Icom.

Icom, Icom Inc. and the Icom logo are registered trademarks of Icom Incorporated (Japan) in Japan, the United States, the United Kingdom, Germany, France, Spain, Russia, Australia, New Zealand, and/or other countries.

NXDN is a trademark of Icom Incorporated and JVC KENWOOD Corporation. dPMR is a trademarks of the dPMR MoU Association.

Adobe, Acrobat, and Reader are either registered trademarks or trademarks of Adobe Systems Incorporated in the United States and/or other countries.

Microsoft and Windows are registered trademarks of Microsoft Corporation in the United States and/or other countries.

The Bluetooth word mark and logos are registered trademarks owned by Bluetooth SIG, Inc. and any use of such marks by Icom inc. is under license.

Other trademarks and trade names are those of their respective owners.

---

## ■ FCC Information

This equipment has been tested and found to comply with the limits for a Class B digital device, pursuant to part 15 of the FCC Rules. These limits are designed to provide reasonable protection against harmful interference in a residential installation. This equipment generates, uses and can radiate radio frequency energy and, if not installed and used in accordance with the instructions, may cause harmful interference to radio communications. However, there is no guarantee that interference will not occur in a particular installation.

If this equipment does cause harmful interference to radio or television reception, which can be determined by turning the equipment off and on, the user is encouraged to try to correct the interference by one or more of the following measures:

- Reorient or relocate the receiving antenna.
- Increase the separation between the equipment and receiver.
- Connect the equipment into an outlet on a circuit different from that to which the receiver is connected.
- Consult the dealer or an experienced radio/TV technician for help.

**CAUTION:** Changes or modifications to this device, not expressly approved by Icom Inc., could void your authority to operate this device under FCC regulations.

## ■ IC-R30 and Bluetooth® Interference

Bluetooth uses the 2.4 GHz band. When using the IC-R30 in the 2.4 GHz band near a Bluetooth device, interference may occur. This may cause a decrease in communication speed, and an unstable connection.

In such case, use the IC-R30 away from the Bluetooth device communication area, or stop using the Bluetooth device.

---

## ■ Information FCC

Cet équipement a été testé et reconnu conforme aux limites fixées pour un appareil numérique de classe B, conformément au point 15 de la réglementation FCC. Ces limites ont été fixées afin d'assurer une protection raisonnable contre les interférences nocives dans une installation résidentielle. Cet équipement génère, utilise et peut émettre un rayonnement de fréquence radio. S'il n'a pas été installé conformément aux instructions, il peut par ailleurs créer des interférences perturbant les communications radio. Toutefois, il n'y a aucune garantie que les interférences ne se produiront pas dans une installation particulière.

Si cet équipement crée des interférences perturbant la réception de la radio ou de la télévision, comme cela peut être déterminé en éteignant et en allumant l'équipement, l'utilisateur est invité à essayer de corriger l'interférence en prenant une ou plusieurs des mesures ci-après:

- Réorienter ou changer de place l'antenne de réception.
- Éloigner l'équipement et le récepteur.
- Connecter l'équipement sur une prise sur un autre circuit que celui sur lequel le récepteur est connecté.
- Faire appel au revendeur ou à un technicien radio/TV expérimenté.

**MISE EN GARDE:** Tout changement ou modification, non expressément approuvé par Icom Inc., peut annuler l'autorisation de l'utilisateur à utiliser cet appareil conformément à la réglementation FCC.

## ■ IC-R30 et interférences Bluetooth®

Bluetooth utilise la bande de 2,4 GHz. Si vous utilisez l'IC-R30 dans la bande de 2,4 GHz à proximité d'un appareil Bluetooth, ceci peut provoquer des interférences. Ceci peut réduire le débit de communication et rendre la connexion instable.

Dans ce cas, utilisez l'IC-R30 à distance suffisante de la zone de communication de l'appareil Bluetooth ou cessez d'utiliser l'appareil Bluetooth.

---

## ■ Precautions

⚠ **DANGER! NEVER** operate the receiver near unshielded electrical blasting caps or in an explosive atmosphere. This could cause an explosion and death.

⚠ **WARNING! NEVER** use or charge Icom battery packs with non-Icom receivers or non-Icom chargers. Only Icom battery packs are tested and approved for use with Icom receivers or charged with Icom chargers. Using third-party or counterfeit battery packs or chargers may cause smoke, fire, or cause the battery to burst.

⚠ **WARNING! NEVER** operate the equipment with a headset or other audio accessories at high volume levels. The continuous high volume operation may cause a ringing in your ears. If you experience the ringing, reduce the volume level or discontinue use.

⚠ **WARNING! NEVER** operate the receiver while driving a vehicle. Safe driving requires your full attention— anything less could result in an accident.

**CAUTION: DO NOT** short the terminals of the battery pack. Shorting may occur if the terminals touch metal objects such as a key, so be careful when placing the battery packs (or the receiver) in bags, and so on. Carry them so that shorting cannot occur with metal objects. Shorting may damage not only the battery pack, but also the receiver.

**CAUTION: DO NOT** connect the receiver directly to a power source of more than the specified DC voltage or use reverse polarity. Otherwise this will damage the receiver.

**CAUTION: DO NOT** operate the receiver unless the antenna, battery pack and covers are dry before and after being securely attached. Confirm that the antenna and battery pack are dry before attaching. Exposing the inside to dust or water can damage the receiver. After exposure to water, clean the battery contacts thoroughly with fresh water and dry them completely to remove any water or salt residue.

**CAUTION: DO NOT** use harsh solvents such as Benzine or alcohol when cleaning. This could damage the equipment surfaces. If the surface becomes dusty or dirty, wipe it clean with a soft, dry cloth.

**CAUTION: DO NOT** place or leave the receiver in direct sunlight or in areas with temperatures below  $-20^{\circ}\text{C}$  ( $-4^{\circ}\text{F}$ ) or above  $+60^{\circ}\text{C}$  ( $+140^{\circ}\text{F}$ ).

**BE CAREFUL!** The receiver meets IP57\* requirements for dust-protection and waterproof protection. However, once the receiver has been dropped, waterproof protection cannot be guaranteed because of possible damage to the receiver's case or the waterproof seal.

\* Only when the BP-287 and antenna are attached and [SP/USB] cover and [microSD] slot cover are closed.

**NOTE:** Even when the receiver power is OFF, a slight current still flows in the circuits. Remove the battery pack or batteries from the receiver when not using it for a long time. Otherwise, the installed battery pack or batteries will become exhausted, and will need to be recharged or replaced.

# ■ Battery and charging cautions

## ◇ Battery cautions

Misuse of Li-ion batteries may result in the following hazards: smoke, fire, or the battery may rupture. Misuse can also cause damage to the battery or degradation of battery's performance.

⚠ **DANGER! NEVER** strike or otherwise impact the battery pack. Do not use the battery pack if it has been severely impacted or dropped, or if the pack has been subjected to heavy pressure. Battery pack damage may not be visible on the outside of the case. Even if the surface of the battery does not show cracks or any other damage, the cells inside the battery may rupture or catch fire.

⚠ **DANGER! NEVER** place or leave the battery pack in areas with temperatures above 60°C (140°F). High temperature buildup in the battery cells, such as could occur near fires or stoves, inside a sun-heated vehicle, or in direct sunlight for long periods of time may cause the battery cells to rupture or catch fire. Excessive temperatures may also degrade pack's performance or shorten the battery cell's life.

⚠ **DANGER! NEVER** place or leave battery packs near fire. Fire or heat may cause them to rupture or explode. Dispose of used battery packs in accordance with local regulations.

⚠ **DANGER! NEVER** solder the battery terminals, or **NEVER** modify the battery pack. This may cause heat generation, and the battery may burst, emit smoke or catch fire.

⚠ **DANGER! NEVER** let fluid from inside the battery get in your eyes. This can cause blindness. Rinse your eyes with clean water, without rubbing them, and immediately get medical treatment from an eye doctor. **NEVER** disassemble the battery pack.

⚠ **WARNING! NEVER** use the battery if it emits an abnormal odor, heats up, or is discolored or deformed. If any of these conditions occur, contact your Icom dealer or distributor.

⚠ **WARNING! NEVER** let fluid from inside the battery cells come in contact with your body. If it does, immediately wash with clean water.

⚠ **WARNING! NEVER** put the battery pack in a microwave oven, high-pressure container, or in an induction heating cooker. This could cause a fire, overheating, or cause the battery cells to rupture.

⚠ **CAUTION: DO NOT** expose the battery pack to rain, snow, saltwater, or any other liquids. Do not charge or use a wet pack. If the pack gets wet, be sure to wipe it dry before using.

**CAUTION: DO NOT** use the battery pack outside the specified temperature range, -20°C ~ +60°C (-4°F ~ +140°F). Otherwise this will reduce the pack's performance and battery cell life.

**DO NOT** leave the pack fully charged, completely discharged, or in an excessive temperature environment (above 50°C, 122°F) for an extended period of time. Otherwise a shorter battery pack life could occur. If the battery pack must be left unused for a long time, it must be detached from the receiver after discharging. You may use the pack until the remaining capacity is about half, then keep it safely in a cool dry place in the following temperature range:  
-20°C (-4°F) ~ +50°C (+122°F) (for a month)  
-20°C (-4°F) ~ +40°C (+104°F) (for three months)  
-20°C (-4°F) ~ +20°C (+68°F) (for a year).

**NOTE:** Replace the battery pack with a new one approximately five years after manufacturing, even if it still holds a charge. The material inside the battery material will become weak after a period of time, even with little use. The estimated number of times you can charge the pack is between 300 and 500. Even when the battery appears to be fully charged, the operating time of the receiver may become short when:

- Approximately five years have passed since the battery was manufactured.
- The pack has been repeatedly charged.

---

## ◇ Charging cautions

⚠ **DANGER! NEVER** charge the battery pack in areas with extremely high temperatures, such as near fires or stoves, inside a sun-heated vehicle, or in direct sunlight. Otherwise the safety/protection circuit in the battery will activate, causing the battery cells to stop charging.

⚠ **DANGER! NEVER** charge the receiver during a lightning storm. It may result in an electric shock, cause a fire or damage the receiver. Always disconnect the power adapter before a storm.

⚠ **WARNING! DO NOT** charge or leave the battery in the battery charger beyond the specified time for charging. If the pack is not completely charged by the specified time, stop charging and remove the battery from the battery charger. Continuing to charge the battery beyond the specified time limit may cause a fire, overheating, or the battery may rupture.

⚠ **CAUTION: DO NOT** insert the receiver with the battery pack attached into the charger if they are wet or soiled. This could corrode the battery charger terminals or damage the charger. The charger is not waterproof.

**CAUTION: DO NOT** charge the battery pack outside of the specified temperature range: 15°C ~ 40°C (59°F ~ 104°F). Icom recommends charging the pack at 25°C (77°F). The pack may heat up or rupture if charged out of the specified temperature range. Additionally, battery performance or battery life may be reduced.

---

## ■ Recommendation

**CLEAN THE RECEIVER THOROUGHLY IN A BOWL OF FRESH WATER** after exposure to saltwater, and dry it before operating. Otherwise, the receiver's keys, switches, and controllers may become unusable, due to salt crystallization, and/or the charging terminals of the battery pack may corrode.

**NOTE:** If the receiver's waterproof protection appears defective, carefully clean it with a soft, damp (fresh water) cloth, then dry it before operating. The receiver may lose its waterproof protection if the case, jack cap, or connector cover is cracked or broken, or the receiver has been dropped. Contact your Icom distributor or your dealer for advice.

## ■ Operating theory

Electromagnetic radiation, which has frequencies of 20,000 Hz (20 kHz\*) and above, is called radio frequency (RF) energy because, it is useful in radio transmissions. The IC-R30 receives RF energy from 0.100 MHz\* to 3304.99999 MHz and converts it into audio frequency (AF) energy which in turn actuates a loudspeaker to create sound waves. AF energy is in the range of 20 to 20,000 Hz. \* kHz is an abbreviation of kilohertz or 1000 hertz, MHz is abbreviation of megahertz or 1,000,000 hertz, where hertz is a unit of frequency.

## ■ Operating notes

The IC-R30 may receive its own oscillated frequency, resulting in no reception or only noise reception, on some frequencies. The IC-R30 may receive interference from extremely strong signals on different frequencies or when using an external high-gain antenna.



## ■ Voice coding technology

The AMBE+2™ voice coding Technology embodied in this product is protected by intellectual property rights including patent rights, copyrights and trade secrets of Digital Voice Systems, Inc. This voice coding Technology is licensed solely for use within this Communications Equipment. The user of this Technology is explicitly prohibited from attempting to extract, remove, decompile, reverse engineer, or disassemble the Object Code, or in any other way convert the Object Code into a human-readable form. U.S. Patent Nos. #8,595,002, #8,359,197, #8,315,860, #8,200,497, #7,970,606 and #6,912,495.

## ■ About CE and DOC



Hereby, Icom Inc. declares that the versions of IC-R30 which have the "CE" symbol on the product, comply with

the essential requirements of the Radio Equipment Directive, 2014/53/EU, and the restriction of the use of certain hazardous substances in electrical and electronic equipment Directive, 2011/65/EU. The full text of the EU declaration of conformity is available at the following internet address: <http://www.icom.co.jp/world/support>

## ■ Disposal



The crossed-out wheeled-bin symbol on your product, literature, or packaging reminds you that in the European Union, all electrical and electronic products, batteries, and accumulators (rechargeable batteries) must be taken to designated collection locations at the end of their working life. Do not dispose of these products as unsorted municipal waste. Dispose of them according to the laws in your area.

---

## ■ Important notes

### ◇ When using the GPS receiver

- The GPS receiver is installed under the receiver's top panel. Therefore, when the GPS receiver is activated, do not cover the top with anything that will block the satellite signals.

The GPS receiver is installed here.

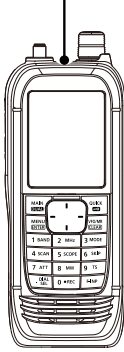

- GPS signals cannot pass through metal objects. When using the receiver inside a vehicle, you may not receive GPS signals. We recommend you use it near a window.
- The GPS receiver may not work if used in the following locations:
  1. Tunnels or high-rise buildings
  2. Underground parking lots
  3. Under a bridge or viaduct
  4. In remote forested areas
  5. Under bad weather conditions (rainy or cloudy day)
- The Global Positioning System (GPS) is built and operated by the U.S. Department of Defense. The Department is responsible for accuracy and maintenance of the system. Any changes by the Department may affect the accuracy and function of the GPS system.

### ◇ Spurious signals

You may hear some noises caused by spurious signals generated in the receiver's circuit but they do not indicate a receiver malfunction.

### ◇ Noise signals while charging

You may hear some noises caused by signals generated in the charging circuit. Be sure to turn OFF the receiver before charging.

## ■ About the IC-R30 manuals

The following manuals are supplied for your IC-R30.

### ◇ Basic manual (This manual)

Instructions for the basic operations, precautions.

### ◇ Advanced manual (PDF on the Icom website)

Instructions for the advanced operations, as shown below.

- Battery operation\*
- Using a microSD card\*
- Recording the received audio\*
- Memory operation\*
- GPS operation\*
- Menu screen\*
- Other functions\*
- Bluetooth® operation\*
- Firmware updating
- Options\*
- Specifications

① This manual can be downloaded from the Icom website.

\*Only the basic instructions are described in this manual.

#### TIP:

You can download each manual from the Icom website:

<http://www.icom.co.jp/world/support>

To read the manual, Adobe® Acrobat® Reader® is required. If you have not installed it, download and install Adobe® Acrobat® Reader® from Adobe Systems Incorporated's website.

## ■ Supplied Accessories



Antenna



Battery pack

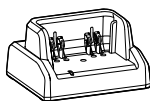

Rapid charger

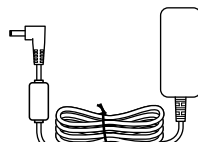

Power adapter



Hand strap

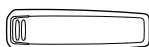

Belt clip

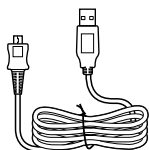

USB cable  
(A-microB type)

**NOTE:** Some accessories are not supplied, or the shape is different, depending on the receiver version.

# TABLE OF CONTENTS

■ Important.....	i	<b>3 BASIC OPERATION .....</b>	<b>11</b>
■ Features.....	i	■ MENU screen.....	11
■ Explicit definitions .....	i	◇ MENU screen operation .....	11
■ FCC Information .....	ii	◇ Selecting a Menu item.....	12
■ IC-R30 and Bluetooth® Interference.ii		■ Quick Menu window.....	13
■ Information FCC.....	iii	■ Setting the squelch level.....	14
■ IC-R30 et interférences Bluetooth®.....	iii	■ Monitor function .....	14
■ Precautions.....	iv	■ Speech function .....	14
■ Battery and charging cautions .....	v	■ Setting the frequency .....	15
◇ Battery cautions.....	v	◇ Directly entering a frequency.....	15
◇ Charging cautions .....	vi	◇ Changing the frequency	
■ Recommendation.....	vii	in MHz steps.....	15
■ Operating theory .....	vii	◇ Selecting the tuning step.....	16
■ Operating notes .....	vii	■ Selecting the Frequency	
■ Voice coding technology .....	viii	Selecting mode.....	16
■ About CE and DOC.....	viii	◇ Variable Frequency Oscillator	
■ Disposal .....	viii	(VFO) mode .....	16
■ Important notes .....	ix	◇ Memory mode .....	16
◇ When using the GPS receiver.....	ix	■ Selecting the receive mode.....	17
◇ Spurious signals.....	ix	■ Selecting the receive band.....	17
◇ Noise signals while charging.....	ix	■ DIAL/VOL Switch function.....	18
■ About the IC-R30 manuals.....	x	■ Setting the RF gain .....	18
◇ Basic manual (This manual).....	x	■ Attenuator .....	18
◇ Advanced manual		■ Dualwatch function.....	19
(PDF on the Icom website) .....	x	◇ Turning Dualwatch function	
■ Supplied Accessories.....	x	ON or OFF.....	19
		◇ Selecting the MAIN band.....	20
		◇ Setting the volume	
		for Dualwatch .....	20
		■ Key Lock function.....	20
		■ Band Scope function.....	21
		◇ Sweep operation .....	22
<b>1 PREPARATION.....</b>	<b>1</b>	<b>4 RECORDING</b>	
■ Attaching the supplied accessories..	1	<b>AND PLAYING BACK.....</b>	<b>23</b>
◇ Battery pack .....	1	■ About the microSD card.....	23
◇ Antenna.....	1	■ Setting the Record operation .....	24
◇ Hand strap.....	1	■ Recording.....	24
◇ Belt clip.....	1	◇ Starting recording .....	24
■ Charging the battery pack.....	2	◇ Stopping recording .....	24
■ Charging time and the capacity		■ Playing back.....	25
of the battery pack.....	2	■ Removing the MicroSD card.....	26
■ Charging with a USB cable.....	3	◇ Removing when the receiver	
■ Inserting a microSD card .....	4	is OFF.....	26
■ Turning ON the receiver.....	4	◇ Removing when the receiver	
■ Adjusting an audio level.....	4	is ON .....	26
■ Saving a setting data onto			
a microSD card.....	5		
◇ Formatting the microSD card .....	5		
◇ Saving a setting data.....	6		
<b>2 PANEL DESCRIPTION .....</b>	<b>7</b>		
■ Front, top, and side panels .....	7		
■ Keypad.....	8		
■ Function display .....	9		

<b>5 MEMORY CHANNELS .....</b>	<b>27</b>	<b>7 GPS Operation.....</b>	<b>40</b>
■ Selecting a memory channel.....	27	◇ Checking the GPS signal .....	40
■ Viewing the memory channel contents.....	27	■ Checking your GPS location .....	41
■ Writing a new memory channel.....	28	◇ Displaying Position Data .....	41
◇ Writing to a blank channel .....	28	◇ About the GPS POSITION screen.....	41
◇ Writing to a specified channel in a specified group .....	28	■ GPS Logger function.....	42
<b>6 SCANNING .....</b>	<b>29</b>	◇ About the log file.....	42
■ Scan type .....	29	◇ Turning OFF the GPS Logger function.....	42
◇ VFO scan .....	29	<b>8 OTHER FUNCTIONS.....</b>	<b>43</b>
◇ Memory scan.....	29	■ Operating Bluetooth® .....	43
◇ Tone scan .....	29	◇ Electromagnetic Interference .....	43
■ About Scans.....	30	◇ Pairing with a device .....	43
■ Starting or canceling the scan.....	31	◇ Disconnecting a paired device .....	44
■ Convenient function for a Scan.....	31	◇ Unpairing a device.....	45
■ VFO scan .....	32	■ Using the Noise Blanker (NB) .....	45
◇ Full scan (ALL) .....	32	■ Using the Automatic Noise Limiter (ANL).....	45
◇ Band scan (BAND).....	32	■ Using the Automatic Frequency Control (AFC).....	45
◇ Program scan (P00 ~ P49).....	32	■ Using the Voice Squelch Control (VSC).....	45
◇ Program Link scan (P-LINK 0-9) .....	32	■ Using a Weather channel (For only the USA version) .....	46
◇ Auto memory write scan (Auto MW) .....	32	◇ Selecting a Weather channel .....	46
◇ Entering Program Scan ranges .....	33	◇ Receiving a Weather Alert.....	46
◇ About the Program Link Scan .....	34	<b>9 RESET/ TROUBLESHOOTING .....</b>	<b>47</b>
◇ Setting the Program Link function.....	34	■ Resetting.....	47
◇ Storing Skip frequencies .....	35	◇ Partial reset .....	47
◇ Program Skip Scan function.....	35	■ Troubleshooting .....	48
◇ Temporary Skip function.....	35	<b>10 SPECIFICATIONS.....</b>	<b>49</b>
■ Memory scan .....	36		
◇ All scan (ALL).....	36		
◇ Mode scan (MODE).....	36		
◇ Near Station scan (Near Station).....	36		
◇ Group Link scan (GROUP LINK).....	36		
◇ Group scan (GROUP 00 ~ 99) .....	36		
◇ Setting the Group Link.....	37		
◇ Setting the skip channel .....	37		
■ About the Priority Watch function... ..	38		
■ Starting or canceling the Priority Watch function.....	39		
◇ Starting the Priority Watch.....	39		
◇ Canceling the Priority Watch .....	39		
◇ The Priority Watch and Scanning .....	39		

## ■ Attaching the supplied accessories

### ◇ Battery pack

Attach (1) → (2) or detach the battery pack or battery case.

- ① Turn OFF the receiver before attaching or detaching the battery pack.

#### NOTE:

- **BE CAREFUL!** Do not break your finger nail.
- Even when the receiver is OFF, a small current still flows in the receiver. Remove the battery pack or case from the receiver when not using it for a long time. Otherwise, the batteries in the pack or the case will become exhausted.

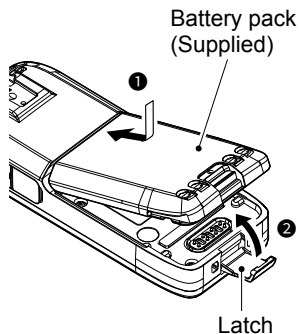

### ◇ Antenna

Connect the supplied antenna to the connector. This receiver has an SMA type antenna connector.

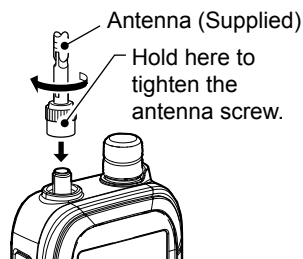

### ◇ Hand strap

- ⚠ **WARNING!** NEVER swing the receiver by holding the hand strap. This can cause injury to yourself or others.

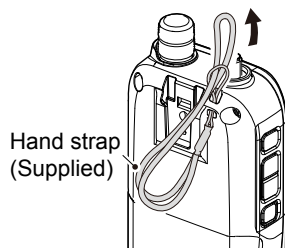

### ◇ Belt clip

To attach the belt clip, slide the belt clip in the direction of the arrow until the belt clip locks in place, and makes a 'click' sound.

To detach the belt clip, lift the tab up (1), and slide the belt clip in the direction of the arrow (2).

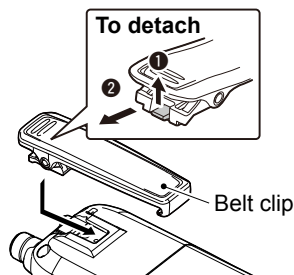

## ■ Charging the battery pack

Prior to using the receiver for the first time, the battery pack must be fully charged for optimum life and operation.

**NOTE:**

- **BE SURE** to turn OFF the receiver before charging the battery pack. Otherwise the attached battery pack cannot be charged completely, or it will take much longer to charge.
- The battery pack becomes hot while charging.
- After the charging is completed, the battery life will be approximately 8.3 hours when the Dualwatch function is ON (A band: continuously receiving, B band: standing by), the Power Save function is set to "Auto (Short)," the internal speaker's volume is set to "20," the GPS function is ON, and the Bluetooth function is OFF.
- Depending on your receiving environment, the receiver may be effected by the switching noise generated from the power adapter. Keep the receiver away from the power adapter.

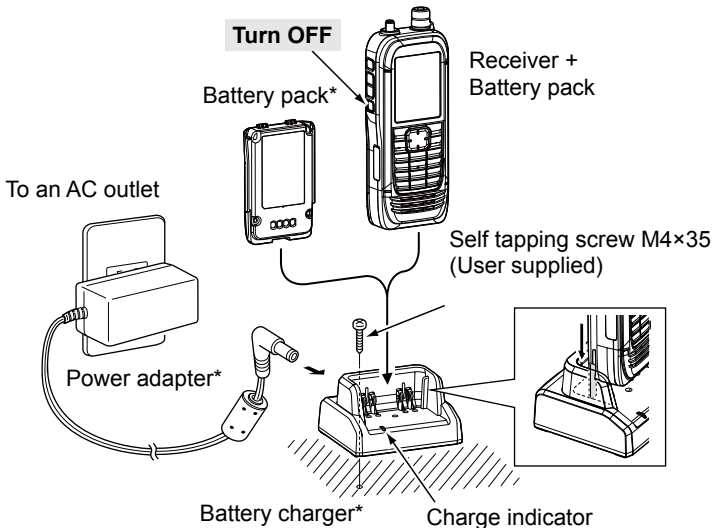

\* May not be supplied, or the shape may be different, depending on the receiver version.

## ■ Charging time and the capacity of the battery pack

Charging time\*: Approximately 4 hours when using the BC-223



The battery has sufficient capacity.



The battery is exhausted a little.



The battery is nearing exhaustion.



**Blinking**

The battery is almost fully exhausted.

\* Depending on your receiving situation.

# 1 PREPARATION

## ■ Charging with a USB cable

You can charge the battery pack with the supplied USB cable (A-microB type).

**NOTE:**

- **BE SURE** to turn OFF the receiver before charging the battery pack. Otherwise the attached battery pack cannot be charged completely, or it will take much longer to charge.
- If you use a third party USB cable, you may not be able to charge:
  - Depending on your USB cable or power adapter.
  - When using a USB hub or connecting to a low output USB port.
- Charging time is approximately 5 hours when using the supplied USB cable and 1 A output USB port, and the temperature is 25°C (77°F).  
Charging time may differ, depending on the USB port.

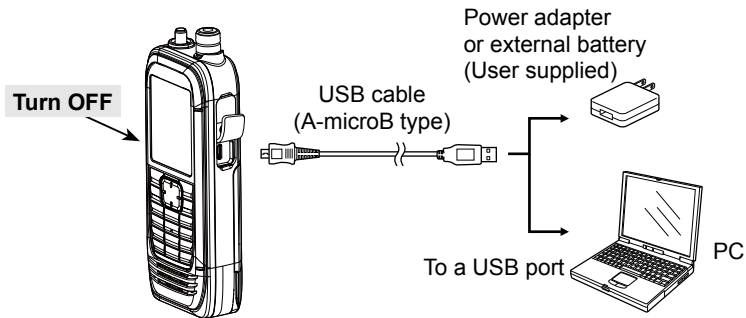



## ■ Inserting a microSD card

Refer to page 23 for the usable microSD card.

1. Turn OFF the receiver.
2. Pull down the [microSD] slot cover on the side panel.
3. With the terminals facing the front, insert the card into the slot until it locks in place and makes a 'click' sound.
  - ① When removing, push in the microSD card until a 'click' sounds. The card is unlocked, and you can pull it out.

**CAUTION:**

- **DO NOT** touch the card terminals.
- **DO NOT** remove the card from the receiver while the card is being accessed. Otherwise, the card data may be corrupted or deleted.

4. Completely close the [microSD] slot cover.

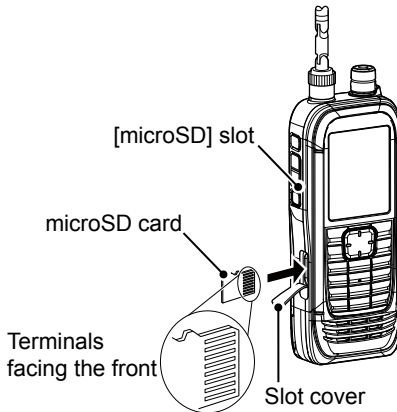

**CAUTION: DO NOT** forcibly or inversely insert the card. It will damage the card or the slot.

## ■ Turning ON the receiver

- Hold down [⏻] for 1 second to turn ON the receiver.
  - After the opening message and the remaining battery capacity are displayed, the receiving frequency is displayed.
- Hold down [⏻] for 1 second again to turn OFF the receiver.

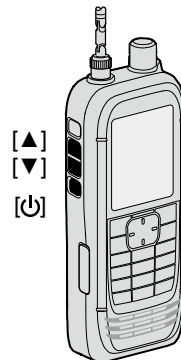

## ■ Adjusting an audio level

- Push [▲] or [▼] to adjust an audio level.
  - ① The display shows the volume level while adjusting.
  - ① Continuously holding down [▲] or [▼] quickly adjusts the level.
  - ① When "VOL" is displayed, the functions assigned to [DIAL] and [▲]/[▼] are swapped. In this case, rotate [DIAL] to adjust the level.

# 1 PREPARATION

## ■ Saving a setting data onto a microSD card

You can save the Memory channels, Menu screen item settings, and GPS memories on a microSD card. Saving settings on a card enables you to easily restore the receiver to its previous settings, even if you perform an All Reset.

### ◇ Formatting the microSD card

**IMPORTANT!** Before using a microSD card, format the card using the receiver.

- ① Formatting a card deletes all its data. Before formatting any used card, back up its data onto your PC.

[MENU] > SD Card > **Format**

1. Turn ON the receiver.
  - ① If a microSD card is inserted, “

The image shows a sequence of four screenshots from a receiver's display, connected by arrows, illustrating the steps to format a microSD card:

    - MAIN screen:** Shows the main interface with frequency 146.010 and 440.000. A small microSD icon is visible in the top right corner.
    - MENU screen:** Shows the menu with "SD Card" selected and highlighted.
    - SD CARD menu:** Shows the "SD CARD" menu with "Format" selected and highlighted.
    - Confirmation dialog:** A dialog box asks "Format OK?" with "YES" and "NO" options. "YES" is selected.

### ◇ Saving a setting data

[MENU] > SD Card > **Save Setting**

1. Push [MENU].
2. Select "Save setting" in the "SD Card" menu.  
(Rotate [DIAL] to select it, and then push [ENTER].)
3. Select "<<New File>>," and then push [ENTER].
  - ① The file name is automatically named in the following manner: Setyyyyymmdd\_xx  
(yyyy: Year, mm: month, dd: day, xx: serial number).
4. Push [ENTER] to set the file name.
  - A confirmation dialog is displayed.
5. Select "YES," and then push [ENTER].
  - While saving, a progress bar is displayed, then returns to the SD CARD screen after the saving is completed.
6. Push [CLEAR] to return to the Main screen.

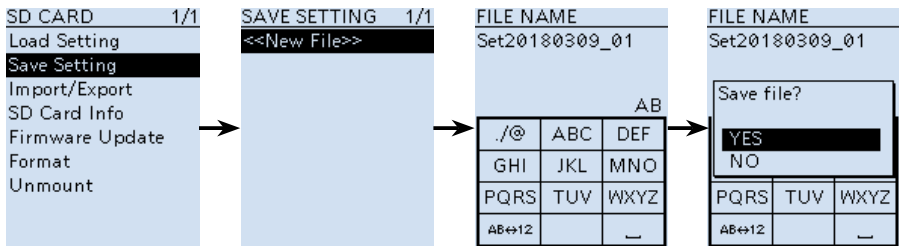

**TIP:** You can edit the saved settings on your PC using the optional CS-R30 CLONING SOFTWARE.

## ■ Front, top, and side panels

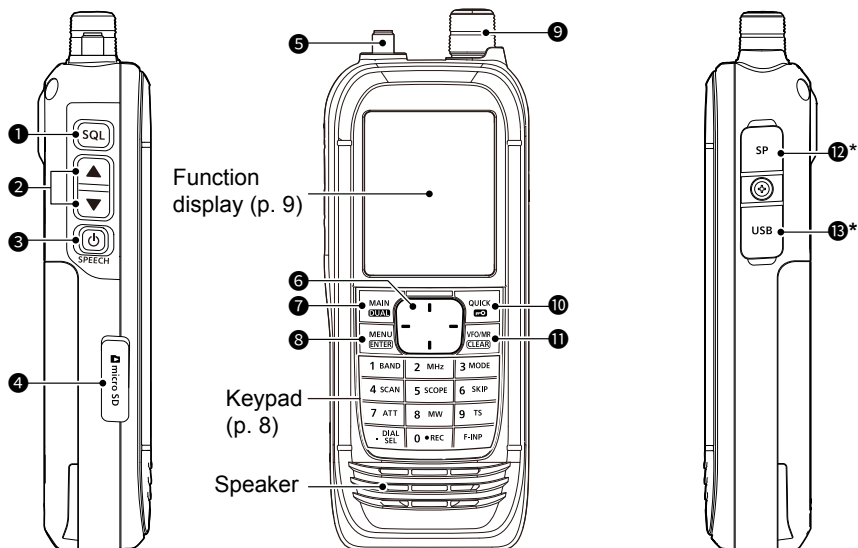

\*Close the cover firmly when no in use.

### 1 SQUELCH ADJUSTMENT KEY [SQL]

- While pushing, rotate [DIAL] to adjust the squelch level. (p. 14)
- Push or hold down to turn the Monitor function ON or OFF. (p. 14)

### 2 VOLUME ADJUSTMENT KEYS [▲][▼]

Push to adjust the audio volume level.

### 3 POWER/SPEECH KEY [⏻]/[SPEECH]

- Push to turn the Speech function ON or OFF. (p. 14)
- Hold down for 1 second to turn the receiver ON or OFF.

### 4 microSD CARD SLOT

Accepts a microSD card (User supplied). (p. 23)

### 5 ANTENNA CONNECTOR

Connect the supplied antenna.

### 6 DIRECTIONAL PAD D-Pad (Up)/D-Pad (Down)/D-Pad (Left)/D-Pad (Right)

Push to select a menu item, setting, and so on. (p. 51)

### 7 MAIN/DUAL KEY [MAIN]/[DUAL] (p. 19)

- Push to set the A or B band as the main band.
- Hold down for 1 second to turn the Dualwatch function ON or OFF.

### 8 MENU/ENTER KEY [MENU]/[ENTER]

- Push to enter the Menu screen.
- Push to set the entered data or selected item.

**9 TUNING DIAL [DIAL]**

Rotate to set the frequency, select a Memory channel, a menu item, or enter characters. (pp. 15, 27 and 51)

**10 QUICK/LOCK KEY [QUICK]/[**

- Push to enter or exit the Quick Menu screen. (p. 13)
- Hold down for 1 second to activate the Key Lock function. (p. 20)

**11 VFO/MEMORY/CLEAR KEY [VFO]/[MR]/[CLEAR]**

- Push to select the VFO mode or Memory mode. (p. 16)
- Push to cancel the entered data, selected item, exit the current mode, or return to the previous screen.

**12 SPEAKER JACK**



Connects to a 3.5 mm (1/8 inch) external speaker plug.

**13 USB (Micro-B) CONNECTOR**

Connects to a PC using the supplied USB cable. (p. 3)

**■ Keypad**

- Push to set the frequency in the VFO mode. (p. 16)
- Push or hold down to use the functions listed below.

KEYS	PUSH	HOLD DOWN
[1]/[BAND]	Selects a band in the VFO mode, or selects a group in the Memory mode.	
[2]/[MHz]	Turns the MHz tuning mode ON or OFF (VFO Mode).	
[3]/[MODE]	Displays the Receive mode options.	
[4]/[SCAN]	Displays the Scan type options.	Starts the last selected scan.
[5]/[SCOPE]	Displays the Sweep type options.	
[6]/[SKIP]	Displays the Skip/Program Skip options (in the Memory mode).	
[7]/[ATT]	Displays the Attenuator options.	
[8]/[MW]	Displays the Memory Write options.	Writes memory to the selected channel.
[9]/[TS]	Displays the Tuning step options.	
[.]/[DIAL SEL]	Changes the functions assigned to [DIAL] and [  ]/[  ].	
[0]/[  REC]	Starts or stops the voice recording.	
[F-INP]	Displays the Frequency Setting screen.	

## 2 PANEL DESCRIPTION

### ■ Function display

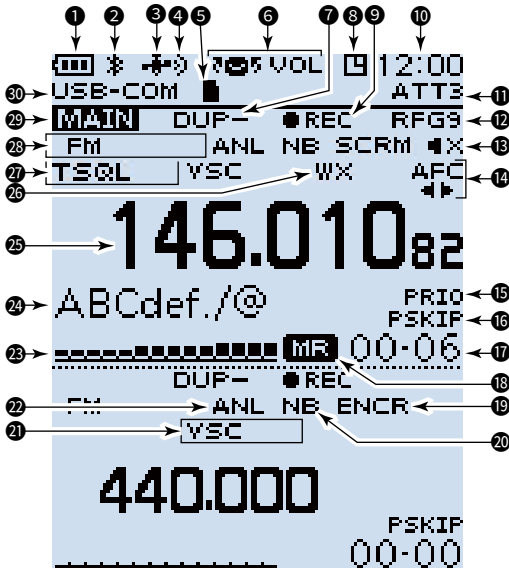

Dual band display (Dualwatch function is ON)

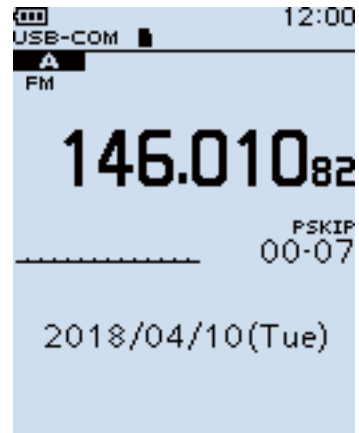

Single band display  
(Dualwatch function is OFF)

(These screens are only examples.)

#### ① BATTERY INDICATOR

Displays the battery status. (p. 2)

#### ② Bluetooth® ICON

Displayed when a Bluetooth device is connected. (p. 43)

#### ③ GPS ICON

Displays satellite acquisition status. (p. 40)

#### ④ GPS ALARM ICON

Blinks when the GPS Alarm sounds. See ADVANCED MANUAL for details.

#### ⑤ microSD CARD ICON (p. 23)

- Displayed when a microSD card is inserted.
- Blinks while the receiver is accessing a microSD card.

#### ⑥ VOLUME/DIAL SWITCH ICON

Displayed when the Volume Adjustment function is assigned to [DIAL].

- ① “SQL” is displayed while adjusting the squelch.

#### ⑦ DUPLEX INDICATOR

- “DUP+”: Displayed when Plus duplex is selected.
- “DUP- ”: Displayed when Minus duplex is selected.

#### ⑧ AUTO POWER OFF ICON

Displayed when the Auto Power OFF function is ON.

#### ⑨ RECORD ICON (p. 24)

- “■”: Displayed when recording.
- “|||”: Displayed when recording is paused.

#### ⑩ CLOCK READOUT

Displays the current time.

#### ⑪ ATTENUATOR INDICATOR

Displayed when attenuator “ATT1” ~ “ATT3” is ON.

#### ⑫ RF GAIN INDICATOR

Displayed when the RF gain is set to other than “RFG MAX” to indicate that the RF gain is reduced.

**13 MUTE ICON**

Displayed when the sub band audio signal is muted, depending on the receive band or mode. (p. 19)

**14 AFC ICON**

Displayed when the Automatic Frequency Control function is ON. (p. 45)

**15 PRIORITY ICON**

Displayed during a Priority watch. (p. 38)

**16 SKIP INDICATOR (p. 37)**

- “SKIP”: Displayed when Memory Skip is set.
- “PSKIP”: Displayed when Program Skip is set.

**17 MEMORY CHANNEL READOUT**

Displays the selected memory channel number.

**18 MEMORY MODE ICON**

Displayed when the Memory mode is selected. (p. 16)

**19 SCRAMBLER/ENCRYPTION INDICATOR**

- “SCRM”: Displayed when the Descrambler function is ON.
- “ENCR”: The Decryption function is ON.

**20 NOISE BLANKER ICON**

Displayed when the Noise Blanker function is ON. (p. 45)

**21 VSC INDICATOR**

Displayed when the Voice Squelch Control function is ON. (p. 45)

**22 AUTOMATIC NOISE LIMITER ICON**

Displayed when the Automatic Noise Limiter function is ON. (p. 45)

**23 S-METER**

Displays the relative signal strength of the receive signal.

**24 MEMORY NAME READOUT**

Displays the memory name, if entered.

**25 FREQUENCY READOUT**

Displays a variety of information, such as the frequency or menu contents.

**26 WX INDICATOR**

**(For only the USA version.)**

Displayed when the Weather Alert function is ON.

**27 TONE/DIGITAL SQUELCH INDICATOR**

Displayed when a Tone/Digital squelch function is ON.

- TSQL: Tone Squelch.
- DTCS: DTCS Squelch.
- TSQL-R: Reverse Tone Squelch.
- DTCS-R: Reverse DTCS Squelch.
- CSQ: Digital Code Squelch. (D-STAR)
- NAC: Network Access Code (P25)
- COM ID: Common ID (dPMR)
- CC: CC (dPMR)
- RAN: Radio Access Number (NXDN-VN/NXDN-N)
- UC: User Code (DCR)

**28 MODE INDICATOR**

Displays the selected receive mode.

**29 MAIN BAND ICON**

- When the Dualwatch function is ON, indicates that the selected band (A or B) is the Main band.
- When the Dualwatch function is OFF, indicates the selected band (A or B).

**30 USB CONNECTION INDICATOR**

Displayed when a PC is connected through a USB cable, and “Serialport” is selected in the Menu screen.

([MENU] > Function > USB Connect > **Serialport**)

## ■ MENU screen

The MENU screen is displayed after pushing [MENU].

You can use the MENU screen to change settings.

See the appendix for the MENU item list. (p. 51)

For details of each item, see ADVANCED MANUAL.

### MENU screen structure

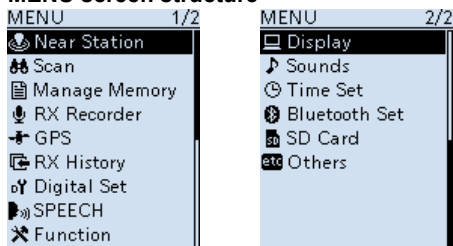

**TIP:** The MENU screen is constructed in a tree structure. You may go to the next tree level, or go back a level, depending on the selected item.

## ◇ MENU screen operation

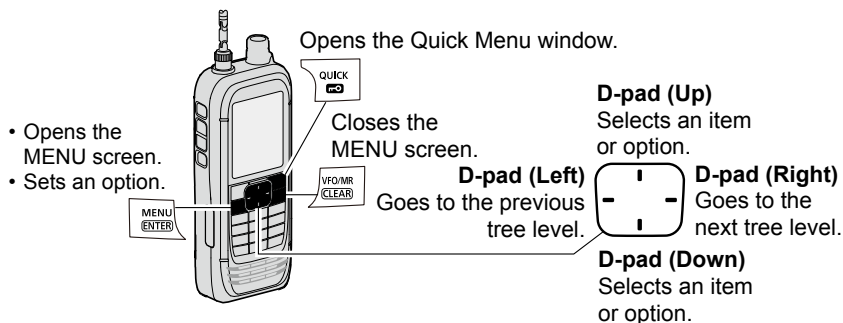

### Simplified description—'Select' operation

In this manual, user's 'Select' operation is simplified, as described below.

**Simplified description:** Select "Function," and then push [ENTER].

**Operation:** Push D-pad (Up) or (Down) to select "Function," and then push [ENTER].



## ◇ Selecting a Menu item

Example: Set “Auto Power OFF” to “30 min.”

[MENU] > Function > **Auto Power OFF**

1. Push [MENU].
2. Select “Auto Power OFF” in the “Function” menu.  
(Rotate [DIAL] to select it, and then push [ENTER].)
3. Select “30min,” and then push [ENTER].  
• Sets the option, then goes back to the previous tree level.
4. Push [CLEAR] to return to the Main screen.

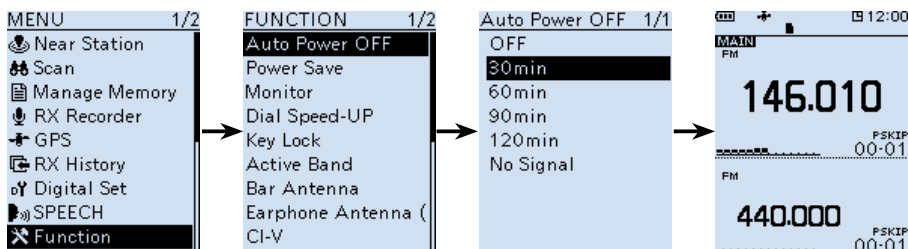

### TIP: To return to the default setting

1. Push [QUICK] in step 3.
2. Select “Default,” and then push [ENTER].  
• The setting returns to the default.

① The default settings of each item are described in ADVANCED MANUAL.

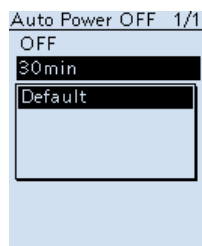

### 3 BASIC OPERATION

#### ■ Quick Menu window

You can open the Quick Menu window by pushing [QUICK]. Selectable items in the window may differ, depending on the selected mode or function. The items listed below are two examples.

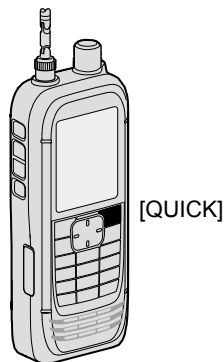

#### Selectable items in the VFO mode and Memory mode

VFO mode		Memory mode	
Band Select	NB*6	Group Select	ANL*7
MODE	ANL*7	MODE	AFC*8
DUP	AFC*8	DUP	SKIP
TONE*1	GPS Information	TONE*1	GPS Information
VSC*2	GPS Position	VSC*2	GPS Position
D.SQL*3	PRIQ Watch	D.SQL*3	Home CH Set
SCRAM*4	Home CH Set	SCRAM*4	Display Type
ENCR*5	Battery Level	ENCR*5	Battery Level
TS	Band Scope	TS	Band Scope
ATT	<<REC Start>>	ATT	<<REC Start>>
RF Gain	<<GPS Logger Only>>	RF Gain	<<GPS Logger Only>>
—	—	NB*6	—

\*1 For only FM/FM-N

\*2 For only FM/FM-N/WFM/AM/AM-N

\*3 For only D-STAR/P25/dPMR/NXDN-VN/NXDN-N/DCR  
(Selectable options differ, depending on the receiving mode.)

\*4 For only dPMR

\*5 For only NXDN-VN/NXDN-N/DCR  
(Selectable options differ, depending on the receiving mode.)

\*6 For only USB/LSB/CW

\*7 For only AM

\*8 For only FM/FM-N/WFM

## ■ Setting the squelch level

Noise squelch enables the audio to be heard only while receiving a signal that is stronger than the set level. A higher level blocks weak signals, which enables you to receive only stronger signals. A lower level enables you to hear weak signals.

① “Noise squelch” is abbreviated to “Squelch” in this manual.

While holding down [SQL], rotate [DIAL] to select the squelch level.

- “**SQL**” is displayed.

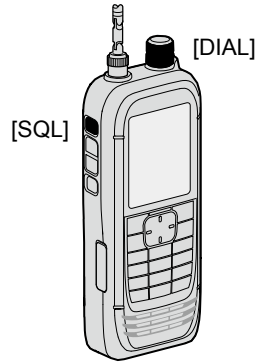

3

### ① Information

- Options: “OPEN,” “AUTO” (default), and “LEVEL 1” ~ “LEVEL 9”
- “LEVEL 1” is loose squelch (for weak signals) and “LEVEL 9” is tight squelch (for strong signals).
- “AUTO” is an automatic level adjustment using a noise pulse counting system.
- “OPEN” is the continuously open setting.
- This option is not selectable in the Digital (D-STAR, P25, dPMR, NXDN-VN, NXDN-N, or DCR) mode.

## ■ Monitor function

The Monitor function is used to listen to weak signals without changing the squelch setting.

While holding down [SQL], the receiver monitors weak signals on the frequency.

**TIP:** You can set the Monitor Hold function on the MENU screen. The receiver opens or closes the squelch each time you push [SQL].  
 ([MENU] > Function > **Monitor**)

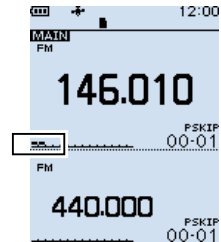

The first few segments of the S-meter blinks.

## ■ Speech function

The Speech function audibly announces the displayed frequency and mode by pushing [SPEECH].

Also, you can set various Speech functions, such as the DIAL Speech function or Mode Speech function on the MENU screen.

- ([MENU] > SPEECH > **DIAL SPEECH**)
- ([MENU] > SPEECH > **MODE SPEECH**)

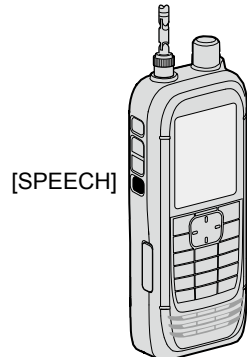

## 3 BASIC OPERATION

### ■ Setting the frequency

#### ◇ Directly entering a frequency

You can set the frequency with the keypad.

1. Push [VFO/MR] to select the VFO mode.
2. Push [F-INP].
3. Start entry with the MHz digits.
  - When you finish entering the 1 kHz digit, a beep sounds and the entered frequency is set.

#### ① Information

- If you want to change the digits from 100 kHz or below, enter [.] and then enter the digits.
- If you push [ENT] when the digits from 100 kHz or below are not entered, "0" is automatically entered into the blank digits.  
(Example: [1], [4], [5], [ENTER] → 145.000 (MHz))
- If you enter a frequency out of range, an error beep sounds.
- Settable receiving bands differ on the A band and B band. (p. 17)

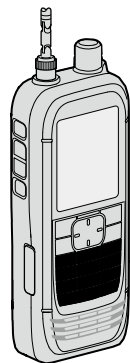

Keypad

#### ◇ Changing the frequency in MHz steps

You can change the frequency in 'MHz' steps for quick tuning.

1. Push [VFO/MR] to select the VFO mode.
2. Push [MHz].
  - The 1 MHz digit blinks.
3. Rotate [DIAL].
  - The frequency changes in 1 MHz steps.
4. Push [MHz].
  - Sets the frequency, and then returns to the Main screen.

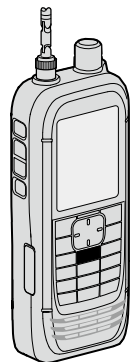

[MHz]

◇ **Selecting the tuning step**

When you select the frequency by rotating [DIAL] in the VFO mode, it changes in the selected tuning step.

1. Push [VFO/MR] to select the VFO mode.
2. Push [TS].
3. Select a tuning step.  
(Rotate [DIAL] to select it, and then push [ENTER].)
4. Push [TS].
  - Returns to the Main screen.

\*1 For only the AIR band.

\*2 For only the BC band.

0.01 kHz	12.5 kHz
0.1 kHz	15.0 kHz
1.0 kHz	20.0 kHz
3.125 kHz	25.0 kHz
5.0 kHz	30.0 kHz
6.25 kHz	50.0 kHz
8.33kHz*1	100.0 kHz
9.0kHz*2	125.0 kHz
10.0 kHz	200.0 kHz

■ **Selecting the Frequency Selecting mode**

This receiver has 2 Frequency Selecting modes. You can change modes by pushing [VFO/MR].

◇ **Variable Frequency Oscillator (VFO) mode**

You can set the frequency by rotating [DIAL], or by directly entering it with the keypad.

◇ **Memory mode**

You can set the frequency by selecting a preset channel, using [DIAL] or keypad.

- ① In the Memory mode, "MR" and Memory Channel number are displayed.

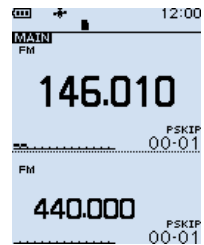

VFO mode display

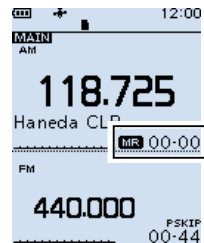

Memory mode display

### 3 BASIC OPERATION

#### ■ Selecting the receive mode

1. Push [MODE].
  - The Receive Mode options are displayed.
2. Select the Receive mode.
  - The selected mode is displayed.

**NOTE:**

Selectable receive mode differs, depending on the band.

- A band (1300 MHz and below): All modes\*.
- A band (1300 MHz or higher): FM/FM-N/WFM/AM/AM-N.
- B band: FM/FM-N/AM/AM-N/Digital modes.

\*"WFM" is not selectable, depending on the receiver version and receive frequency.

FM	Analog mode
FM-N	
WFM	
AM	
AM-N	
LSB	
USB	
CW	
CW-R	
D-STAR	Digital mode
P25	
dPMR	
NXDN-VN	
NXDN-N	
DCR	

#### ■ Selecting the receive band

1. Push [VFO/MR] to select the VFO mode.
2. Push [BAND].
  - The Receive Band options are displayed.
  - The frequency set last time is displayed.
3. Select the Receive band.
  - The selected band is displayed.

Default display	Band name
1.620	BC band
5.000	5 MHz band
51.000	51 MHz band
88.000	FM band
120.000	AIR band
146.010	146 MHz band
370.000	370 MHz band
440.000	440 MHz band
850.000	850 MHz band
1295.000	1200 MHz band
2425.000	2400 MHz band

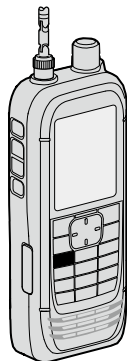

[BAND]

- ① On the B band, you can select only AIR, 146 MHz, 370 MHz, and 440 MHz bands.

## ■ DIAL/VOL Switch function

You can switch the functions assigned to [DIAL] and [▲]/[▼].

- Push [DIAL SEL] to switch the functions assigned to [DIAL] and [▲]/[▼].

### ① Information

- “VOL” is displayed when the Volume Adjustment function is assigned to [DIAL].
- Push [DIAL SEL] again to return to the previous setting.
- Even if the Volume Adjustment function is assigned to [DIAL], you can set a squelch level by using [DIAL].
- In this manual, all instructions are described without this setting.

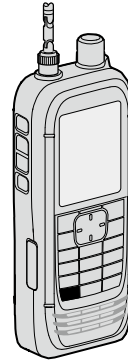

[DIAL SEL]

3

## ■ Setting the RF gain

Set the sensitivity level to receive. Normally, set the RF gain to maximum (“RFG MAX”).

1. Push [QUICK].
2. Select “RF Gain,” and then push [ENTER].
3. Select the level.
  - ① Options: “RFG1” ~ “RFG9” and “RFG MAX” (default)
  - ① When “RFG MAX” is selected, nothing is displayed.

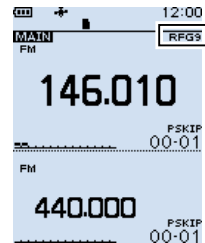

## ■ Attenuator

The Attenuator prevents a desired signal from becoming distorted when a very strong signal is near the frequency, or when near a very strong electric field.

1. Push [ATT].
  - The Attenuator options are displayed.
2. Set the Attenuator level to between “ATT1” to “ATT3.”
  - ① The higher the level, the larger the attenuation amount becomes.

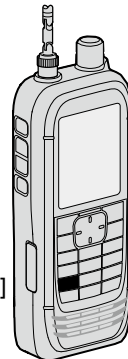

[ATT]

### 3 BASIC OPERATION

#### ■ Dualwatch function

Dualwatch function simultaneously monitors two frequencies. The IC-R30 has 2 independent receiver circuits, A band and B band. You can set different frequencies or receive modes in each band.

- ① In the A band, you can select any frequency. In the B band, you can select only the AIR, 146 M, 370 M, or 440 M frequency bands.
- ① When the Dualwatch function is ON, the audio output may be interrupted when the frequency is switched while scanning, or by other factors.

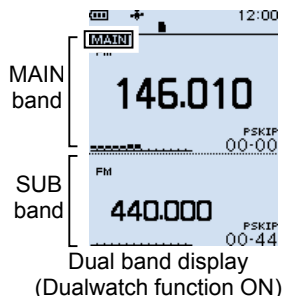

#### ◇ Turning Dualwatch function ON or OFF

Hold down [DUAL] for 1 second to turn the Dualwatch function ON or OFF.

##### ① Information

- When the Dualwatch function is ON, the display shows the A band in the upper half and the B band in the lower half.
- “MAIN” is displayed on the MAIN band where you can change the settings.
- When the Dualwatch function is OFF, the display shows only the MAIN band. Push [MAIN] to select A or B band.
- The SUB band can be automatically muted.
- ([MENU] > Sounds > **Sub Band Mute (Main RX)**)

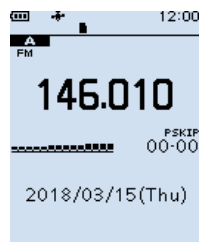

Single band display (Dualwatch function OFF)

**TIP:** Depending on the receive mode, the SUB band audio signal is muted. In such case, “” is displayed.

##### • SUB band mute status

MAIN band	SUB band
LSB/USB	Digital modes*
CW/CW-R	
Digital modes*	

\*Except when D-STAR is selected on the Dualwatch screen.

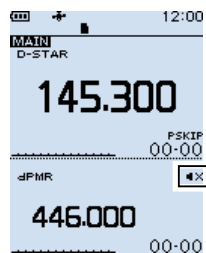



### ◇ Selecting the MAIN band

Push [MAIN] to alternately set the upper band or lower band to the MAIN band.

- "MAIN" is displayed on the MAIN band where you can change the settings.
- ① Band selection, receive frequency setting, receive mode selection, Memory channel selection, the Memory Write operation, the Band Scope operation can be made on only the MAIN band.

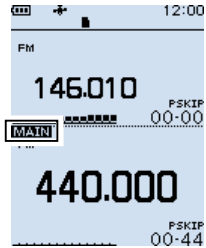

B band is set to the MAIN band

### ◇ Setting the volume for Dualwatch

The volume setting for Dualwatch can be separately set for each band on the MENU screen.

[MENU] > Sounds > **A/B Vol Link**

1. Push [MENU].
2. Select "A/B Vol Link," in the "Sounds" menu. (Rotate [DIAL] to select it, and then push [ENTER].)
3. Select "A/B Separate," and then push [ENTER].
  - ① Push [CLEAR] to return to the Main screen.

## ■ Key Lock function

Activate to prevent accidental frequency changes and unnecessary function access.

- Hold down [M-O] for 1 second to turn ON the Key Lock function.
- When the Key Lock function is ON and the locked key or [DIAL] is pushed or rotated, "LOCK ON" is displayed.

#### ① Information

- To turn OFF the function, hold down [LOCK] for 1 second again (Until "LOCK OFF" is displayed).
- [P], [M-O], [SQL], and [▲]/[▼] (volume adjustment) can be used even if the Key Lock function is ON.
- You can change the keys to be locked on the MENU screen. ([MENU] > Functions > **Key Lock**)

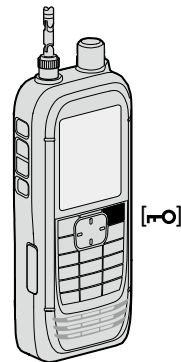

### 3 BASIC OPERATION

#### ■ Band Scope function

Use the Band Scope function to visually search for a specified frequency range around the displayed frequency. You can use this function to search for a signal, and see the relative received signal strength level.

The Band Scope function has 2 sweep types.

- Single Sweep: Searches the specified frequency range only once. The Single Sweep starts from the lower frequency and the sweep stops after reaching to the upper frequency.
- Continuous Sweep: Repeatedly searches the specified frequency range.

The receiver's sweep bandwidth is  $\pm 15 \times$  the tuning step number, centered on the displayed frequency.

① The  $\pm 15$  times is a fixed value.

#### Example:

The displayed frequency is 146.000 MHz and the tuning step is set to 5 kHz. Therefore, the sweep range is between 145.925 MHz (lower edge frequency) and 146.075 MHz (higher edge frequency).

See the calculation below.

$$\begin{aligned} \text{Lower edge frequency} &= -15 \times 5 \text{ kHz} \\ &= -75 \text{ kHz } (-0.075 \text{ MHz}) \\ \text{Higher edge frequency} &= +15 \times 5 \text{ kHz} \\ &= +75 \text{ kHz } (+0.075 \text{ MHz}) \end{aligned}$$

- The displayed (center) frequency is 146.000 MHz
- The lower (start) frequency is 145.925 MHz  
(= 146.000 MHz - 0.075 MHz)
- The higher (stop) frequency is 146.075 MHz  
(= 146.000 MHz + 0.075 MHz)

**Example:** A strong signal is received on 146.025 MHz.  
(Tuning step: 5 kHz)

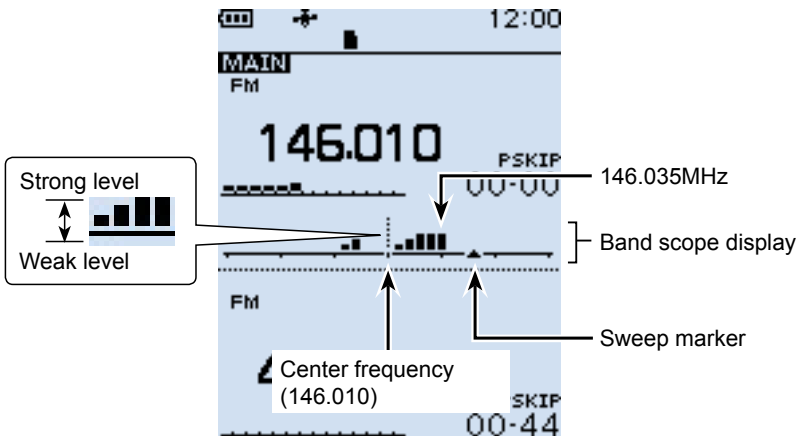

◇ Sweep operation

Example: Continuous sweeps centered on 146.010 MHz

1. Push [VFO/MR] to select the VFO mode.
2. Rotate [DIAL] to set 146.010 MHz.
3. Push [SCOPE].
4. Select "Continuous Sweep."  
(Rotate [DIAL] to select, and then push [ENTER].)  
• Returns to the frequency display and starts the continuous sweep.
5. Push [CLEAR].  
• Stops the sweep.
6. Rotate [DIAL] to move the sweep marker to a detected signal.  
• You can hear the signal audio.  
① Pushing [SCOPE] and then selecting "Center Recall" returns the sweep marker to the center frequency.
7. Push [SCOPE].
8. Select "Scope OFF," and then push [ENTER].  
• Turns OFF the Band Scope function.

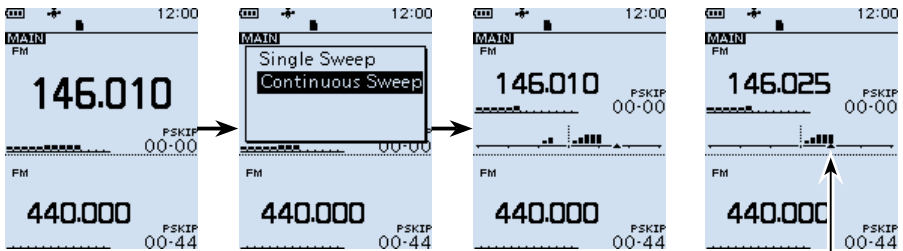
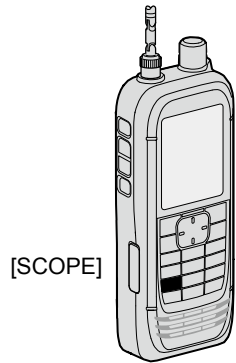

Sweeping

After stopping the sweep, move the marker to a detected signal.

**TIP:**

- If the tuning step is set too wide, the signals in the sweep range may not be displayed (they may be skipped), even if they are strong signals. Therefore, we recommend that you set the tuning step to 20 kHz or less to use the Band Scope function.
- During a sweep the frequency range of 108.000 ~ 520.000 MHz, the displayed frequency's audio is output. (When the receive mode is set to WFM, LSB, USB, CW or CW-R, the audio is not output.)  
You can turn OFF the audio output on the MENU screen.  
([MENU] > Sounds > **Scope AF Output**)

## ■ About the microSD card

The microSD and microSDHC cards are not supplied by Icom. User supplied.

You can use a microSD card of up to 2 GB, or an microSDHC card of up to 32 GB. Icom has checked the compatibility with the following microSD and microSDHC cards.

(As of April 2018)

Brand	Type	Memory size
SanDisk®	microSD	2 GB
	microSDHC	4 GB
		8 GB
		16 GB
		32 GB

- ① The performance of the cards listed above is not guaranteed.
- ① Throughout the rest of this document, the microSD card and an microSDHC card are simply called the microSD card or the card.
- ① If you use a brand new microSD card, be sure to format it. (p. 5)

### NOTE:

- Before using the microSD card, thoroughly read the card's instructions.
- Before removing the microSD card while the receiver's power is ON, do the removal procedure. (p. 26)
- If any of the following occurs while the card is being accessed, the card data may be corrupted or deleted.
  - You remove the microSD card from the receiver.
  - You remove the battery pack or case.
  - The battery is exhausted.
  - The power supply from an external power source is disconnected.
- Do not touch the contacts of the card.
- The receiver takes a longer time to recognize a large capacity card.
- The card will get warm if continuously used for a long period of time.
- The card has a certain lifetime, so data reading or writing may not be possible after using it for a long period of time. When reading or writing data is impossible, the card's lifetime has ended. In that case, use a new one.
 

We recommend you make a separate backup file of the important data onto your PC.
- Icom is not be responsible for any damage caused by data corruption of a card.

## ■ Setting the Record operation

You can select to record the received audio from only the main band or both the main and sub bands.

[MENU] > RX Recorder > Recorder Set > **REC Operation**

1. Push [MENU].
2. Select "REC Operation" in the "RX Recorder" menu.  
(Rotate [DIAL] to select it, and then push [ENTER].)
3. Select "A/B Separate" or "A/B Link." (default: A/B Link)  
 "A/B Separate": Only audio signal received on the band that is set as MAIN (A or B) is recorded.  
 "A/B Link": Audio signals received on either or both MAIN and SUB band (Both A and B) are recorded.  
 ① Push [CLEAR] to return to the Main screen.

## ■ Recording

### ◇ Starting recording

- Push [●REC].
  - "Recording started..." is briefly displayed.

#### TIP:

- "●REC" is displayed during recording.
- "■REC" is displayed while recording is paused.
- If a single band display is selected, only the audio signal received on the band is recorded, even when the "REC Operation" item is set to "A/B Link."
- The recording continues until you push [●REC], or the free space on the microSD card has run out.
- When the recording file's content reaches 2 GB, the receiver continues to record, but to a new file.

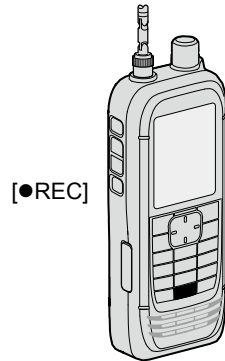

### ◇ Stopping recording

1. Push [●REC] again.
  - A confirmation dialog is displayed.
2. Select "YES," and then push [ENTER].
  - "Recording stopped." is briefly displayed.

**NOTE:** Once the recording starts, it will continue even if the receiver is turned OFF and ON again.

#### TIP:

As the default setting, the recording is paused while the squelch is closed, and resumes when a signal is received. But you can set to continue recording even while no signal is received. (See section 6 of the ADVANCED MANUAL.)

([MENU] > RX Recorder > Recorder Set > **RX REC Condition**)

## 4 RECORDING AND PLAYING BACK

### ■ Playing back

[MENU] > RX Recorder > **Play Files**

1. Push [MENU].
2. Select "Play Files" in the "RX Recorder" menu.  
(Rotate [DIAL] to select it, and then push [ENTER].)
  - The folder list is displayed.
3. Select a folder that contains the file you want to playback, and then push [ENTER].
  - The file list is displayed.
  - ① The folder is named in the following manner, "yyymmdd (yyyy: Year, mm: month, dd: day).
4. Select a file, and then push [ENTER].
  - The VOICE PLAYER screen appears and starts playing back the audio.
  - ① Push [ENTER] to pause while playing.
  - ① On the VOICE PLAYER screen, you can select the file to play by pushing D-pad (Up) or (Down).
5. Push [CLEAR] to stop playing.
  - The file list is displayed.
  - ① Push [CLEAR] again to return to the Main screen.

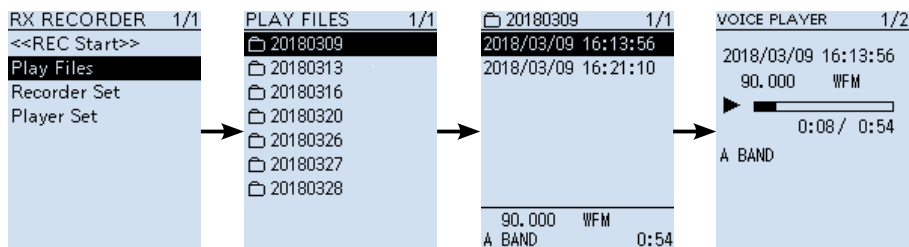

## ■ Removing the MicroSD card

### ◇ Removing when the receiver is OFF

1. Turn OFF the receiver.
  2. Pull down the [microSD] card slot cover.
  3. Push in the microSD card into the slot until a click sounds.
    - The card is unlocked, and you can pull it out.
- ① Do not touch the contacts of the card.

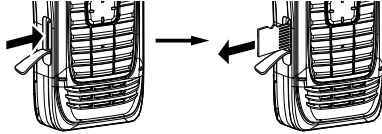

4. Close the [microSD] card slot cover.

### ◇ Removing when the receiver is ON

[MENU] > SD card > **Unmount**

1. Push [MENU].
2. Select "Unmount" in the "SD Card" menu.  
(Rotate [DIAL] to select it, and then push [ENTER].)
  - The unmount confirmation dialog appears.
3. Select "YES," and then push [ENTER].
  - "Unmount is completed." is displayed.
4. Push in the microSD card until a click sounds, then pull it out. (See the above illustration.)
  - ① Push [CLEAR] to return to the Main screen.

**NOTE:** Close the microSD card slot cover firmly, after removing or inserting microSD card. Otherwise dust or water may get into the receiver, and they can damage the receiver.

Close the slot cover firmly

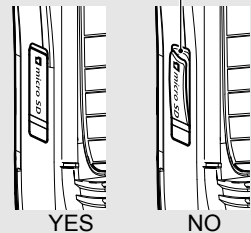

## ■ Selecting a memory channel

Rotate [DIAL] in the Memory mode to select a Memory channel.

- ① The memory contents on the screen may differ, according to the presetting.
1. Push [VFO/MR] to select the Memory mode.
  - ① Each push toggles between the Memory mode and the VFO mode.
  - ① Push [BAND] to display the Memory Group list, if necessary to select a group.
2. Rotate [DIAL] to select a Memory channel.
  - ① Only the Memory channels that have contents are displayed.
  - ① To select the Memory channel from the keypad, push [F-INP] then enter the Memory channel number.

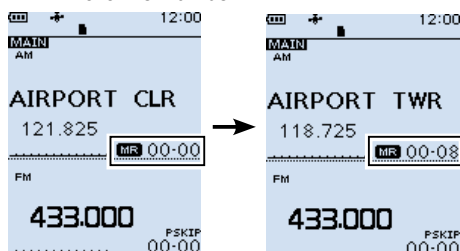

## ■ Viewing the memory channel contents

You can view the Memory channel contents on the [Manage Memory] screen.

[MENU] > Manage Memory > **Memory Channel**

Example: Viewing the contents of **Channel 8 in Group 00**.

1. Push [MENU].
2. Select "Manage Memory."  
(Rotate [DIAL] to select it, and then push [ENTER].)
3. Select Memory Channel Group "00," and then push [ENTER].
4. Select Memory Channel "08," and then push [ENTER].
  - Channel contents are displayed.
  - ① Rotate [DIAL] to scroll the screen.
  - ① Push [CLEAR] to return to the Main screen.

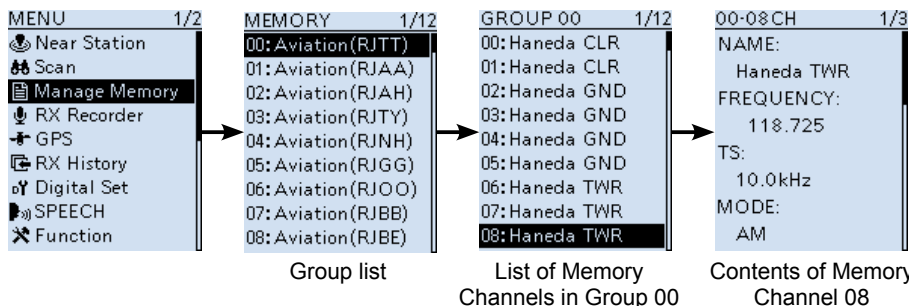



## ■ Writing a new memory channel

A single memory channel stores the frequency, receive mode and so on, for quick recall.

The following is the basic memory writing procedure.

① Refer to ADVANCED MANUAL for memory writing details.

② See Section 3 for the receive frequency or receiving mode setting procedures.

### ◇ Writing to a blank channel

Example: Writing “145.000 MHz” in the “FM” mode to a blank channel in a selected group.

- Hold down [MW] until 2 beeps sound.
  - The contents such as frequency and operating mode are briefly displayed, then written to a blank channel (45) in the selected group (00).

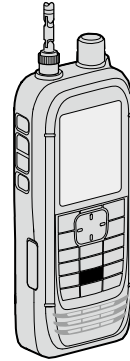

5

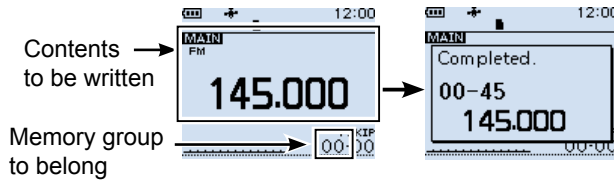

### ◇ Writing to a specified channel in a specified group

Example: Writing “145.100 MHz” in the “FM” mode into channel 01 in group 55.

1. Push [MW].
2. Select “Write to New CH.”  
(Rotate [DIAL] to select it, and then push [ENTER].)
3. Push [QUICK].
4. Select “Group Select,” and then push [ENTER].
5. Select group “55,” and then push [ENTER].
6. Rotate [DIAL] to select channel “01.”
  - The selected channel blinks.
7. Push [MW].
  - The writing confirmation dialog appears.
8. Select “YES.”
  - The contents to be written into the channel are briefly displayed, then are written into channel “01” in group “55.”

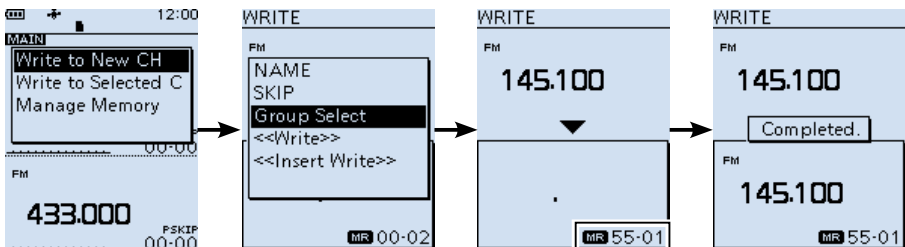

## ■ Scan type

Scanning is a versatile function that can automatically search for signals. A scan makes it easier to locate stations to listen to, or to skip unwanted channels or frequencies.

### ◇ VFO scan (p. 32)

In the VFO mode, the VFO scan searches a signal within the specified frequency range.

Scan type	Description
Auto MW	When a signal is received during a VFO scan, the frequency is automatically stored into an Auto Memory Write channel group (A000 ~ A199).
ALL	Repeatedly scans the entire frequency range.
BAND	Repeatedly scans the selected band.
P-LINK 0 ~ 9	Sequentially scans several Program Scan ranges. The links are set on the MENU screen. ([MENU] > Scan > <b>Program Link</b> )
P00 ~ 49	Repeatedly scans the Program Scan range. The scan edges are set on the Menu screen. ([MENU] > Scan > <b>P-Scan Edge</b> )

### ◇ Memory scan (p. 36)

In the memory mode, the memory scan searches a signal on the preregistered memory channels.

Scan type	Description
ALL	Scans all Memory channels.
Mode	Scans Memory channels which are entered with the same receiving mode as the currently selected mode.
Near Station	Searches for near stations that are within 160 kilometer (100 miles) from your location using your GPS position and the station's position that is entered in the memory channels.
GROUP LINK	Sequentially scans the memory groups which are set to link on the MENU screen.
GROUP	Scans the Memory channels in the selected group. (GROUP 00 ~ 99, A: Auto MW CH, S: SKIP CH)

### ◇ Tone scan

The Tone scan searches for signals in tone frequencies or DTCS codes that are used by stations using the Tone Squelch function.

See **ADVANCED MANUAL** for its operation.

① A Tone scan is usable in either VFO or Memory channel mode.

① During a scan, rotate [DIAL] to change the scan direction.

See "Tone squelch operation" or "DTCS code squelch operation" for details on **ADVANCED MANUAL**.

## ■ About Scans

### ○ [DIAL] operation during a scan

- Rotate [DIAL] to change the scan direction during a scan.
- When the scan is paused, rotate [DIAL] to resume the scan.

### ○ Squelch setting for a scan

You can change the squelch level to suit your operating needs. Set the squelch level to open the squelch, according to the received signal strength.

- ① During a scan, rotate [DIAL] while holding down [SQL] to adjust the squelch level. The scan resumes after adjusting.

### ○ Tuning step for a VFO scan

The selected tuning step is applied to the scan.

For a Program scan or Program Link scan, set the tuning step in the Program Scan ranges (P-Scan Edge).

### ○ Scan Skip function\*

The skip function speeds up scanning by not scanning those frequencies set as skip channels.

#### In the VFO mode

The frequencies that are set as "PSKIP" are skipped during a scan. (p. 37)

#### In the Memory mode

The frequencies that are set as skip channels "PSKIP" and "SKIP" are not scanned. (p. 37)

- ① You must enter 2 or more Memory channels to start a memory scan.

**TIP:** When **Program Skip** is set to OFF, you cannot use the Program Skip scan function. (p. 35)  
([MENU] > Scan > **Program Skip**)

### ○ Receiving mode during a scan

- The VFO scan uses the selected receiving mode.
- During a Memory mode scan, the receiving mode entered into the channel is used.

### ○ When signal is received

When a signal is received, the scan pauses for this set period of time.

When a received signal disappears, the scan resumes for this set period of time.

[MENU] > Scan > **Pause Timer**

[MENU] > Scan > **Resume Timer**

1. Push [MENU].
2. Select "Pause Timer" or "Resume Timer" in the "Scan" menu.
3. Select an option, and then push [ENTER].

#### Pause Timer\*

- 2 ~ 20 sec:  
When a signal is received, the scan pauses for 2 ~ 20 seconds (in 2 second steps).
- HOLD: The scan pauses on a received signal until the signal disappears.

#### Resume Timer\*

- 0 sec: The scan resumes immediately after the signal disappears.
- 1 ~ 5 sec:  
The scan resumes 1 ~ 5 seconds after the signal disappears.
- HOLD: The scan remains paused for the **Pause Timer** setting, even if the signal disappears.

**NOTE:** Rotate [DIAL] to resume the scan. The **Resume Timer** must be set shorter than the **Pause Timer**, otherwise this timer does not work properly.

\*These settings can be separately set to A band and B band.

## 6 SCANNING

### ■ Starting or canceling the scan

VFO scan: Select the VFO mode and operating mode.

Memory scan: Select memory mode.

1. Push [SCAN].
  - Opens the Scan Type list window.
  - ① If you hold down [SCAN] for 1 second, the last selected scan starts.
2. Select a scan type.  
(Rotate [DIAL] to select it, and then push [ENTER].)

#### ① Information

- In the VFO mode, the decimal point and the selected Scan Type icon blink.
- In the Memory mode the decimal point and the Memory icon blink.
- During a scan:
  - Rotate [DIAL] to change the scanning direction.
  - Push [SCAN] to cancel the scan.



#### VFO scan list

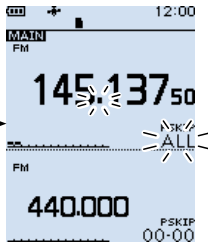
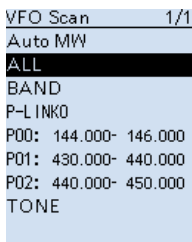

#### Memory scan list

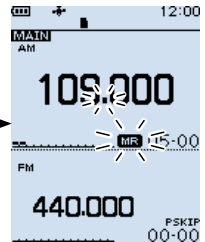
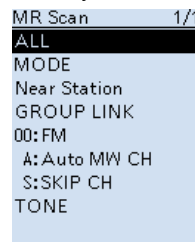

### ■ Convenient function for a Scan

If the Skip setting is set, specified frequencies or memory channels will be skipped during the scan.

- Skip setting for a VFO scan (p. 35)
- Skip setting for a memory channel scan (p. 37)
- Temporary skip setting (p. 35)

Scan resume setting (p. 30)

Voice Squelch Control (VSC) function (p. 45)

## ■ VFO scan

The VFO scan searches for a signal within the specified frequency range.

① See page 31 for details of 'Starting or canceling the scan.'

### ◇ Full scan (ALL)

Repeatedly scans the entire band.

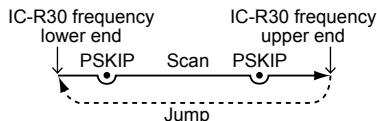

### ◇ Band scan (BAND)

Repeatedly scans the selected band.

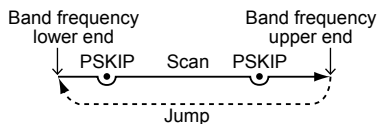

### ◇ Program scan (P00 ~ P49)

Repeatedly scans the selected Program Scan range (P-Scan Edge 00 ~ 49).

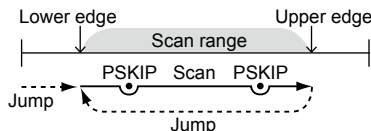

At least one Program Scan range (P-Scan Edges) must be entered to start a Program scan.

([MENU] > Scan > **P-Scan Edge**)

See page 33 for more details.

### ◇ Program Link scan (P-LINK 0 ~ 9)

Sequentially scans the Program Scan ranges. The links are set on the MENU screen. ([MENU] > Scan > **Program Link**)  
See page 34 for more details.

Program scan edges (Example: P00 ~ P10)

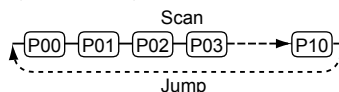

① While scanning, push [BAND] to move to the next Program scan range.

### ◇ Auto memory write scan (Auto MW)

When a signal is received during a VFO scan, the frequency is automatically stored into an Auto Memory Write channel group (A000 ~ A199).

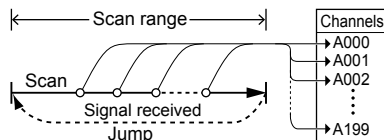

#### ① Information

- The Auto Memory Write scan writes to a memory channel when the scan automatically resumes.
- When no blank channels is left in the Auto Memory Write channel group A (000 ~ 199), the scan automatically cancels.
- When you start this scan, you can skip the following dialog in the Menu screen.  
"Clear All memories in the group A?"  
(The Auto MW Scan will then start.)"

#### ([MENU] > Scan > **Auto MW SCAN Memory Clear**)

OFF: Writes to a blank channel in the group A.

Display Dialog: Display dialog to confirm.

ON: Clears all memories in the group A.

## 6 SCANNING

### ◇ Entering Program Scan ranges

You can enter the upper and lower frequency edges for a Program scan.

Each Program Scan range has its own tuning step, operating mode, and RF gain setting.

You can enter up to 50 Program Scan ranges (P-Scan Edge) on the MENU screen.

#### [MENU] > Scan > P-Scan Edge

1. Push [MENU].
2. Select "P-Scan Edge" in the "Scan" menu.  
(Rotate [DIAL] to select it, and then push [ENTER].)
3. Select a blank Program scan range "00" ~ "49."
4. After pushing [QUICK], select "Edit" and then push [ENTER].
  - The "P-Scan Edge" screen is displayed.
5. Select "FREQ LOW" or "FREQ HIGH" to enter the lower edge and higher edge, and then push [ENTER].

#### ① Information

- Rotate [DIAL] to select the item, and push [ENTER] to enter the edit screen.
  - Enter the lower edge and higher edge using the keypad.
  - When the "NAME" is entered, it displays on the Scan Type list window. About editing character, see ADVANCED MANUAL for details.
  - When the "TS" (Tuning Step), "MODE" and/or "RF GAIN" are blanked, they are used the current setting on the VFO mode.  
The "TS" and "MODE" must be set to match with you desired signals, if you are not familiar with them, we recommend to set them to "Auto."
6. After editing contents, select "<<Write>>," and then push [ENTER].
    - The confirmation dialog is displayed.
  7. Select "YES," and then push [ENTER].
    - ① Push [CLEAR] to return to the Main screen.

P-Scan Edge screen

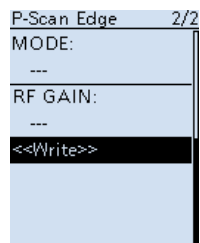
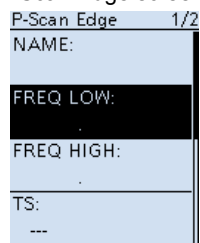

#### TIP: Clearing a Program scan range

To clear the Program scan range, select "Clear" at above step 4, and then push [ENTER].

- The confirmation window is displayed, select "YES" and push [ENTER] to clear the Program scan range.

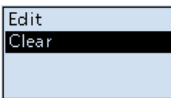

## ◇ About the Program Link Scan

This item sets the Link function for 2 or more Program Scan range to sequentially scan during a Program Link scan. The Program Link scan scans all frequencies in the scan ranges.

### Default settings of the Program Link

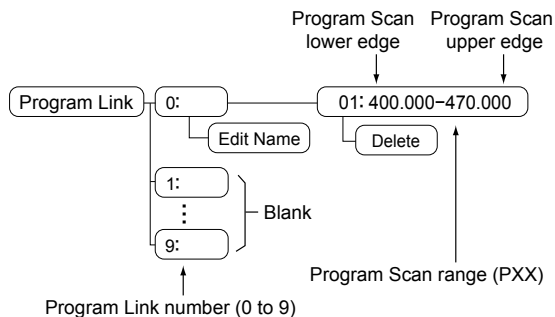

### ① Information

- The Program Link Number screen displays the frequency range.
- You can add a Link setting by pushing [QUICK] when 2 or more Program Scan ranges (P-Scan Edge) are entered.
- When there is no Program Scan range (P00 ~ P49) entered, "Add" is not displayed after pushing [QUICK].

## ◇ Setting the Program Link function

[MENU] > Scan > **Program Link**

1. Push [MENU].
2. Select "Program Link" in the "Scan" menu.  
(Rotate [DIAL] to select it, and then push [ENTER].)
3. Select a Program Link number "0" ~ "9," and then push [ENTER].
  - The Program Link Number screen displays the preregistered Program Scan Ranges.
4. After pushing [QUICK], select "Add" and then push [ENTER].
5. Select the Program scan range that you want to add.  
(Rotate [DIAL] to select it, and then push [ENTER].)
6. Repeat steps 4 and 5 until all Program scan ranges that you want, are added.
7. Push [ENTER] to save the Program Link.
  - ① Push [CLEAR] to return to the Main screen.

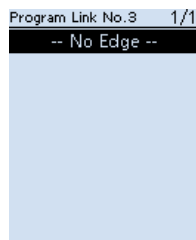

- ① When no Program scan range is selected, "-- No Edge --" is displayed.

## 6 SCANNING

### ◇ Storing Skip frequencies

You can skip unnecessary frequencies during a scan. While a scan is paused and if you want to skip the frequency, you can store it into the Skip channel group S (00 ~ 99) as a Skip channel (PSKIP).

The Scan Skip function speeds up a scan.

1. Start a VFO scan.
    - When a signal is received, the scan pauses.
  2. Hold down [SKIP] until two short beeps sound.
    - The frequency is stored into the Skip channels group.
    - The entered Memory channel number blinks.
    - After storing, the scan resumes.
- ① If there is no blank channel, an error beep sounds, and the frequency is not stored.

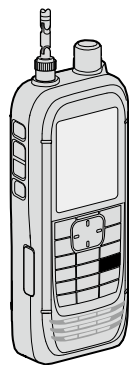

### ◇ Program Skip Scan function

This function enables the receiver to skip the unwanted frequencies that are entered as Memory channels and are set to “PSKIP.” (p. 37)

[MENU] > Scan > Program Skip

1. Push [MENU].
  2. Select “Program Skip” in the “Scan” menu. (Rotate [DIAL] to select it, and then push [ENTER].)
  3. Select the Program Skip function, “ON” or “OFF,” and then push [ENTER].
    - When “ON” is selected, “PSKIP” is displayed above the Memory channel number.
- ① Push [CLEAR] to return to the Main screen.

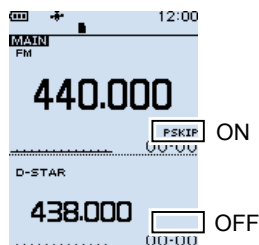

### ◇ Temporary Skip function

This function temporarily skips unwanted frequencies (or memory channels) during a scan for the set period of time, without changing the Skip Channel setting.

- ① You can change **Temporary Skip Timer** on the MENU screen. (Default: 5 min)  
([MENU] > Scan > **Temporary Skip Timer**)

1. Start a scan.
    - When a signal is received, the scan pauses.
  2. After pushing [QUICK], select “Temporary Skip” and then push [ENTER].
    - The scan automatically resumes.
- ① After the Temporary Skip Timer period ends, the scan is canceled or the receiver is turned OFF, the Temporary Skip function is turned OFF.

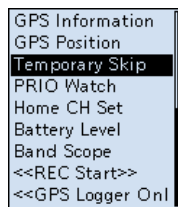

The frequency will be skipped for 5min.

#### TIP:

- Up to 5 Temporary Skip frequencies or Memory channels can be set. When the 6th frequency or Memory channel is set, the oldest setting is automatically deleted.



## Memory scan

The Memory scan searches a signal on the preregistered memory channels.

① See page 31 for details of 'Starting or canceling the scan.'

### ◇ All scan (ALL)

Repeatedly scans all memory channels.

Memory Groups

(00 ~ 99, A: Auto MW CH and S: Skip CH)

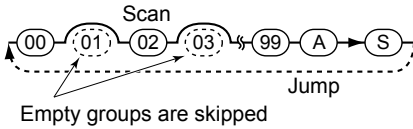

### ◇ Mode scan (MODE)

Scans Memory channels which are entered with the same receiving mode as the currently selected mode.

① The Mode scan scans all memory groups. (Group 00 ~ 99, A: Auto MW CH, S: SKIP CH)

Example: Scanning AM mode  
Memory group 02

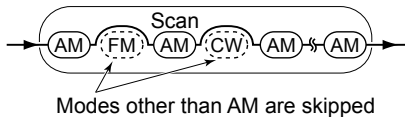

### ◇ Near Station scan (Near Station)

Searches for up to 50 nearby stations that are within 160 kilometer (100 miles) from your location using your GPS position data and the station's position data that is entered in the memory channels.

① Regardless of the SKIP setting, all memory channels will be scanned.

#### NOTE:

- When using the Near Station scan, BE SURE to first receive your own position data, or manually enter your position data.  
([MENU] > GPS > GPS Set > GPS Select)
- If no station is found within a 160 kilometer (100 miles) range, "No station found." is displayed.
- If the last received position data can be used, "GPS is invalid. Search by last valid position" is displayed.

### ◇ Group Link scan (GROUP LINK)

Sequentially scans the memory groups that are set to link on the MENU screen.

Memory Groups

(00 ~ 99, A: Auto MW CH and S: Skip CH)

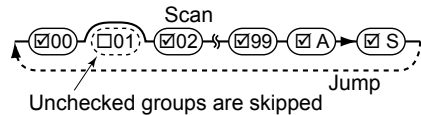

At least 2 groups must be checked to start a Group Link scan.

([MENU] > Scan > Group Link)

See page 37 for more details.

### ◇ Group scan (GROUP 00 ~ 99)

Scans the Memory channels in the selected group. (GROUP 00 ~ 99, A: Auto MW CH, S: SKIP CH)

## 6 SCANNING

### ◇ Setting the Group Link

You can sequentially scan the memory groups which are set to link on the MENU screen.

① In the default setting, all groups are set to link.

#### [MENU] > Scan > Group Link

1. Push [MENU].
2. Select "Group Link" in the "Scan" menu.  
(Rotate [DIAL] to select it, and then push [ENTER].)
3. Select a group, "00" ~ "99," "A: Auto MW CH," "S: SKIP CH."
4. Push [ENTER] to turn the Link function ON or OFF.
  - Display "✓" when the function is set to "ON".
  - ① Push [QUICK] to quickly turn all the groups ON or OFF.
  - ① In the default setting, all groups are set to ON.
  - ① Push [CLEAR] to return to the Main screen.

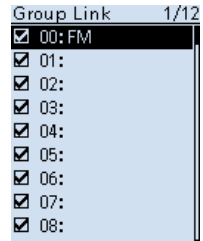

Group Link screen

### ◇ Setting the skip channel

You can set or clear a Skip Channel setting.

The channels that are set as a Skip channel are skipped during a scan.

#### [MENU] > Manage Memory > (Group number)

1. Push [MENU].
2. Select the Group number in the "Memory Manage" menu.  
(Rotate [DIAL] to select it, and then push [ENTER].)
  - ① Group numbers are "00" ~ "99," "A: Auto MW CH" and "S: SKIP CH."
3. Select the memory channel to be skipped.
4. After pushing [QUICK], select "Edit" and then push [ENTER].
5. Select "SKIP," and then push [ENTER].
  - ① Select an option, and then push [ENTER].
  - OFF: Cancels the Skip Channel setting.
  - SKIP: Skipped during a Memory scan.
  - PSKIP: Skipped during both VFO and Memory scans.
6. Select "<<Overwrite>>," and then push [ENTER].
  - The confirmation dialog is displayed, select "YES" and push [ENTER] to save the Memory channel.
  - Select "NO" to just close the confirmation window.
  - ① Push [CLEAR] to return to the Main screen.

Manage Memory screen

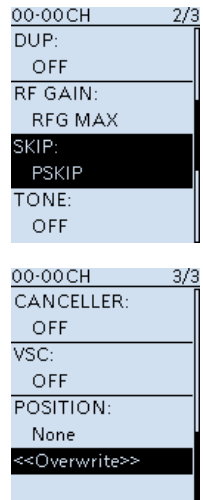

#### TIP:

In the Memory mode operation, you can change the SKIP setting by pushing [SKIP].



OFF  
SKIP  
PSKIP

## ■ About the Priority Watch function

While operating in the VFO mode, or while in the VFO scan, the Priority watch function shortly checks for signals on a selected memory channel (frequency) every 5 seconds. There are 4 ways to use the Priority Watch function, as described below.

- ① When the Dualwatch function is ON, you can independently scan on the MAIN band and SUB band.
- ① While operating the Priority Watch function, you can change the Operating Band, frequency (using [DIAL]), receiving mode, and so on. Also you can start or cancel the VFO scan.

### The Priority Watch function is canceled when:

- Starting the Band scope. (p. 21)
- Either the [CLEAR], [MW], or [F-INP] keys is pushed.
- The “PRIO OFF” is selected in the Quick menu.

### Watching a Priority channel while receiving in the VFO mode

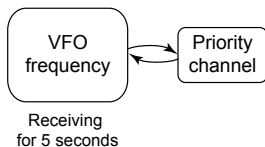

### Watching a Priority channel while scanning in the VFO mode

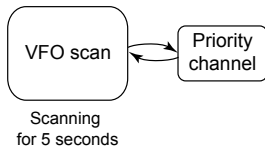

### Memory scanning while receiving in the VFO mode

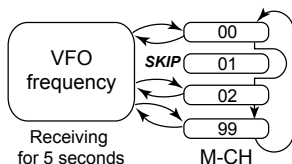

### Memory scanning while scanning in the VFO mode

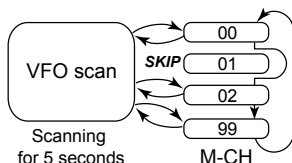

## 6 SCANNING

### ■ Starting or canceling the Priority Watch function

You can start or cancel any scans that are described on the previous page, in the same way.

#### ◇ Starting the Priority Watch

To start the Priority watch, select “ON” or “Bell,” as described below.

- ON: When a signal is received on the Priority channel, the channel is automatically selected.
- Bell: When a signal is received on the Priority channel, beeps sound and the “(••)” icon blinks.

1. Select the Priority channel or Scan type in the Memory mode.
2. Push [QUICK].
3. Select “PRIO Watch” in the Quick menu.  
(Rotate [DIAL] to select it, and then push [ENTER].)
4. Select the option.
  - “PRIO” is displayed.

- When a signal is received on the Memory channel

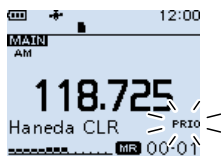

When “ON” is selected

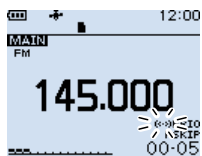

When “Bell” is selected

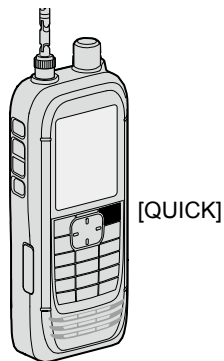

#### ◇ Canceling the Priority Watch

1. Push [QUICK].
2. Select “PRIO Watch OFF” in the Quick menu.  
(Rotate [DIAL] to select it, and then push [ENTER].)
  - “PRIO” disappears.

#### ◇ The Priority Watch and Scanning

When you want to use the combination of the Priority Watch and a scan, you start a Memory scan first, then start the Priority Watch, and a VFO scan in order.

1. Start a Memory scan in the Memory mode.
2. Start the Priority Watch.
  - “PRIO” is displayed.
3. Start a VFO scan.

**NOTE:** The built-in GPS receiver cannot calculate its location if it cannot receive signals from the GPS satellites. Refer to ADVANCED MANUAL for more details on the GPS function.

## ◇ Checking the GPS signal

You can check the satellite acquisition status indicated by the GPS icon.

- The GPS icon blinks when receiving.

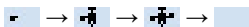

- The GPS icon is displayed when the current location is correctly received.



- ① The time it takes to receive the GPS data may differ, depending on your location.
- ① The GPS icon is not displayed when “GPS Select” is set to “Manual.”  
([MENU] > GPS > GPS Set > **GPS Select**)

### TIP: For the battery power saving

When using the receiver in the same place, you can save the battery power by manually entering your location, or manually read the received GPS position into the MANUAL POSITION screen.

1. Confirm  is displayed. (See above)
2. Select “Manual Position” in the “GPS” menu.  
([MENU] > GPS > GPS Set > **Manual Position**)
3. Push [QUICK], and then select “Capture From GPS” to read the received position into the Manual position.
4. Push D-pad (Left) to return to the “GPS set” screen.
5. Set “GPS Select” to “Manual.”  
([MENU] > GPS > GPS Set > **GPS Select**)
  - The manual position is activated instead of the internal GPS.

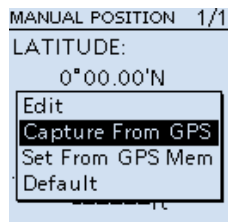

# 7 GPS OPERATION

## ■ Checking your GPS location

You can check your current location.

### ◇ Displaying Position Data

1. Confirm  is displayed.
  2. Push [QUICK].
  3. Select "GPS Position."  
(Rotate [DIAL] to select it, and then push [ENTER].)
    - The GPS POSITION screen is displayed.
  4. Rotate [DIAL].
    - Changes between the MY (My position), RX (Received position), MEM (GPS Memory position), or ALM (GPS Alarm position) screen.
- ① Push [CLEAR] to return to the Main screen.

Example:

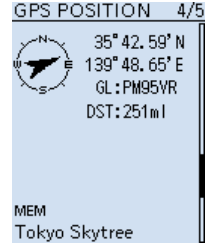

GPS Memory position (MEM) screen

### ◇ About the GPS POSITION screen

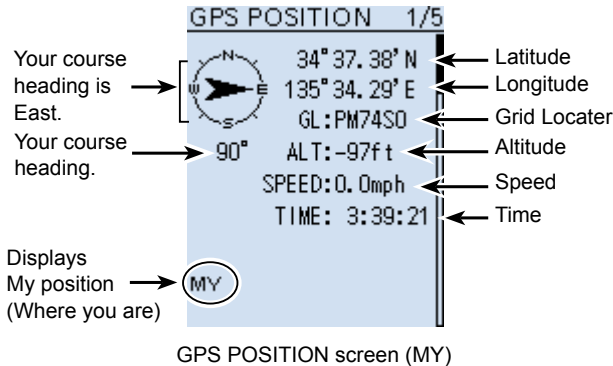

## ■ GPS Logger function

The GPS Logger function enables you to save the position data from a GPS receiver onto a microSD card as a log.

The GPS Logger saves Latitude, Longitude, Altitude, Positioning state, Course, Speed, Date, and Time.

If you use this GPS Logger while driving, you can check your driving history on a mapping application.

### ◇ About the log file

If you have the log file imported into a mapping application, you can display your route as you move on the software map.

- ① The log files may not be compatible with all mapping applications.
- ① See ADVANCED MANUAL for details on copying the log files onto your PC.

#### NOTE:

- The GPS logger function requires a microSD card (User supplied). See pages 4 and 23 for details.
- This function is turned ON as the default setting. Therefore when you insert a microSD card, this function continuously saves the position data from the GPS receiver, even if you turn OFF the receiver, then turn it ON again. To turn OFF the function, do the steps below.
- When the microSD card is full, this function will automatically be paused.

### ◇ Turning OFF the GPS Logger function

[MENU] > GPS > GPS Logger > **GPS Logger**

1. Push [MENU].
2. Select "GPS Logger" in the "GPS" menu.  
(Rotate [DIAL] to select it, and then push [ENTER].)
3. Select "OFF," and then push [ENTER].
  - The GPS logger function is turned OFF.
  - ① Push [CLEAR] to return to the Main screen.

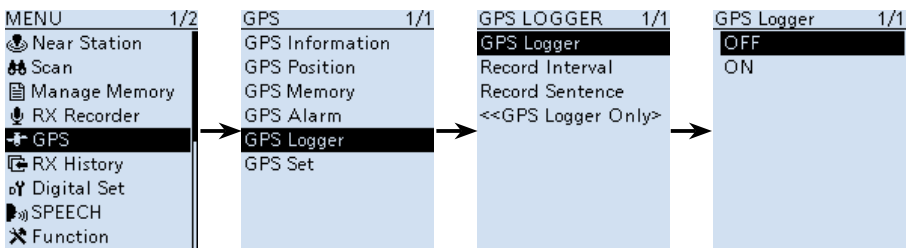

## ■ Operating Bluetooth®

The receiver has a built-in Bluetooth unit. You can connect Bluetooth headsets, or other Bluetooth devices. When you connect a Bluetooth headset to the receiver, you can wirelessly receive.

① The communication range of Bluetooth is approximately 10 meters (33 feet).

**NOTE:** The Bluetooth communication range may vary, depending on the environment where you operate the device.

## ◇ Electromagnetic Interference

When you use a Bluetooth device, pay attention to the following:

Bluetooth devices operate in the 2.4 GHz band. The 2.4 GHz band is also used by other devices, such as Wireless LAN products, microwave ovens, RFID systems, amateur radio stations, and so on.

When using this device near such devices, interference may occur, causing a decrease in communication speed, and an unstable connection. In such cases, use this device away from the other devices, or stop using those devices.

## ◇ Pairing with a device

① These instructions describe pairing with the VS-3 Bluetooth® HEADSET, as an example.

### 1. Turning ON the Bluetooth function

[MENU] > Bluetooth Set > **Bluetooth**

1. Push [MENU].
2. Select "Bluetooth" in the "Bluetooth Set" menu.  
(Rotate [DIAL] to select it, and then push [ENTER].)
3. Select "ON," and then push [ENTER].  
① Push [CLEAR] to return to the Main screen.

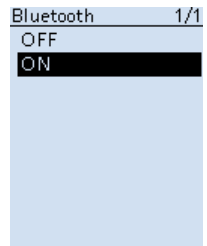

### 2. Entering the VS-3 Pairing mode

- ① Confirm the VS-3 is turned OFF, before entering the Pairing mode.
- Hold down the VS-3's [PWR] button for 6 seconds.
  - ① A melody sounds when the VS-3 is turned ON.
  - ① The LED alternatively blinks red and blue, and then the VS-3 enters the pairing mode.



### 3. Pairing and connecting a Bluetooth headset

[MENU] > Bluetooth Set > Pairing/Connect > **Device Search**

1. Push [MENU].
2. Select "Device Search" in the "Bluetooth Set" menu. (Rotate [DIAL] to select it, and then push [ENTER].)
3. Select "Search Headset," and then push [ENTER].
  - The receiver starts searching for a headset.
4. Select a headset to pair, and then push [ENTER].
  - A confirmation dialog is displayed.
5. Select "YES," and then push [ENTER].
  - "✔" is displayed if the headset is correctly connected.
  - ① Push [CLEAR] to return to the Main screen.

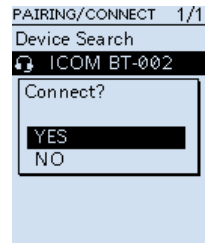

#### TIP:

#### Auto Connect function

The receiver automatically connects to a paired Bluetooth device.

[MENU] > Bluetooth Set > **Auto Connect**

#### Re-searching Bluetooth device

"No Device Found" is displayed if the receiver could not find a Bluetooth device.

1. Push [QUICK].
2. Select "Re-search." (Rotate [DIAL] to select it, and then push [ENTER].)

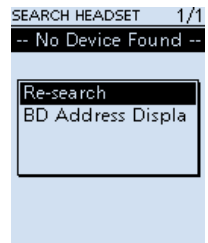

### ◇ Disconnecting a paired device

You can disconnect a paired Bluetooth device if it is not being used.

[MENU] > Bluetooth Set > **Pairing/Connect**

1. Push [MENU].
2. Select "Pairing/Connect" in the "Bluetooth Set" menu. (Rotate [DIAL] to select it, and then push [ENTER].)
  - Paired devices are displayed.
  - ① "✔" is displayed, if the device is connected.
3. Select a device to disconnect, and then push [ENTER].
  - A confirmation dialog is displayed.
4. Select "YES," and then push [ENTER].
  - "✔" disappears.
  - ① Push [CLEAR] to return to the Main screen.
  - ① To re-connect a device, select the device on the Paring list again.

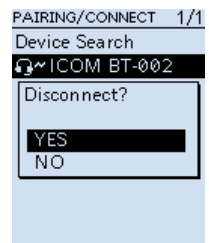

## 8 OTHER FUNCTIONS

### ■ Operating Bluetooth®

#### ◇ Unpairing a device

Before unpairing a connected headset or device, disconnect it.

[MENU] > Bluetooth Set > **Pairing/Connect**

1. Push [MENU].
2. Select "Pairing/Connect" in the "Bluetooth Set" menu.  
(Rotate [DIAL] to select it, and then push [ENTER].)
  - Paired devices are displayed.
3. Select a device to unpair, and then push [QUICK].
4. Select "Delete," and then push [ENTER].
  - A confirmation dialog is displayed.
5. Select "YES," and then push [ENTER].
  - ① Push [CLEAR] to return to the Main screen.

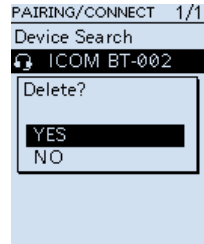

### ■ Using the Noise Blanker (NB)

The Noise blanker function eliminates pulse-type noise such as the noise from car ignitions.

- ① The function is usable in the LSB, USB, and CW modes.

[QUICK] > **NB**

### ■ Using the Automatic Noise Limiter (ANL)

The Automatic Noise Limiter function reduces noise components while receiving.

- ① The function is usable in the AM and AM-N modes.

[QUICK] > **ANL**

### ■ Using the Automatic Frequency Control (AFC)

The Automatic Noise Limiter function reduces noise components while receiving.

- ① The function is usable in the FM, FM-N, and WFM modes.

[QUICK] > **AFC**

### ■ Using the Voice Squelch Control (VSC)

The Voice Squelch Control function opens the squelch, or stops a scan only when voice components are detected in the signal. It is convenient to receive only voice communications.

- ① The function is usable in the FM, FM-N, WFM, AM, and AM-N modes.

[QUICK] > **VSC**

**NOTE:** The VSC function is designed to not detect a continuous audio signal. When receiving a signal such as a radio broadcast program that contains a continuous audio signal, the received audio may be broken up. In such case, turn OFF the VSC function.

## ■ Using a Weather channel (For only the USA version)

The receiver has 10 preset Weather channels. You can use these channels to monitor broadcasts from the National Oceanographic and Atmospheric Administration (NOAA). The receiver automatically detects a Weather alert tone on the selected Weather channel, or while scanning.

### ◇ Selecting a Weather channel

[QUICK] > **Weather CH**

1. Push [QUICK].
2. Select "Weather CH."  
(Rotate [DIAL] to select it, and then push [ENTER].)  
• A weather Channel is displayed.
3. Rotate [DIAL] to select a Weather channel.
  - ① Push [SCAN] to start a Weather channel scan.
  - ① Push [CLEAR] to return to the Main screen.

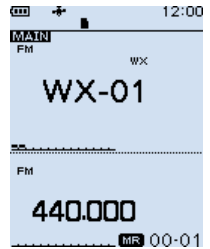

8

### ◇ Receiving a Weather Alert

NOAA broadcast stations transmit weather alert tones before important weather announcements.

When the Weather Alert function is ON, the selected weather channel is monitored every 5 seconds for an announcement.

- ① When the alert is received, "WX" and "ALT" alternately blink.

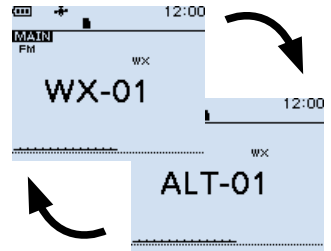

A WX Alert received on channel "01."

## ■ Resetting

Occasionally, erroneous information may be displayed. This may be caused by static electricity or by other factors.

If this problem occurs, turn OFF the receiver. After waiting a few seconds, turn ON the receiver. If the problem still exists, perform a Partial reset, as described below.

If the problem still exists after a Partial reset, perform an All reset.

### The resets affect the following:

<b>Partial reset</b>	Settings on the MENU screen, receive history log, operating settings in the VFO mode.
<b>All reset</b>	Settings on the MENU screen, receive history log, operating settings in the VFO mode, Memory channel contents, Programmable Scan edges and GPS memories.

### NOTE:

An All reset clears all data and returns all settings to their factory defaults. Save memory channel contents, setting status, and so on, onto an SD card before doing an All reset. Refer to Section 7 of ADVANCED MANUAL for details.

① The Bluetooth pairing list is not cleared by an All reset.

## ◇ Partial reset

A Partial reset resets operating settings to their default values.

① The following settings are not returned to their default values.

- Memory channels
- Programmable Scan edges
- GPS memories

[MENU] > Others > Reset > **Partial Reset**

1. Push [MENU].
2. Select "Partial Reset" in the "Others" menu.  
(Rotate [DIAL] to select it, and then push [ENTER].)  
• The confirmation dialog is displayed.
3. Select "YES," then push [ENTER].  
• After resetting, the IC-R30 will automatically restart.

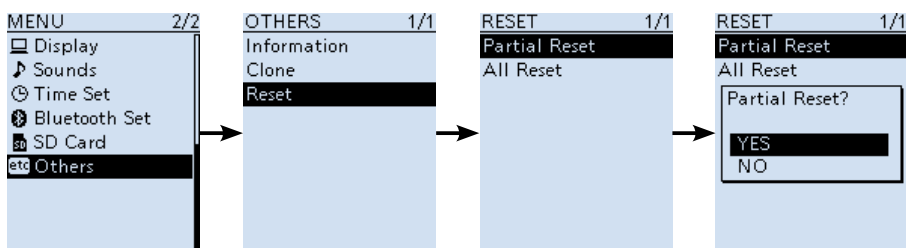

## ■ Troubleshooting

The following chart is designed to help you correct problems that are not equipment malfunctions. If you are unable to locate the cause of a problem, or solve it through the use of this chart, contact your nearest Icom Dealer or Service Center.

PROBLEM	POSSIBLE CAUSE	SOLUTION	REF.
Receiver does not turn ON.	<ul style="list-style-type: none"> <li>The battery pack/case is exhausted.</li> <li>Bad connection of a battery pack/case.</li> <li>The battery polarity is reversed.</li> </ul>	<ul style="list-style-type: none"> <li>Charge the battery pack, or replace the batteries.</li> <li>Clean the battery terminals.</li> <li>Check the polarity in the case.</li> </ul>	<p>p. 2</p> <p>—</p> <p>—</p>
No sound comes from the speaker.	<ul style="list-style-type: none"> <li>Volume level is too low.</li> <li>Earphone mode is ON.</li> <li>The squelch is set too tight.</li> <li>A Tone function (CTCSS, DTCS or Digital Squelch (D.SQ)) is activated.</li> <li>An external speaker is connected to the [SP] jack.</li> <li>A Bluetooth headset is connected.</li> </ul>	<ul style="list-style-type: none"> <li>Push [▲] to increase the level.</li> <li>Set the "Earphone Mode" item to "OFF" on the MENU screen.</li> <li>Set to the threshold level.</li> <li>Turn OFF the Tone function.</li> <li>Remove the external speaker.</li> <li>Disconnect the headset.</li> </ul>	<p>p. 4</p> <p>—</p> <p>p. 14</p> <p>p. 13</p> <p>—</p> <p>p. 44</p>
Sensitivity is too low, and only strong signals are audible.	<ul style="list-style-type: none"> <li>The attenuator is activated.</li> <li>The RF gain is reduced. ("RFG1" ~ "RFG9" is selected.)</li> <li>The coaxial cable is not connected, or shorted. (When an external antenna is used.)</li> </ul>	<ul style="list-style-type: none"> <li>Turn OFF the attenuator.</li> <li>Set the "RF Gain" item to the "RFG MAX" in the QUICK menu window.</li> <li>Check the coaxial cable connection or replace with a new one.</li> </ul>	<p>p. 18</p> <p>p. 18</p> <p>—</p>
Sensitivity is too low on the BC band (1 M).	<ul style="list-style-type: none"> <li>Internal antenna is not selected.</li> </ul>	<ul style="list-style-type: none"> <li>Set the "Bar Antenna" item to "Use" on the MENU screen.</li> </ul>	<p>—</p>
Audio in the SSB mode is unclear or distorted.	<ul style="list-style-type: none"> <li>The incorrect sideband is selected.</li> </ul>	<ul style="list-style-type: none"> <li>Toggle between USB and LSB.</li> </ul>	<p>p. 17</p>
The function of [DIAL] and [▲]/[▼] is swapped.	<ul style="list-style-type: none"> <li>Functions assigned to [DIAL] and [▲]/[▼] are swapped.</li> </ul>	<ul style="list-style-type: none"> <li>Push [DIAL SEL] to switch the functions.</li> </ul>	<p>p. 18</p>
Frequency cannot be set.	<ul style="list-style-type: none"> <li>The Key Lock function is ON.</li> <li>The Memory mode is selected.</li> </ul>	<ul style="list-style-type: none"> <li>Turn OFF the Key Lock function.</li> <li>Push [VFO/MR] to select the VFO mode.</li> </ul>	<p>p. 20</p> <p>p. 16</p>
The displayed frequency is erroneous.	<ul style="list-style-type: none"> <li>The CPU has malfunctioned.</li> <li>External factors have caused a fault.</li> </ul>	<ul style="list-style-type: none"> <li>Reset the receiver.</li> <li>Remove and reattach the battery pack or case.</li> </ul>	<p>p. 47</p> <p>p. 1</p>
A Program Scan does not start.	<ul style="list-style-type: none"> <li>The Memory mode is selected.</li> <li>The same frequency has been programmed in the scan edge channels "FREQ HIGH" and "FREQ LOW."</li> </ul>	<ul style="list-style-type: none"> <li>Push [VFO/MR] to select the VFO mode.</li> <li>Program different frequencies in the scan edge channels.</li> </ul>	<p>p. 16</p> <p>p. 33</p>
A Memory Scan does not start.	<ul style="list-style-type: none"> <li>The Memory mode is not selected.</li> <li>Only one or no memory channel has been programmed.</li> </ul>	<ul style="list-style-type: none"> <li>Push [VFO/MR] to select the Memory mode.</li> <li>Program two or more memory channels.</li> </ul>	<p>p. 16</p> <p>p. 28</p>
The Speech function does not work.	<ul style="list-style-type: none"> <li>Speech Level is set to "0" on the "SPEECH" screen.</li> </ul>	<ul style="list-style-type: none"> <li>Set the "SPEECH Level" item to a higher level on the MENU screen.</li> </ul>	<p>—</p>

# 10 SPECIFICATIONS

## ◇ General

- Frequency coverage:
  - [A band]
  - USA-01 version                    0.100000 ~ 821.999990 MHz
  - 851.000000 ~ 866.999990 MHz
  - 896.000000 ~ 3304.999990 MHz
  - USA-02 version                    0.100000 ~ 3304.999990 MHz
  - EUR-01 version                    0.100000 ~ 3304.999990 MHz
  - [B band]
  - USA-01 version                    108.000000 ~ 520.000000 MHz
  - USA-02 version                    108.000000 ~ 520.000000 MHz
  - EUR-01 version                    108.000000 ~ 520.000000 MHz
- Receive modes:
  - A band (≤1300 MHz)                FM/FM-N/WFM\*1/AM/AM-N/LSB/USB/CW/CW-R/  
D-STAR (DV)/P25/dPMR/NXDN-VN/NXDN-N/DCR
  - (>1300 MHz)                    FM/FM-N/WFM/AM/AM-N
  - B band                                FM/FM-N/AM/AM-N/D-STAR (DV)/P25/dPMR/NXDN-  
VN/NXDN-N/DCR
- Operating temperature range:    -20°C ~ +60°C, -4°F ~ +140°F
- Frequency stability:                Less than ±2.5 ppm (-20°C ~ +60°C, -4°F ~ +140°F)
- Frequency resolution:              0.01, 0.1, 1, 3.125, 5, 6.25, 8.33\*2, 9\*3, 10, 12.5, 15, 20,  
25, 30, 50, 100, 125, 200 kHz
- Number of memory channels:      2000 (in 100 groups)  
+ 400 (Scan edges: 100 (50 pairs),  
Auto Memory Write: 200, and Scan Skip: 100)
- Number of GPS memories:         300
- Power supply requirement:        5.0 V DC (±5%) (Using the supplied USB cable)  
3.6 V DC (Using the supplied battery pack)  
4.5 V DC (Using the battery case)
- Antenna impedance:                50 Ω Unbalanced
- Dimensions (Projections not included):  
58 (W) × 143 (H) × 30.5 (D) mm,  
2.3 (W) × 5.6 (H) × 1.2 (D) in
- Weight (approximate):            200 g, 7.1 oz  
(The antenna and the battery pack not included)

## ◇ Receiver

- Receive system:                      Triple superheterodyne and Down converter  
(A band except WFM)  
Double superheterodyne (B band and WFM)
- Intermediate frequencies:

Band	1st IF (MHz)	2nd (MHz)	3rd (MHz)
A band	266.65, 266.7, 266.75	58.0500 (except WFM) 10.7000 (WFM)	0.4500 (except WFM)
B band	46.3500	0.4500	—

\*1 "WFM" is not selectable, depending on the receiver version and receive frequency.

\*2 For only AIR band. \*3 For only BC band.

① All stated specifications are typical and subject to change without notice or obligation.

- Sensitivity for all versions:

Mode	Frequency range (MHz)	Sensitivity (μV)	Squelch Sensitivity (μV)
SSB/CW (10 dB S/N)	0.495000 ~ 1.899990	0.4	—
	1.900000 ~ 14.999990	0.25	
	15.000000 ~ 29.999990		
	50.000000 ~ 53.999990		
	144.000000 ~ 147.999990		
	430.000000 ~ 449.999990	0.32	
AM (10 dB S/N)	0.495000 ~ 1.899990	2.2	2.2
	1.900000 ~ 14.999990	1.4	1.4
	15.000000 ~ 29.999990		
	118.000000 ~ 136.999990		
FM (12 dB S/N) (1 kHz/±3.5 kHz DEV)	28.000000 ~ 221.999990	0.4	0.4
	222.000000 ~ 832.999990	0.56	0.56
	833.000000 ~ 1299.999990		
	1300.000000 ~ 1999.999990	1.8	1.8
	2000.000000 ~ 2699.999990	1.8	1.8
WFM (12 dB S/N) (1 kHz/±52.5 kHz DEV)	2700.000000 ~ 3304.999990	18	18
	76.000000 ~ 107.999990	1.8	5.6
D-STAR (1% BER)	28.000000 ~ 29.999990	0.71	—
	50.000000 ~ 53.999990		
	144.000000 ~ 147.999990		
	430.000000 ~ 449.999990	1	
	1260.000000 ~ 1299.999990		
NXDN, dPMR, DCR (1% BER)	136.000000 ~ 173.999990	0.71	—
	350.000000 ~ 379.999990	1	
	380.000000 ~ 511.999990		
P25 (5% BER)	136.000000 ~ 173.999990	0.4	—
	400.000000 ~ 469.999990	0.56	
	763.000000 ~ 832.999990	0.71	
	833.000000 ~ 869.999990		

- Selectivity:
  - SSB/CW More than 1.8 kHz/−6 dB
  - AM/FM More than 12 kHz/−6 dB,  
Less than 30 kHz/−60 dB (Less than 1305 MHz),  
Less than 30 kHz/−40 dB (1305 MHz or higher)
  - WFM More than 150 kHz/−6 dB
- Audio output power (3.6 V):
  - External speaker More than 0.2 W (8 Ω load, at 10% distortion)
  - Internal speaker More than 0.4 W (16 Ω load, at 10% distortion)
- Power consumption (3.6V, FM, Single Watch mode, Recording function OFF, GPS function OFF, Backlight OFF):
  - Receiving 330 mA typical
  - Standby 200 mA typical
  - Power saving 100 mA typical

# MENU ITEMS

Refer to ADVANCED MANUAL for each menu item's details. You can download ADVANCED MANUAL from the Icom website.

<http://www.icom.co.jp/world/support/download/manual>

- ① The displayed menu items may differ, depending on the receiver's version or presets. Ask your dealer for details.

<b>Near Station</b>
<b>Scan</b>
Pause Timer
Resume Timer
Temporary Skip Timer
Program Skip
Group Link
P-Scan Edge
Program Link
Auto MW SCAN Memory Clear
<b>Manage Memory</b>
<b>RX Recorder</b>
<<REC Start>>/<<REC Stop>>
Play Files
Recorder Set
RX REC Condition
File Split
REC Operation
Player Set
Skip Time
<b>GPS</b>
GPS Information
GPS Position
GPS Memory
GPS Alarm
Alarm Select
Alarm Area (Group)
Alarm Area (RX/Memory)
GPS Logger
GPS Logger
Record Interval
Record Sentence
<<GPS Logger Only>>
GPS Set
GPS Select
Power Save (Internal GPS)
Manual Position

<b>RX History</b>
<b>Digital Set</b>
Tone Control
D-STAR
P25
dPMR
NXDN
DCR
Digital Monitor
RX Log
RX History Log
CSV Format
RX Record (D-STAR RPT)
D-STAR EMR AF Level
Fast Unmute (NXDN)
<b>SPEECH</b>
D-STAR RX Call Sign SPEECH
DIAL SPEECH
MODE SPEECH
SPEECH Language
Alphabet
SPEECH Speed
SPEECH Level
<b>Function</b>
Auto Power OFF
Power Save
Monitor
Dial Speed-UP
Key Lock
Active Band
Bar Antenna
Earphone Antenna (~ 1.3 G)
CI-V
CI-V Address
CI-V Baud Rate
CI-V Transceive
CI-V USB/Bluetooth
→REMOTE Transceive Address
USB Connect
USB Serialport Function



# MENU ITEMS

<b>Display</b>
Backlight
Backlight Timer
LCD Dimmer
LCD Contrast
RX Popup
P25 RX ID Display
Digital RX Backlight
Scroll Speed
Opening Message
Battery Level (Power ON)
Single Band Display
Display Unit
Display Language**
System Language
<b>Sounds</b>
Earphone Mode
Beep Level
Beep/Vol Level Link
A/B Vol Link
Key-Touch Beep
Home CH Beep
Scan Stop Beep
D-STAR Standby Beep
Sub Band Mute (Main RX)
Scope AF Output
<b>Time Set</b>
Date/Time
DATA
TIME
GPS Time Correct
UTC Offset
<b>Bluetooth Set</b>
Bluetooth
Auto Connect
Pairing/Connect
Device Search
Pairing List*
<<Pairing Reception>>
Headset Set
AF Output
Icom Headset
Data Device Set
Serialport Function
Bluetooth Device Information
Initialize Bluetooth Device

\*Paired devices are displayed.

\*\*Displayed only when “Japanese” is set to the “System Language” item.

<b>SD Card</b>
Load Setting
Save Setting
Import/Export
Import
Export
CSV Format
SD Card Info
Firmware Update
Format
Unmount
<b>Others</b>
Information
Battery Level
Version
Clone
Clone Mode
Reset
Partial Reset
All Reset

<b>A</b>		<b>F</b>	
Accessories .....	x	FCC Information .....	ii
Antenna .....	1	Features .....	i
Attenuator .....	18	Formatting the microSD card.....	5
Audio level.....	4	Frequency Selecting mode.....	15
Automatic Frequency Control (AFC) ...	45	Front panel .....	7
Automatic Noise Limiter (ANL) .....	45	Function display.....	9
Auto Memory Write scan .....	32		
<b>B</b>		<b>G</b>	
Band Scope function .....	21	GPS .....	40
Battery and charging cautions.....	v	About the GPS POSITION screen ..	41
Battery pack		Displaying Position Data .....	41
Attaching .....	1	GPS Logger function .....	42
Capacity of the battery pack .....	2	About the log file .....	42
Charging .....	2	Turning OFF the GPS Logger.....	42
Belt clip.....	1		
Bluetooth®.....	43	<b>H</b>	
Disconnecting a paired device .....	44	Hand strap.....	1
Pairing with a device .....	43		
Unpairing a device .....	45	<b>K</b>	
		Key Lock function .....	20
<b>C</b>		Keypad .....	8
Charging .....	2		
Charging with a USB cable.....	3	<b>M</b>	
Cleaning .....	vii	Memory channel	
		Selecting .....	27
<b>D</b>		Writing.....	28
Decryption function.....	10	Viewing the memory contents.....	27
Default setting.....	12	Memory mode.....	16
Descrambler function.....	10	MENU	
DIAL/VOL Switch function .....	18	MENU screen.....	11
Disposal.....	viii	MENU items .....	47
DTCS codes .....	29	Operation .....	11
Dualwatch function .....	19	Selecting an item .....	12
		microSD card	
<b>E</b>		About the microSD card.....	23
Entering a frequency .....	15	Formatting.....	5
Explicit definitions.....	i	Inserting .....	4
		Removing.....	26
		Mode Speech .....	14
		Monitor function .....	14

<b>N</b>		Scan Types	
Noise Blanker (NB).....	45	All scan (ALL).....	36
<b>O</b>		Auto memory write scan (Auto MW)..	32
Opening Message .....	4	Band scan (BAND).....	32
Operating theory.....	vii	Full scan (ALL).....	32
<b>P</b>		Group Link scan (GROUP LINK) ....	36
Playback screen .....	25	Group scan (GROUP 00 ~ 99).....	36
PRECAUTIONS.....	iv	Memory scan .....	29, 36
Priority watch .....	38	Mode scan (MODE) .....	36
Program scan .....	33	Near Station scan (Near Station) ....	36
Program Link scan.....	34	Program scan (P00 ~ P49) .....	32
<b>Q</b>		Program Skip scan.....	35
Quick Menu window .....	13	Program Link scan (P-LINK 0 ~ 9) ..	32
<b>R</b>		VFO Scan .....	29, 32
Receiving		SD card	
Receive band .....	17	About the microSD card.....	23
Receive frequency .....	15	Formatting .....	5
Receive mode .....	17	Inserting .....	4
Recommendation .....	viii	Removing.....	26
Recording .....	24	Saving a setting data .....	5
Playing back.....	25	Setting	
Recording setting .....	24	Frequency .....	15
Starting recording.....	24	Group Link .....	37
Stopping recording.....	24	Skip channel .....	37
VOICE PLAYER screen .....	25	Skip a frequency temporary.....	35
Resetting .....	47	Specifications .....	49
Partial reset .....	47	Speech function.....	14
<b>S</b>		Squelch.....	14
Scan .....	29	Sweep function .....	22
Memory scan .....	29	<b>T</b>	
Pause timer.....	30	Tone scan .....	29
Priority Watch function .....	35	Troubleshooting.....	48
Program Skip scan.....	35	Tuning step.....	16
Resume timer.....	30	Turning ON.....	4
Skip frequencies .....	35	<b>U</b>	
Starting or canceling the scan.....	31	Unmount (microSD card).....	26
Temporary Skip function .....	35	<b>V</b>	
VFO scan .....	29	VFO mode .....	16
<b>T</b>		Voice Squelch Control (VSC) .....	45
<b>U</b>		<b>W</b>	
<b>V</b>		Weather channel .....	46
<b>W</b>		Writing a Memory channel.....	28

**Count on us!**

